

The Safety of the Nuclear Fuel Cycle



Nuclear Safety

The Safety of the Nuclear Fuel Cycle

Third edition

© OECD 2005
NEA No. 3588

NUCLEAR ENERGY AGENCY
ORGANISATION FOR ECONOMIC CO-OPERATION AND DEVELOPMENT

ORGANISATION FOR ECONOMIC CO-OPERATION AND DEVELOPMENT

The OECD is a unique forum where the governments of 30 democracies work together to address the economic, social and environmental challenges of globalisation. The OECD is also at the forefront of efforts to understand and to help governments respond to new developments and concerns, such as corporate governance, the information economy and the challenges of an ageing population. The Organisation provides a setting where governments can compare policy experiences, seek answers to common problems, identify good practice and work to co-ordinate domestic and international policies.

The OECD member countries are: Australia, Austria, Belgium, Canada, the Czech Republic, Denmark, Finland, France, Germany, Greece, Hungary, Iceland, Ireland, Italy, Japan, Korea, Luxembourg, Mexico, the Netherlands, New Zealand, Norway, Poland, Portugal, the Slovak Republic, Spain, Sweden, Switzerland, Turkey, the United Kingdom and the United States. The Commission of the European Communities takes part in the work of the OECD.

OECD Publishing disseminates widely the results of the Organisation's statistics gathering and research on economic, social and environmental issues, as well as the conventions, guidelines and standards agreed by its members.

* * *

This work is published on the responsibility of the Secretary-General of the OECD. The opinions expressed and arguments employed herein do not necessarily reflect the official views of the Organisation or of the governments of its member countries.

NUCLEAR ENERGY AGENCY

The OECD Nuclear Energy Agency (NEA) was established on 1st February 1958 under the name of the OEEC European Nuclear Energy Agency. It received its present designation on 20th April 1972, when Japan became its first non-European full member. NEA membership today consists of 28 OECD member countries: Australia, Austria, Belgium, Canada, the Czech Republic, Denmark, Finland, France, Germany, Greece, Hungary, Iceland, Ireland, Italy, Japan, Luxembourg, Mexico, the Netherlands, Norway, Portugal, Republic of Korea, the Slovak Republic, Spain, Sweden, Switzerland, Turkey, the United Kingdom and the United States. The Commission of the European Communities also takes part in the work of the Agency.

The mission of the NEA is:

- to assist its member countries in maintaining and further developing, through international co-operation, the scientific, technological and legal bases required for a safe, environmentally friendly and economical use of nuclear energy for peaceful purposes, as well as
- to provide authoritative assessments and to forge common understandings on key issues, as input to government decisions on nuclear energy policy and to broader OECD policy analyses in areas such as energy and sustainable development.

Specific areas of competence of the NEA include safety and regulation of nuclear activities, radioactive waste management, radiological protection, nuclear science, economic and technical analyses of the nuclear fuel cycle, nuclear law and liability, and public information. The NEA Data Bank provides nuclear data and computer program services for participating countries.

In these and related tasks, the NEA works in close collaboration with the International Atomic Energy Agency in Vienna, with which it has a Co-operation Agreement, as well as with other international organisations in the nuclear field.

© OECD 2005

No reproduction, copy, transmission or translation of this publication may be made without written permission. Applications should be sent to OECD Publishing: rights@oecd.org or by fax (+33-1) 45 24 13 91. Permission to photocopy a portion of this work should be addressed to the Centre Français d'exploitation du droit de Copie, 20 rue des Grands Augustins, 75006 Paris, France (contact@cfcopies.com).

FOREWORD

The present edition of The Safety of the Nuclear Fuel Cycle has been prepared by the Working Group on Operating Experience (WGOE) Subgroup on Fuel Cycle Safety (FCS) under the auspices of the OECD Nuclear Energy Agency (NEA) Committee on the Safety of Nuclear Installations (CSNI). The main mission of WGOE/FCS is to advance the understanding of licensing systems, safety philosophy and safety standards for nuclear fuel cycle facilities in NEA member countries. In pursuing this goal, the group exchanges information, identifies critical safety issues and indicates areas where further research or analysis is needed, while periodically reviewing and prioritising fuel cycle safety issues.

The original publication was issued in 1981. Member countries undertook to revise and update the report and a new edition was published in 1993. The current edition represents the most up-to-date analysis of the safety aspects of the nuclear fuel cycle, and replaces the two previous editions.

DISCLAIMER: The reader is cautioned that should there be any discrepancies between the English and French versions of this publication, the English takes precedence as the original text.

The NEA Secretariat wishes to acknowledge the specific services of Dr. Denwood Ross and Mr. Jacques Simonnet who, as expert consultants, provided much of the in-depth technical analysis provided throughout the report as well as many hours of their time editing and compiling the final report. The following WGOE/FCS members also provided meaningful input to various chapters of the report as well as their valuable time at meetings to review and improve the overall contents of the report:

Jean-Paul Minon, ONDRAF/NIRAS, Belgium
Jafir Jaferi, CNSC, Canada
Dorothee Conte, DGSNR, France
Gérard Fraize, IRSN, France
Sachio Fujine, JAERI, Japan
Masashi Kanamori, JNC, Japan
Shingo Matsuoka, JNFL, Japan
Yoshinori Ueda, JNES, Japan
Martin Gaffney, BNFL, United Kingdom
Peter Watson, NII, United Kingdom
Robert Pierson, NRC, United States

The experts listed below kindly made various written contributions, provided comments and assisted in the final edition of the report:

Henri Drymael, AVN, Belgium
Barclay Howden, CNSC, Canada
Rick McCabe, CNSC, Canada
Josef Belac, NRI, Czech Republic

Henri Pailleux, COGEMA, France
Vincent Pertuis, DGSNR, France
Jean-Luc Voitellier, MELOX, France
Valéry Ziegler, retired, France
Karl Gelpke, BfS, Germany
Wolf-Juergen Weber, GRS, Germany
Fancesco P. Michetti, APAT, Italy
Hiroshi Tsuboi, NISA, Japan
Young-Woo Lee, KAERI, Korea
Consuelo Alejano Monge, CSN, Spain
Jose Manuel Conde Lopez, CSN, Spain
Andrew Buchan, BNFL, United Kingdom
John Nobbs, BNFL, United Kingdom
Guy Owen, UKAEA, United Kingdom
Vanice Perin, NRC, United States
Pierre Nocture, Observer, IAEA

This report represents the views of the task force and does not necessarily reflect those of the OECD or its member countries. It is published on the responsibility of the Secretary-General of the OECD.

TABLE OF CONTENTS

Foreword	3
List of Figures	10
List of Tables	12
Chapter 1. INTRODUCTION AND EXECUTIVE SUMMARY	13
1. Introduction.....	13
2. Executive summary	14
Chapter 2. THE NUCLEAR FUEL CYCLE	19
1. Nuclear fuel cycle activities	19
2. Status of the various fuel cycle segments	22
2.1 <i>Uranium mining and milling</i>	22
2.2 <i>Uranium refining and conversion</i>	26
2.3 <i>Enrichment</i>	29
2.4 <i>Fuel manufacture</i>	32
2.5 <i>Spent fuel storage</i>	39
2.6 <i>Spent fuel reprocessing</i>	40
2.7 <i>Radioactive waste management</i>	48
2.8 <i>On-site interim storage of waste</i>	52
2.9 <i>Transportation</i>	56
2.10 <i>Decommissioning</i>	57
3. References.....	64
Chapter 3. SAFETY PRINCIPLES	71
1. Regulatory framework	71
1.1 <i>Governmental responsibilities</i>	72
1.2 <i>Responsibilities of regulatory bodies</i>	73
1.3 <i>Regulations and guides</i>	74
1.4 <i>Licensing</i>	74
1.5 <i>Review and assessment</i>	75
1.6 <i>Regulatory inspection and enforcement</i>	75
1.7 <i>Quality assurance</i>	76
1.8 <i>Emergency preparedness</i>	76
2. Safety issues.....	77
2.1 <i>Radiological safety</i>	77
2.2 <i>Criticality</i>	78
2.3 <i>Chemical hazards</i>	79
2.4 <i>Fire and explosion</i>	79
2.5 <i>Equipment failure</i>	80
2.6 <i>Operator error</i>	80
2.7 <i>External events</i>	81
2.8 <i>Loss of electrical power</i>	81
2.9 <i>Loss of utilities</i>	81

3. Safety assessment procedure.....	81
3.1 Identification of fault situations.....	82
3.2 Fault tree analysis	82
3.3 Assessment of consequences	82
4. Event severity scale.....	83
5. References.....	86
Chapter 4. GENERAL SAFETY	89
1. Radiation	89
1.1 Radiation protection programme.....	90
1.2 Containment and ventilation.....	90
1.3 Containments	91
1.4 Ventilation.....	92
2. Criticality	93
2.1 Criticality safety.....	94
2.2 Factors affecting criticality	95
2.3 Possible abnormalities.....	96
2.4 Assessment philosophy.....	96
2.5 Criticality accident	96
3. Chemical hazards	97
4. Fire and explosion hazards.....	98
4.1 Fire hazards – General.....	98
4.2 Fire hazard analysis	99
4.3 Fire prevention measures	99
4.4 Fire-detection systems	100
4.5 Fire-fighting resources	100
4.6 Periodic inspection and safety instructions	101
4.7 Explosion hazards.....	101
5. Maintenance	101
6. Human factors	102
6.1 Introduction	102
6.2 Definitions.....	103
6.3 Human reliability.....	103
6.4 Ergonomics	104
6.5 Organisational psychology.....	105
7. Effluents	105
8. Environmental considerations.....	106
9. External safety issues	107
9.1 Seismic events	107
9.2 External fires and explosions.....	107
9.3 Accidental aircraft crash	108
9.4 Extreme weather conditions.....	109
10. References.....	110
Chapter 5. SAFETY OF THE FRONT END OF THE FUEL CYCLE	113
1. Uranium mining and milling	113
2. Uranium refining and conversion.....	117
2.1 Radiological protection	117
2.2 Conventional safety.....	118
2.3 Emergency plans.....	120
2.4 Safety management and assessment.....	120
2.5 Waste management and environmental monitoring.....	121

3. Uranium enrichment	122
3.1 Separative work unit (SWU) – A metric for enrichment plants	122
3.2 Enrichment technologies.....	124
3.3 Uranium hexafluoride hazards	130
3.4 Nuclear/radiation hazards.....	131
4. Fuel fabrication	132
4.1 Enriched uranium hexafluoride conversion to UO ₂	132
4.2 Specific safety measures for MOX fuel fabrication facilities.....	134
5. References.....	138
Chapter 6. SAFETY OF THE SPENT FUEL STORAGE	141
1. Wet storage facilities.....	142
1.1 At reactor (AR) pool storage	142
1.2 Away from reactor (AFR) pool storage	142
1.3 Pool storage capacity at reprocessing sites.....	143
1.4 Safety issues with wet storage of spent fuel	143
2. Dry storage facilities	149
2.1 Status.....	149
2.2 Dry wells.....	149
2.3 Metal casks	149
2.4 Silos (concrete casks).....	151
2.5 Vaults	151
2.6 Summary of dry storage experience.....	152
2.7 Safety issues for dry storage facilities	152
3. Areas of future work	152
4. References.....	154
Chapter 7. SAFETY OF FUEL REPROCESSING.....	157
1. General considerations.....	157
1.1 Hazards of nuclear origin.....	159
1.2 Non-nuclear hazards of internal origin.....	165
1.3 Non-nuclear hazards of external origin.....	168
2. Reprocessing of Magnox and alloy fuels	170
2.1 Criticality.....	170
2.2 Fire	170
2.3 Corrosion.....	171
2.4 General	171
3. Reprocessing of uranium oxide fuels	171
3.1 Current situation.....	171
3.2 Safety analysis.....	172
3.3 Operational experience.....	181
4. Mixed oxide fuel (MOX)	184
4.1 Current situation.....	184
4.2 Safety analysis.....	185
5. Fast breeder reactor (FBR) fuel.....	186
5.1 Current situation.....	186
5.2 Safety analysis.....	186
5.3 Operational experience.....	186
5.4 Storage of plutonium and conversion into oxide	187
5.5 Storage of uranium and oxide conversion	189
6. References.....	191

Chapter 8. SAFETY OF THE MANAGEMENT OF RADIOACTIVE WASTE	195
1. General considerations.....	195
2. High-level liquid waste	197
2.1 <i>Storage in liquid form</i>	198
2.2 <i>Safety considerations</i>	201
2.3 <i>Cooling system loss</i>	202
2.4 <i>Containment failure</i>	202
3. High-level solid waste.....	204
3.1 <i>Solidification of waste</i>	204
3.2 <i>Vitrification technology and experience</i>	205
3.3 <i>Safety considerations</i>	209
3.4 <i>Preventive and remedial measures</i>	210
4. Fuel cladding waste – shearing and clarification residues	210
5. Medium-level waste containing plutonium.....	213
5.1 <i>Treatment and conditioning methods</i>	213
6. Management of gaseous effluents.....	217
7. References.....	219
Chapter 9. SAFETY OF ON-SITE WASTE STORAGE	225
1. Vitrified waste.....	225
1.1 <i>Technology and experience acquired</i>	225
1.2 <i>Safety considerations</i>	226
2. Cladding waste.....	228
2.1 <i>Introduction</i>	228
2.2 <i>Magnox cladding swarf</i>	228
2.3 <i>Stainless steel waste</i>	229
2.4 <i>Zircaloy hulls and end-pieces</i>	224
2.5 <i>Graphite waste</i>	230
3. Insoluble residues.....	230
4. References.....	230
Chapter 10. SAFETY OF DECOMMISSIONING OF NUCLEAR FACILITIES	231
1. Decommissioning strategy	231
1.1 <i>Government policies</i>	232
1.2 <i>Timing</i>	233
2. Decommissioning planning.....	233
3. Decommissioning management	234
4. General requirements of safe decommissioning	236
4.1 <i>Safety assessment and safety cases</i>	236
4.2 <i>Radiological protection and ALARA</i>	237
5. Decommissioning technology.....	238
5.1 <i>Characterisation</i>	239
5.2 <i>Decontamination</i>	239
5.3 <i>Dismantling and demolition</i>	240
5.4 <i>Surveillance and maintenance</i>	241
5.5 <i>Final radiological survey/site restoration</i>	241
6. Summary of decommissioning experience	242
7. References.....	242
Chapter 11. SAFETY OF THE TRANSPORT OF RADIOACTIVE MATERIALS	247
1. Safety considerations and regulations.....	247
1.1 <i>Characteristics of various types of packages</i>	247

1.2	<i>Basis for safety requirements</i>	249
1.3	<i>Assessment of safety documents</i>	250
2.	Industrial participants.....	250
3.	Special features of transport of spent fuel.....	251
3.1	<i>Heat transfer</i>	252
3.2	<i>Radiation shielding</i>	252
3.3	<i>Mechanical design</i>	252
4.	Transport of vitrified high-level waste.....	253
5.	Safety record of transporting radioactive material.....	253
5.1	<i>Highway accident, Springfields, Massachusetts, United States (1991)</i>	254
5.2	<i>Train collision, Kenefick Siding, Kansas, United States (1997)</i>	254
5.3	<i>Aircraft fire, Newburg, New York, United States (1996)</i>	254
5.4	<i>Trolley/train collision, Montpellier railway station, France (1983)</i>	254
5.5	<i>Mont-Louis shipwreck, North Sea (1984)</i>	254
5.6	<i>MSC Carla shipwreck, Atlantic Ocean (1997)</i>	255
5.7	<i>Package and vehicle contamination, Europe (1998)</i>	255
5.8	<i>Highway truck fire, Langres, France (1999)</i>	255
6.	References.....	255
Chapter 12.	SAFETY RECORDS OF FUEL CYCLE FACILITIES	257
1.	Personnel irradiation dose.....	257
1.1	<i>Uranium mining and milling</i>	257
1.2	<i>Enrichment</i>	257
1.3	<i>Uranium dioxide fuel element fabrication</i>	259
1.4	<i>Mixed oxide fuel element fabrication</i>	262
1.5	<i>Reprocessing</i>	263
2.	Waste discharges.....	266
2.1	<i>Uranium mining and milling</i>	267
2.2	<i>Enrichment</i>	267
2.3	<i>Uranium dioxide fuel element fabrication</i>	267
2.4	<i>Mixed oxide fuel element fabrication</i>	268
2.5	<i>Reprocessing</i>	269
3.	Major incidents.....	272
3.1	<i>Criticality incidents</i>	272
3.2	<i>Release of UF₆</i>	278
3.3	<i>Fire and exothermic reactions</i>	281
3.4	<i>Leakage of radioactive material, contamination</i>	291
3.5	<i>Loss of power supply</i>	296
3.6	<i>Incidents of external origin</i>	297
4.	References.....	297
MAIN CONCLUSIONS		299
1.	General context of the past decade.....	299
2.	General view of nuclear safety during the past decade.....	299
3.	Evolution by area.....	301
4.	General conclusion.....	302
<i>Appendix 1</i>	<i>– Fuel Cycle Facility Listing of OECD Countries – Status 2002-2003</i>	<i>303</i>
<i>Appendix 2</i>	<i>– Glossary of Terms</i>	<i>309</i>
<i>Appendix 3</i>	<i>– List of Abbreviations</i>	<i>317</i>

LIST OF FIGURES

Figure 2.1	The nuclear fuel cycle.....	20
Figure 2.2	View of a typical PWR fuel assembly	22
Figure 2.3	World uranium reserves.....	23
Figure 2.4	World uranium production – Distribution by company (1998).....	23
Figure 2.5	Western world production of uranium.....	24
Figure 2.6	Uranium extraction from ores.....	25
Figure 2.7	Uranium refining and conversion to hexafluoride	27
Figure 2.8	UF ₆ to UO ₂ conversion processes	32
Figure 2.9	MIMAS MOX fuel fabrication process	35
Figure 2.10	Flow sheet of PNC (now JNC) co-conversion process.....	37
Figure 2.11	MOX fuel fabrication process at PFPF (Japan)	38
Figure 2.12	Reprocessing operations	41
Figure 2.13	PUREX flow sheet.....	45
Figure 2.14	Uranium and plutonium conversion to UO ₂ , PuO ₂ and UO ₂ -PuO ₂ for MOX production	46
Figure 2.15	Fission products solution tank in the R7 facility	48
Figure 2.16	The AVM continuous vitrification process.....	51
Figure 2.17	Glass pouring in La Hague R7 facility	51
Figure 2.18	EDS LLW drums storage at La Hague	55
Figure 3.1	The major INES scales	84
Figure 3.2	Detailed explanation of INES scales.....	85
Figure 5.1	Ore extraction – Raise bore method.....	114
Figure 5.2	Tailings management facility at Key Lake	116
Figure 5.3	Idealised <i>in situ</i> leach process in section at Crow Butte site	116
Figure 5.4	Feed rate and SWU relationships.....	123
Figure 5.5	Portsmouth cell housing after fire.....	126
Figure 5.6	Diagram of a gaseous centrifuge.....	127
Figure 5.7	Cascade of centrifuges	127
Figure 5.8	The principle of the AVLIS process	129
Figure 5.9	The AVLIS system	129
Figure 6.1	Pool storage	141
Figure 6.2	Dry spent fuel storage in steel casks at Emsland (Germany).....	150
Figure 7.1	Aerial view of the La Hague UP3-A Plant	157
Figure 7.2	EMEM (mobile equipment replacement cask) in the AD2 facility at La Hague...	161
Figure 7.3	View of the wheel of the dissolver used in UP2-800 and UP3-A	163
Figure 7.4	General view of an evaporator.....	180
Figure 7.5	View of a plutonium evaporator at Dounreay	180
Figure 7.6	Pulsed column in the T2 facility at La Hague	182
Figure 7.7	Subcritical harp-shaped tanks for the storage of plutonium nitrate	187
Figure 8.1	Compacting press in the ACC facility at La Hague	196
Figure 8.2	Volume of waste conditioned for disposal in UP3-A	197
Figure 8.3	Sectional diagram of a HLLW tank.....	199
Figure 8.4	View of an HLLW tank with cooling coils.....	199

Figure 8.5	HLLW tank showing bottom cooling jackets	200
Figure 8.6	Canister for vitrified HLW	206
Figure 8.7	R7 Vitrification plant in La Hague: inside view of one of the calcination and vitrification cells	207
Figure 8.8	Containers on rotary pouring station carousel of vitrification line 3 of WVP during inactive tests	208
Figure 8.9	Bitumen drums filling station in STE3 facility (La Hague)	214
Figure 8.10	MDS: Combustion chamber	217
Figure 9.1	Vitrified waste interim storage room	225
Figure 11.1	Typical type B package.....	248
Figure 12.1	Average dose (external + internal) for utility workers – Juzbado fuel fabrication facility, Spain.....	261
Figure 12.2	Collective dose per GWy produced by the treated fuel, La Hague, France.....	264
Figure 12.3	Collective dose, Sellafield site, United Kingdom.....	265
Figure 12.4	Average individual dose, Sellafield site, United Kingdom.....	266
Figure 12.5	Total alpha discharges to the North-East Atlantic	266
Figure 12.6	Total beta discharges to the North-East Atlantic	267
Figure 12.7	Gaseous waste discharges – Doses to public reference groups, Juzbado fuel fabrication facility, Spain	267
Figure 12.8	Liquid waste discharges – Doses to public reference groups, Juzbado fuel fabrication facility, Spain	268
Figure 12.9	Waste liquid discharges, La Hague, France.....	269
Figure 12.10	Alpha liquid waste discharges, Sellafield, United Kingdom	271
Figure 12.11	Beta liquid waste discharges, Sellafield, United Kingdom.....	271

LIST OF TABLES

Table 2.1	World uranium production by company	24
Table 2.2	Interim storage facilities	54
Table 2.3	Amount of materials from decommissioning at Eurochemic up to 2003 (in kg/y)	62
Table 2.4	Occupational radiation doses from decommissioning at Eurochemic	63
Table 5.1	Overview of uranium enrichment methods.....	124
Table 6.1	Comparison of conditions for water reactor fuel	143
Table 7.1	Oxide fuel reprocessing statistics.....	172
Table 7.2	Forecast of medium-term evolutions in fuel (France)	185
Table 8.1	Decontamination factors in operation – Vitrification pilot plants	209
Table 10.1	Differences between decommissioning and operational states.....	235
Table 11.1	Package response for accidents reported in the United States between 1971 and 1996.....	253
Table 11.2	Package response for accidents and incidents reported in France between 1997 and 1998.....	253
Table 12.1	Average annual exposure for Japanese enrichment and fuel fabrication facilities	257
Table 12.2	Average annual exposure for US fabrication, processing, and enrichment employees	258
Table 12.3	Occupational radiation doses – Dessel uranium fuel plant, Belgium	259
Table 12.4	Occupational external doses – Romans uranium fuel plant, France	259
Table 12.5	Occupational internal doses – Romans uranium fuel plant, France.....	260
Table 12.6	Occupational radiation doses – Lingen uranium fuel plant, Germany	260
Table 12.7	Average dose for utility workers – Juzbado fuel fabrication facility, Spain.....	261
Table 12.8	Occupational radiation doses – Springfields fuel manufacturing plant, United Kingdom	262
Table 12.9	Occupational radiation doses – Dessel MOX fuel manufacturing plant, Belgium	262
Table 12.10	Total occupational doses (contractors inc.) – MELOX fuel plant, France	263
Table 12.11	Occupational doses MELOX workers – MELOX fuel plant, France	263
Table 12.12	Average annual exposure for Japanese reprocessing facilities	264
Table 12.13	Waste discharges, Radiation doses to members of the public – Springfields fuel manufacturing plant, United Kingdom	268
Table 12.14	Waste atmospheric discharges, La Hague, France (in Bq)	269
Table 12.15	Waste discharges, JNC, Tokai mura, Japan.....	270

Chapter 1

INTRODUCTION AND EXECUTIVE SUMMARY

1. Introduction

This report addresses the safety and technical aspects of fuel cycle operations and provides information on operating practices. The report is subdivided into the following chapters:

- Chapter 1: Introduction and executive summary
- Chapter 2: The nuclear fuel cycle
- Chapter 3: Safety principles
- Chapter 4: General safety
- Chapter 5: Safety of the front end of the fuel cycle
- Chapter 6: Safety of the spent fuel storage
- Chapter 7: Safety of fuel reprocessing
- Chapter 8: Safety of the management of radioactive waste
- Chapter 9: Safety of on-site waste storage
- Chapter 10: Safety of decommissioning of nuclear facilities
- Chapter 11: Safety of the transport of radioactive materials
- Chapter 12: Safety records of the fuel cycle facilities
- Main conclusions
- Appendix 1: Listing of facilities as for 2002-2003
- Appendix 2: Glossary of terms
- Appendix 3: List of abbreviations

Each of the technical chapters can be read separately. The organisation of the report follows that of the previous version of this report, which was published in 1993.

Extensive reference was then made to the proceedings of the international conferences held during the 1980s, particularly the Joint American and European Nuclear Societies meeting in 1982, the European Nuclear Society meetings in 1986 and 1990, and the RECOD (REtraitement [Reprocessing], COMbustible [Fuel], Déchets [Waste]) Conferences in 1987 and 1991. Most of these references are still pertinent.

It should be noted that there are differences between the regulatory policies and practices of each OECD member country; therefore, only typical examples of these differences are described in this report. It should also be taken into account that nuclear fuel cycle facilities, compared with

reactors, are normally operated under both low-pressure and low-temperature conditions as well as under subcritical conditions. Usually, therefore, deviations from normal operating conditions of fuel cycle facilities are less likely to develop rapidly into dangerous situations.

2. Executive summary

This report is summarised below, by chapter.

Chapter 2: The nuclear fuel cycle

A general overview is given of the various activities that make up the nuclear fuel cycle with the exception of irradiation of nuclear fuel in the nuclear power plant. Radioactive waste management as a whole and its environmental impact are outside the scope of this report, but waste management aspects that are directly connected to on-site fuel cycle facility operation and safety are discussed in detail.

Chapter 2 also describes fundamental principles of the operations, highlights the important safety issues, and reviews the present industrial state of the art. Each phase of the nuclear fuel cycle, starting with uranium mining and milling, followed by enrichment, fuel fabrication, irradiated-fuel storage and fuel reprocessing, waste handling, waste on-site storage, radioactive material transportation and decommissioning of installations was prepared with both the non-specialist scientist and generally educated public in mind.

Chapter 3: Safety principles

This chapter examines the safety philosophy adopted internationally to ensure high standards of safety in the nuclear fuel cycle. After a short review of the basic safety principles, an overview is given of the governmental and regulatory bodies' responsibilities in matters of regulations, guides, licensing procedures and follow-up during operation.

Safety regulations, though specific for each nation, have the common goals of protection of the workers and the public, confinement of radioactive contamination within safe barriers and the analysis and mitigation of the impact of abnormal occurrences. Internal events caused by physicochemical, nuclear, mechanical, natural, and human origin are discussed generically.

The topic of safety assessment is reviewed by going through the general stages of identification, analysis, and consequence assessment of fault situations by deterministic and probabilistic methods.

The severity scale (International Nuclear Event Scale, INES) developed internationally jointly by the Nuclear Energy Agency (NEA) and the International Atomic Energy Agency (IAEA) is examined and its applicability illustrated. This scale is intended to facilitate greater mutual understanding among the nuclear community, the media and the public, using simple and comprehensible classifications of the nuclear incidents and accidents.

Chapter 4: General safety

This chapter not only discusses general safety, but also specific safety aspects common to various portions of the nuclear fuel cycle.

Industrial nuclear facilities are subject to internal and external hazards that are adequately designed against. Confinement and ventilation are very important safety requirements that are generally applicable to all fuel cycle facilities. Criticality is one of the safety hazards associated with the industrial use of fissile materials, against which specific precautions are taken; the factors affecting neutron production and moderation are reviewed in a generic way.

Fire and explosion hazards encountered in fuel cycle facilities are also identified and preventive measures are discussed on their merits.

Significant progress has been made in the mitigation of the effects of external hazards. The items discussed are seismic events, explosions and fires, accidental aircraft crashes, extreme weather conditions, and floods.

Chapter 5: The safety of the front end of the fuel cycle

In the front end of the fuel cycle, all activities are focused on fuel fabrication. Uranium mining and milling is the first step of the fuel cycle, which involves the handling of large quantities of uranium-bearing ores; at this stage, hazards are primarily associated with the inhalation of uranium-bearing dusts, gamma radiation and the potential exposure of workers to radon (^{222}Rn) and its daughter products.

Uranium refining and conversion to uranium hexafluoride (UF_6) is the ensuing industrial activity. The primary hazard is of chemical nature, because of the handling of hexafluoride and gaseous fluorine compounds. Control of these hazards is well understood, as in the conventional chemical industry.

Enrichment of uranium is carried out industrially by either a diffusion process or a centrifuge process. Development work on laser enrichment continues to take place, though some countries have abandoned it because of technological difficulty. The release of UF_6 caused by the failure of components in the plant is the main abnormal event which has to be considered. Containment of UF_6 is carefully designed to prevent its accidental release.

Fuel fabrication is the last step of the front end of the fuel cycle by which UF_6 is transformed into uranium dioxide (UO_2), which is used in the manufacture of fuel elements. For some applications, e.g. mixed oxide (MOX) or fast breeder reactor (FBR), UO_2 is mixed with plutonium dioxide (PuO_2). In-plant accidents considered at the design stage are: UF_6 release, criticality, and explosion. The use of reprocessed uranium normally involves only a slightly increased radiological hazard, which is taken into account in facility design. The dominant hazard in MOX fuel fabrication is release of plutonium to the plant or the environment. Special attention is devoted to the discussion of a multi-barrier system that protects plant workers and the public from plutonium contamination in both normal and abnormal conditions.

The back end of the fuel cycle starts at the unloading of spent fuel from nuclear power plant. It includes the transport of spent fuel, storage, reprocessing, radioactive waste treatment, and on-site storage of waste.

Chapter 6: The safety of the spent fuel storage

Very extensive experience has been gained in wet storage of spent fuel and only small hazards have been experienced, e.g. contamination of pool water or leakage of contaminated water.

Abnormal internal occurrences are loss of electrical power supply, fuel element handling faults, criticality, and loss of coolant; appropriate protective measures are described based on available technology. Internally generated hazards such as loss of pool water or crane collapse also require careful evaluation.

As far as the integrity of storage pools is concerned, there could be a hazard caused by external or internal events. The risk is, however, avoided or minimised by both appropriate site selection and design of the facility.

Dry storage of cooled spent fuel is also a safe practice. Gradually increasing experience is gained with “away from the reactor”, vault type or container storage and independent spent fuel storage facilities at selected reactor sites.

Chapter 7: The safety of fuel reprocessing

Spent fuel reprocessing is one of the major fuel cycle options. Worldwide experience has been gathered, particularly in the OECD countries. Large industrial plants are operated in France (La Hague) and the United Kingdom (Sellafield), or are under construction in Japan (Rokkasho mura).

In the United States, reprocessing technology for defence purposes is currently operational in stand-by plants.

A generic analysis is given of the internal and external hazards specific for reprocessing plants as well as the means to control the risk, among them fire and explosion, which receive the most attention because of the use of industrial quantities of flammable solvents and chemical reagents in the PUREX process (Plutonium URanium EXtraction).

Reprocessing-recycling of UO₂ fuels is discussed in detail, highlighting the hazards during mechanical operations, dissolution of fuel, solvent extraction, and waste treatment. The present status of the technology coping with these hazards and the means to reduce the risk are reported. Some developments in reprocessing plants (UP3-A, THORP, Rokkasho Reprocessing Plant) are listed in detail.

Specific concerns associated with reprocessing of LWR MOX and FBR MOX fuel such as criticality and high neutron emission are discussed. Safety issues related to the production and storage of plutonium are reviewed.

Chapters 8 and 9: The safety of the management and storage of radioactive waste

Radioactive waste final disposal is a subject in its own that is then outside the scope of this document. Discussion of related safety aspects has been limited to fuel cycle installations on-site aspects: high-level liquid waste (HLLW) storage, waste solidification processes (primarily vitrification), and the on-site storage of vitrified high-level waste (HLW). The on-site storage of cladding waste and medium active waste containing plutonium is also addressed.

The safety issues associated with the storage of HLLW are primarily loss of cooling and containment failure, but preventive measures, technical improvements, and technical development have considerably reduced the risks associated with this form of storage.

The solidification of HLLW by vitrification is the most widely used technology. The safety problems are generally limited to contamination of equipment and hot cells with a very small external contamination hazard.

Zircaloy cladding, Magnox swarf, and insoluble residues are types of HLW that need to be stored in carefully controlled conditions in order to avoid self-heating reactions which might lead to a resultant pyrophoric hazard. The conditioning methods, essentially incorporation into concrete or compaction, are acceptable for interim storage if sufficient provision has been made for release of gases resulting from reaction or radiolysis.

Waste treatment methods include bituminisation of sludges, incineration of plutonium residues, and chemical recovery of plutonium from heavily contaminated waste by acid digestion.

Gaseous discharges from reprocessing (in normal operation) constitute only a small source of radiation dose to individuals.

Chapter 10: The safety of decommissioning

Decommissioning of nuclear facilities is becoming an increasingly important activity as plants age and become obsolete. Special emphasis is put on those aspects of decommissioning fuel cycle facilities, which are by nature and construction quite different from nuclear power plants.

The radiological protection aspects of decommissioning are very important and are currently being addressed by OECD countries.

Chapter 11: The safety of the transport of radioactive materials

Well-established international regulations exist for the transport of radioactive materials, in particular fresh and spent fuel elements, plutonium, and waste materials. Stringent safety regulations are based on two main principles:

- The required safety levels are achieved by appropriate package design, without consideration of the safety of the transport mode.
- The potential hazard defines the required safety of the package. The packaging of nuclear materials is designed to withstand very severe drop and fire without breach of containment. Specific attention is given to heat dissipation when transporting spent fuel or vitrified waste and to criticality prevention and containment when carrying fissile materials such as plutonium. Transportation by sea and air is receiving more attention than hitherto and is briefly discussed.

Chapter 12: Safety records of fuel cycle facilities

The experience gained from plant operation constitutes a valuable basis for further safety analyses and design improvements. In the first Section, data are provided on personnel radiation doses in representative fuel cycle facilities.

A second Section reviews the discharges to the environment for some individual fuel cycle facility.

The third Section describes, in a summarised form, incidents that have been reported. A series of incidents from the period 1956-90, which were identified in the previous OECD report, and more recent incidents from the 1990-2002 period are included. For each of the described incidents, the technical origin is given and the lessons learned are summarised.

Main conclusions

This chapter reviews the main issues in the different fuel cycle operations and sketches future considerations for fuel cycle safety. The general conclusion is that fuel cycle industry has found its maturity and a satisfactory level of safety. This does not mean that nothing is to be done: human factors, inter alia, is an open promising subject.

Chapter 2

THE NUCLEAR FUEL CYCLE

1. Nuclear fuel cycle activities

The nuclear fuel cycle comprises a number of interrelated activities that together make up the fuel cycle. These activities include:

- uranium mining and milling;
- uranium refining and conversion to uranium hexafluoride;
- uranium enrichment;
- fuel fabrication (including MOX fuel);
- reactor operation;
- spent fuel storage;
- spent fuel reprocessing;
- decommissioning of nuclear facilities;
- radioactive waste management and disposal options (including for spent fuel).

Reactor operation is conventionally not included in the so-called nuclear fuel cycle (named hereafter “fuel cycle”).

The long-term management of radioactive waste is a very broad field, widely covered in several places, that is not addressed in this report. Only the safety aspects associated with processing and storing waste in the short term on the site of fuel cycle facilities are treated in this report.

Disposal of waste is an important issue for all nuclear fuel cycle options. Three main types of fuel cycles are commonly identified, depending on whether or not the spent fuel is reprocessed, and if so, to what type of reactor the extracted plutonium and uranium are recycled. Figure 2.1 shows a diagrammatic representation of the three main fuel cycle options:

- In the once-through fuel cycle, the spent fuel is considered as waste material and is kept in storage until it is sent for disposal in a geological repository. While this option is presently advocated by Canada, Spain, Sweden, Finland and the United States, some other countries such as Germany are developing it as an alternative. This option does not consider the residual energy resources of the spent fuel and implies the disposal not only of all long-lived transuranium isotopes (TRU), fission products (FP), but also of plutonium.

- In the thermal LWR cycle the spent fuel is reprocessed and the remaining uranium and generated plutonium are separated from the FP. The FP are stored in liquid form for a number of years and then vitrified to be stored for several decades in engineered storage facilities. Ultimately the vitrified HLW and the TRU waste will have to be disposed of. This option is followed by Belgium, France, Germany, Japan, Switzerland, and the United Kingdom. Most of these countries already recycle plutonium and uranium in thermal reactors.
- In the FBR cycle, spent fuel from both the highly enriched core and the surrounding blanket region is reprocessed and the resulting uranium-plutonium product can be recycled for use in a FBR. Recycling of these fuel types has been shown to be feasible on an industrial prototype scale. The expected growth of the fast breeder option did not materialise as expected, mainly because of economic reasons. This option has mainly been developed in France, Japan, the United Kingdom, and the former Soviet Union.

Figure 2.1. The nuclear fuel cycle

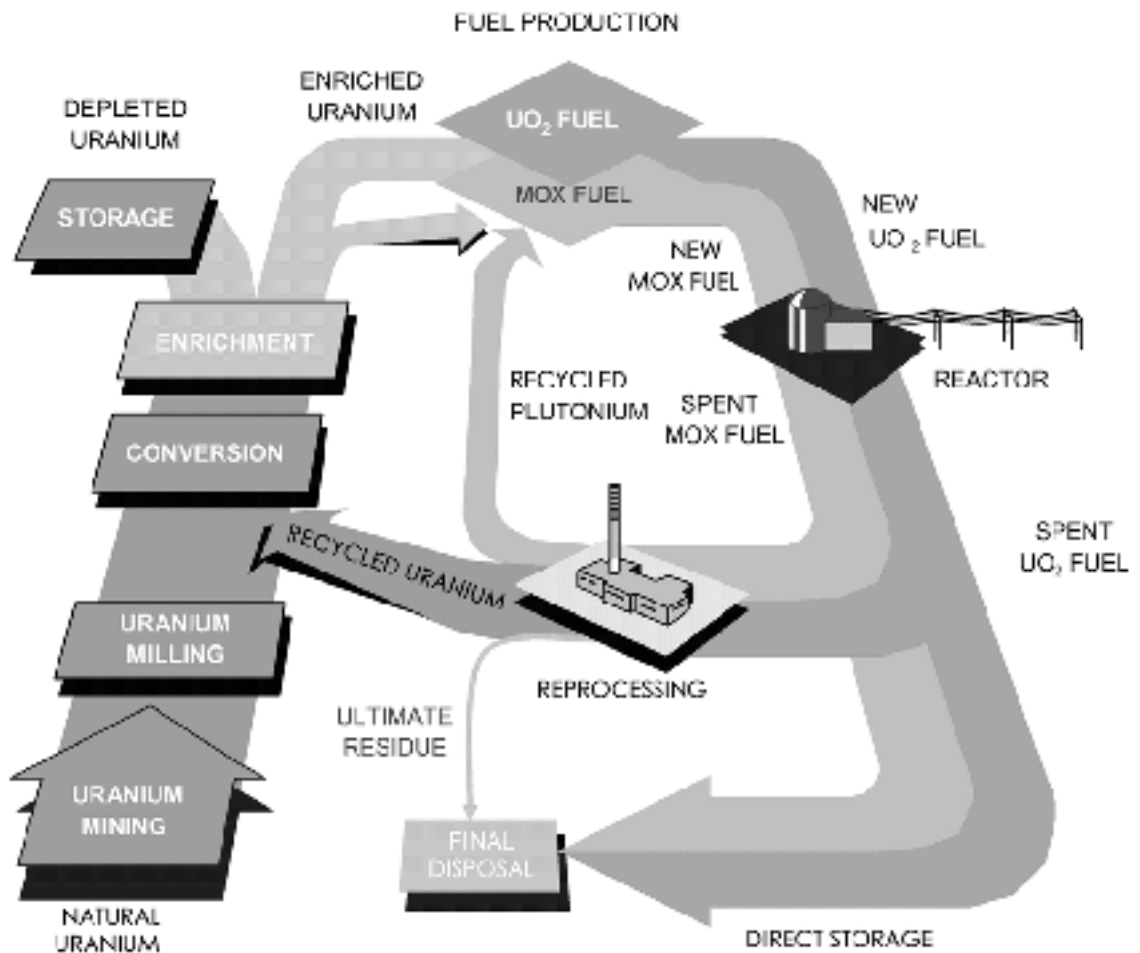

A combination of both LWR and FBR fuel cycles can provide an effective use of depleted and recycled uranium and plutonium resulting from reprocessing, should there be a sufficient rise in uranium prices in the future.

In both the thermal and fast breeder reactor cycles, facilities for the storage of separated plutonium have to be installed if an imbalance occurs between the reprocessing plutonium output and the fuel fabrication requirements for both types of reactors.

Plutonium stored over a relatively long period of time generates the decay product, americium, a strong gamma emitter, which interferes with the normal fuel fabrication procedures. Americium can be removed – at an economic cost – by a purification process.

Transport of plutonium in either solid or solution form from the reprocessing plant to the fuel fabrication plant, not generally co-located, requires careful consideration.

The choice of a specific fuel cycle option depends on a variety of different and sometimes interrelated factors. The economics of nuclear electricity production, the availability and price of uranium on the world market, the availability of other energy sources, safety factors, environmental considerations, as well as policies and political issues, all play a role in the final choice.

Until about 2015, uranium requirements, spent fuel production, reprocessing-recycling capacity, enrichment capacity, and fuel fabrication capacity can be reliably predicted on the basis of the present operating and scheduled nuclear power capacity. Beyond that date it becomes difficult to forecast with any precision the evolution of the nuclear market. Even the projected rate of LWR growth in that later period is very uncertain.

Nuclear power reactor fuel can be uranium metal, uranium oxide or uranium-plutonium oxide called MOX.

The production of U metal (natural or slightly enriched) continues at a level of about 460 tHM per year in 2002. This fuel is used in gas-cooled Magnox reactors in the United Kingdom. When these reactors close down at the end of their lifetime, this type of fuel fabrication will be phased out.

Uranium oxide fuels serve the main reactor programmes. Production has reached industrial capacities of 10 500 tHM per year for LWR fuel and 2 750 tHM per year for CANDU fuel in the OECD countries. The annual UO₂ fuel requirements are about 6 600 tHM. Recycling of plutonium in power reactors has become a new industrial venture since the MOX production facilities for fast reactor fuel have almost entirely been closed or reconverted for production of thermal MOX fuel. The production capacity of MOX fuel for breeder reactors has been reduced since there is little likelihood for a significant expansion of this reactor type before the end of the XXIst century. Japan is producing 5 tHM of fuel per year.

This report primarily considers uranium oxide fuel for LWR reactors (Figure 2.2) but also discusses the growing option of MOX recycling in thermal reactors. FBRs and gas cooled reactors (GCR) are taken into account, but at the present time their overall significance has decreased in the global nuclear picture compared with the past expectation.

Figure 2.2. View of a typical PWR fuel assembly
(Source: COGEMA – France)



2. Status of the various fuel cycle segments

In this Section the various segments of the fuel cycle are briefly described with emphasis on the present state of development and new ventures.

2.1 Uranium mining and milling

Uranium occurs in most rocks in concentrations of 2 to 4 parts per million and in the oceans at an average concentration of 1.3 parts per billion. Concentration of the metal as low as 0.1% have been mined. The most recent mine brought into production was Cameco's McArthur River, which has an average grade of 14.3%.

The major uranium ore mineral is uraninite or pitchblende. Reasonably Assured Resources plus Estimated Additional Resources – category 1, to US\$ 80/kgU, 1 January 2001, (from OECD/NEA and the IAEA, *Uranium 2001: Resources, Production and Demand*) amount to 3 107 000 tU. Australia, the Former Soviet Union, and Canada account for 65% of the world reserves as shown in Figure 2.3 [1]. Over half of the uranium production is from mines in Australia and Canada with total world production in 2002 amounting to 36 097 tU. Distribution by company is shown on Figure 2.4.

Figure 2.5 shows a fairly flat level of production since 1997 with a slight dip in 1999 as Cameco's Key Lake open pit mine was completed and the McArthur River underground mine was brought into production in 2000. There was minimal mine development with the exception of McArthur River, McLean Lake, and Beverly because of the low price of uranium. Uranium mine production was consolidated in the 1990s.

Figure 2.3. World uranium reserves

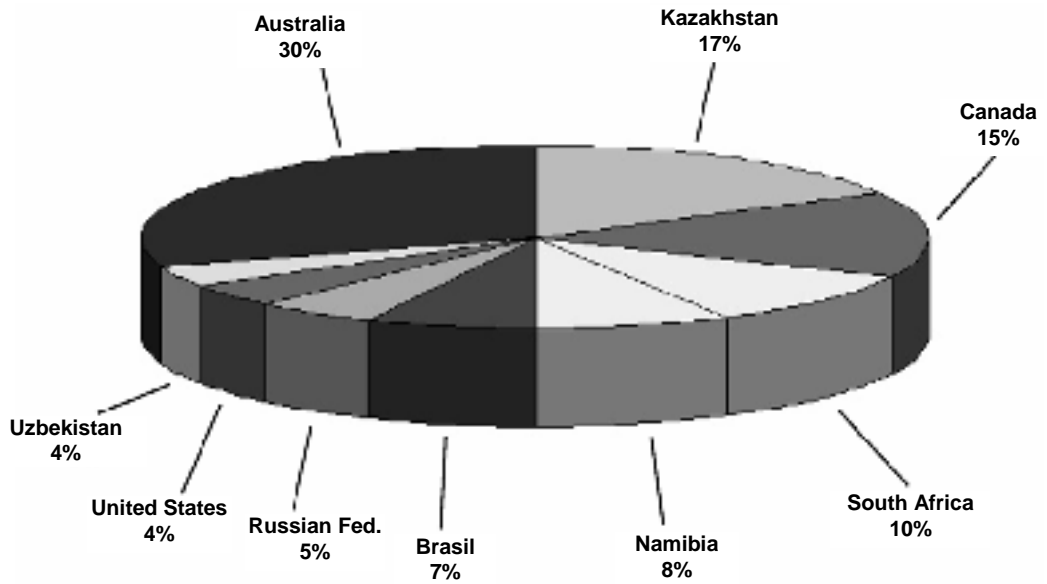

Figure 2.4. World uranium production – Distribution by company (1998)

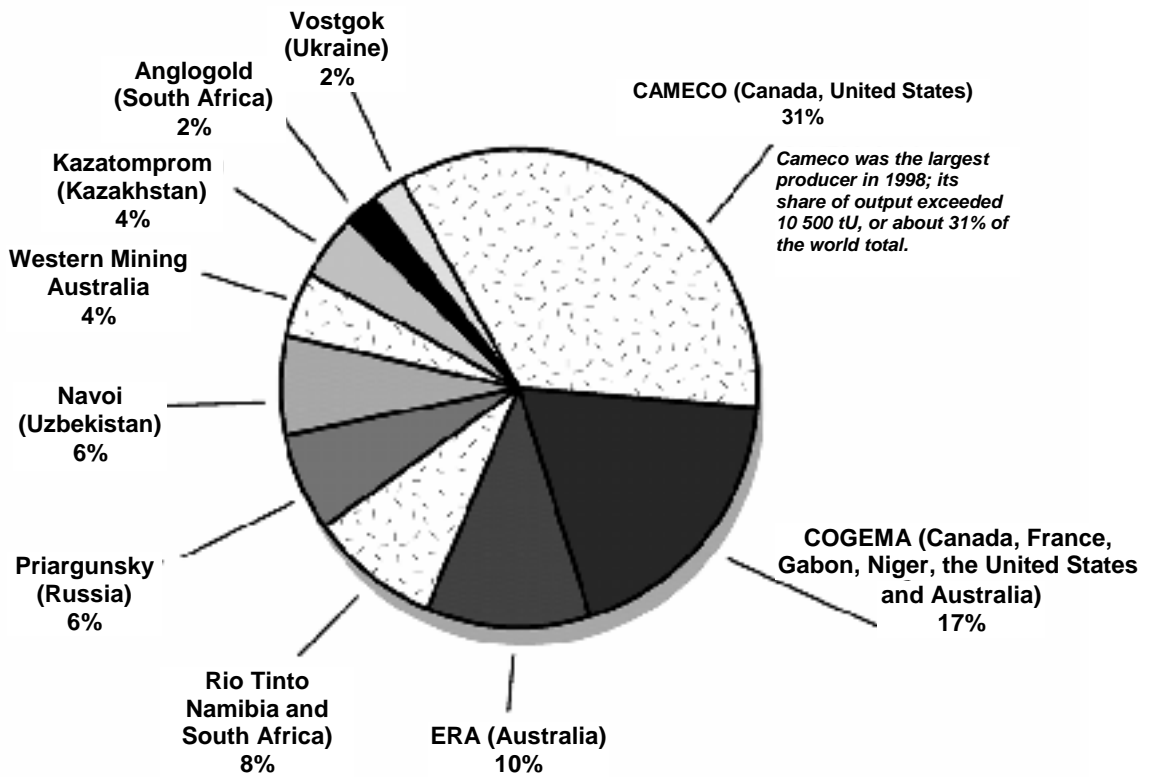
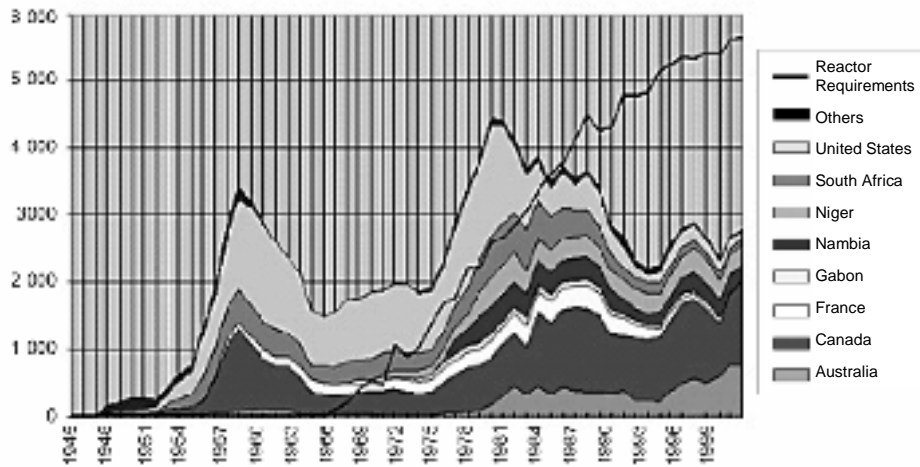

Figure 2.5. Western world production of uranium



There were eight major mining companies producing 80% of the world's production in 2002.

The major western world producing mines in 2002 are listed in Table 2.1 [2] below.

Table 2.1. World uranium production by company
(Source: Canadian Minerals Yearbook)

Mine	Country	Main owner	Type	Production (tU)	% of world
McArthur River/Key Lake/Rabbit Lake	Canada	Cameco	U'ground	7 199	19.9
Ranger	Australia	ERA	Open pit	3 804	10.5
Olympic Dam	Australia	Western Mining Co.	By-product/U'ground	2 451	6.8
McLean Lake	Canada	COGEMA	Open pit	2 345	6.5
Rossing	Namibia	Rio Tinto	Open pit	2 333	6.5
Akouta	Niger	COGEMA/Onarem	U'ground	2 010	5.6
Cluff Lake	Canada	COGEMA	Open pit/U'ground	1 620	4.5
Arlit	Niger	COGEMA/Onarem	Open pit	1 065	3.0
Vaal Reefs	South Africa	Anglogold/Nufcor	By-product/U'ground	824	2.3
Beverly	Australia	Heathgate	ISL	633	1.8
TOP ten total				24 284	67.3

Key Lake was completed in 1999 and McLean Lake (COGEMA) commenced open pit production in Canada with a capacity of 2 300 tU/y. McArthur River (Cameco) in Canada and Beverly in Australia commenced production in 2000 with a capacity of 8 200 and 900 tU/y respectively.

The mining methods used in 2002 were as follows [2]:

- open pit: 27%;
- underground: 45%;
- *in situ* leaching (ISL): 19%;
- by-product: 9%.

Open pit and underground mining use conventional mining techniques that have been adapted to protect the worker from the sources of radiation exposure. The open pit mines in Saskatchewan are up to 2% grade with ore production of up to 600 t/d and mining rate of 10 000 t/d. This compares to the Rossing Mine in Namibia that has a daily ore production of 30 000 t/d with a grade of about 0.05%. The Ranger Mine has about 8 000 t/d ore production at 0.3%. The underground mines outside of Canada are about 0.05% grade using high productivity long hole open stoping. The Cluff Lake Mine uses cut and fill with grades less than 1%. The Rabbit Lake Mine with grades around 2% uses a long hole stoping method with remote control scoop trams and drilling done from drill drifts in waste rock. This mine produced about 600 t/d in 1999. The McArthur River mine has an average grade of about 15%. A raise bore located in a waste rock drift is used to ream ore out in vertical panels producing approximately 150 t/d. The ore is handled with remote control scoop trams. This mine processes the ore underground to a slurry which is pumped to surface. This is an example of using the International Commission on Radiological Protection (ICRP) principle discussed in Section 5-1 to safely mine a high grade uranium ore body.

Open pit and underground mining use a radiometric measuring device to determine the grade of the material mined. The ore grade material is then processed. A typical process flow sheet for the extraction of uranium is shown in Figure 2.6. This process entails crushing and grinding of the ore followed by chemical leaching with acid or alkaline solutions. The acid leaching process is more widely used, usually using sulphuric acid because of its relatively low cost and more acceptable environmental impact as compared with other acids. The alkaline leach process is used for ores that would require excessive amounts of acid. An advantage with using alkaline carbonate leach process is that it is rather selective for uranium, thus leaving much of the radium out of solution.

Figure 2.6. Uranium extraction from ores

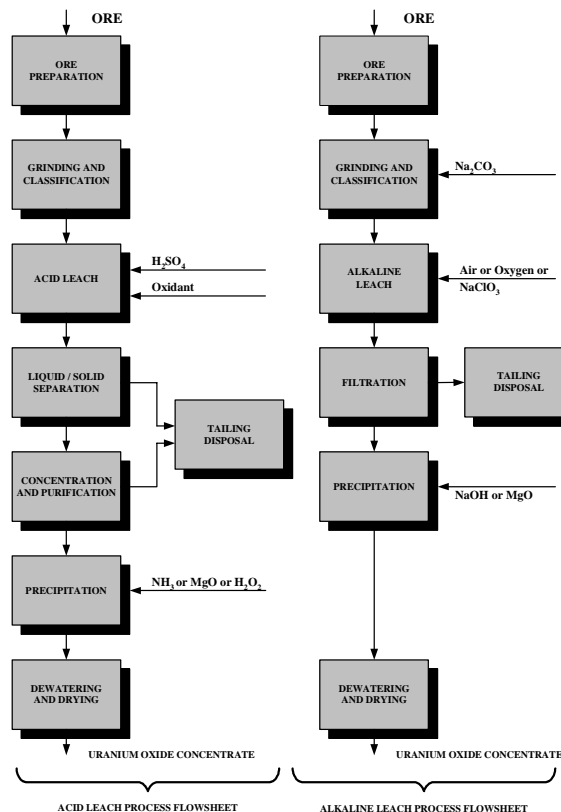

2.1.1 Sulphuric leach

The process entails crushing and grinding the ore, and then leaching with sulphuric acid and an oxidiser such as hydrogen peroxide. The resultant slurry is filtered and clarified, then transferred to an ion exchange unit operation that produces a uranium-bearing solution. The uranium is precipitated from the solution in the form of one of the diuranates, which is dried to produce a uranium oxide concentrate (U_3O_8) and further purified in a refining facility.

2.1.2 Alkali carbonate leach

This process entails crushing and grinding the ore, then leaching with sodium carbonate solution and an oxidising agent such as sodium chlorate, heating and putting under pressure to dissolve the uranium. The leach liquor is separated from the solids by filtration, and the uranium is precipitated with an alkali, usually magnesia or caustic soda, as a sodium or magnesium diuranate dried to produce a uranium oxide concentrate (U_3O_8), which is further purified in a refining facility.

The term “yellow cake” has been used in a generic fashion to describe the family of uranium precipitates, the so called diuranates, and to describe impure uranium oxide. In fact, the term “yellow cake” should only be applied to ammonium diuranate (ADU).

In situ mining leaves the ore in the ground. The uranium is leached from the ore in place. The conditions have to be conducive to this method. The ore zone must be relatively flat and porous. The waste above and below must be impermeable and below the water table. A series of production wells are drilled around the ore zone to be recovered with a set of injection wells inside. The leaching medium is pumped down the injection wells and recovered by the production wells. The leaching in calcium-type deposits such as limestone or gypsum requires alkaline leaching. Otherwise, acid leaching is used. Recoveries are usually complete in 6 to 10 months with 80% recovery. The pregnant solution goes through an ion exchange system or solvent extraction process to recover the uranium.

The waste products from mining are basically the same as other mines, waste rock, tailings and contaminated water, with precautions taken to deal with radioactivity. This topic will be discussed in Section 5-1. The barren waste rock handling standards are the same as at other mines. The mineralised waste rock piles that are not economical have to meet the stringent mining standards to deal with containment and run-off. This usually means that they are lined. The uranium mill tailings are more stringently handled because of the radioactivity. They are disposed of in specially designed tailings facilities that are approved by the assigned government agencies. The most recent tailings facilities are sub-aqueous deposition in mined-out pits if the geotechnical characteristics are appropriate. The contaminated water is treated at the facility to meet government-specified standards before release. Radium is generally the most critical radionuclide. It is removed from water by co-precipitation with barium.

2.2 Uranium refining and conversion

The end product from the previous stage of the fuel cycle is known as uranium ore concentrate (UOC), sometimes called “yellow cake” in recognition of the bright yellow colour of some, though not all, types of UOC. It consists of impure U_3O_8 or ADU, $(NH_4)_2U_2O_7$. Refining, or purification, processes are required to bring the UOC to a nuclear grade purity before it is converted through a series of chemical forms (UO_3 , UO_2 , UF_4) to UF_6 or uranium metal. Figure 2.7 shows a typical flow sheet of the processing sequence.

Figure 2.7. Uranium refining and conversion to hexafluoride

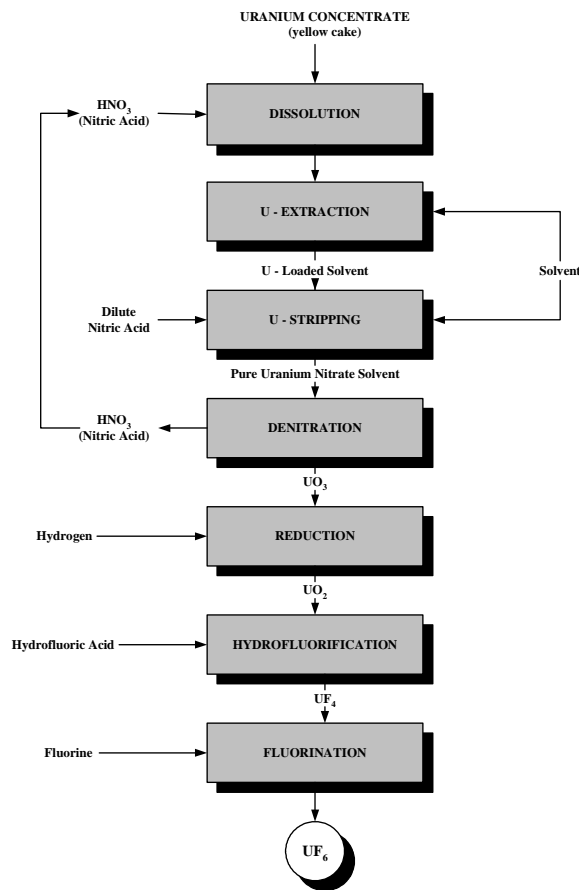

The uranium refining and conversion capacity in the OECD countries amounts to about 48 500 tU [3] per year while current UF_6 (hex) conversion requirements are approximately 34 000 tU per year. However, actual reactor needs usually exceeds requirements, with the difference being provided from stocks and other secondary sources. Demand has generally fallen steadily since the mid 90s, approximately 51 000 tU per year in 1994 [4]. Plants for both these stages are situated primarily in Canada, the United States, France, and the United Kingdom. The bulk is converted from UOC to hex for subsequent enrichment, with a small percentage (about 10% in total) remaining for production of oxide fuel for light water or heavy water moderated reactors (HWR) or metal fuel for graphite moderated or material testing reactors.

In the United Kingdom and in France, the use of UOC (from around 1950) replaced the original processes, based on extraction of uranium from pitchblende uranium ore with nitric and sulphuric acids, followed by precipitation with peroxide, solvent extraction in ether, re-dissolution in an aqueous phase and treatment with ammonia to precipitate ADU [5,6]. By the early 1950s, relatively high grade UOC had started to replace pitchblende as the feedstock and in the mid 1950s, the potentially hazardous ether purification stage was replaced by use of the less volatile, and less flammable, solvent tributyl phosphate (TBP), which continues to this day.

For most of the 1950s, production of UF_4 , UO_3 and UO_2 intermediates was carried out in small-scale batch converters [7]. Then in stages from 1958 to 1960, a major new production process, employing fluidised bed techniques for these stages, as well as a totally new plants for the upstream

dissolution and purification stages, were built in the United Kingdom (at Springfields) and in France (at Malvési) and brought into operation [6,7,8]. Though subject to many improvements of a safety and technical nature, and considerable increases to original capacity at all stages, these plants are still in operation today, with the exception of the UO₂ and UF₄ production stages at Springfields. The stages are now described.

The UOC received by the refinery is treated with hot nitric acid (90°C) that dissolves the uranium and the wide range of soluble impurities, leaving insoluble material – basically sand – to be filtered. The filtered solution is fed to a solvent liquid/liquid extraction operation in mixer settlers in the United Kingdom, pulsed purification columns in France, where it is contacted counter-currently with the TBP extracting agent in a solution of kerosene in the United Kingdom or dodecane in France. Precise conditions of acidity and concentration ensure the transfer of uranium to the organic phase and the retention of impurities in the aqueous phase. An adjustment of aqueous phase acidity, in a separate extractor unit, then allows the purified uranium to be re-extracted as an aqueous solution of uranyl nitrate that is concentrated by evaporation to a solution density of about 400 to 1 000 grams per litre (600 to 800g/l in France).

This solution is dried, then calcined at about 300°C in United Kingdom, 500°C in France, to pure UO₃ in a fluidised bed or batch pot contactor. A further alternative is to neutralise the concentrated uranyl nitrate hexahydrate (UNH) solution with gaseous ammonia, then calcine to UO₃. Reduction to UO₂ with hydrogen then takes place at about 500°C according to the reaction:

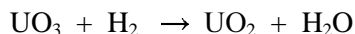

Some reactors use the UO₂ directly, for example, CANDU.

The next step in the uranium processing is conversion to uranium tetrafluoride by reaction with anhydrous hydrogen fluoride HF at about 450°C, thus:

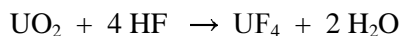

From about 1960 until the late 1970s, these two stages were carried out in fluidised beds. Then initially for commercial and operational reasons, the fluidised beds started to be augmented by large scale rotary kilns [8]. By the mid 1980s, all the fluidised beds for UO₂ and UF₄ production had been replaced by kilns [6] and it is noted that the use of kilns, instead of fluidised beds, together with the associated considerable reduction in amount of ancillary plant, confers significant benefits in safety. These are addressed in more detail in Section 5-2. Some converters carry this process out by use of a UO₂/H₂O/HF slurry.

The solid UF₄ powder is then converted to gaseous UF₆ (Hex) by reaction with fluorine at about 500°C according to the reaction:

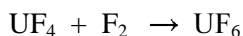

Off-gas purification steps, including fluorine removal, are necessary to ensure environmental protection. The hex product is condensed at about -10°C and placed into cylinders that are shipped to enrichment facilities. In the United Kingdom, this conversion is carried out in a fluidised bed of inert calcium fluoride, in France with gaseous fluorine in a flame reactor that does not contain any inert bed. This and all other current stages of the UOC to hex process are described in [8]. These technologies (fluidised bed and flame reactor), using chlorine trifluoride as the fluorinating agent, replaced the earlier batch method initially on a development scale [9], then in full-scale production units starting in 1962 in France at Pierrelatte and in 1968 in the United Kingdom, and continuing until the present time [6,10,11].

In some other countries, a dry, as opposed to the above wet, process is used for hex production. The UOC is reacted with hydrogen to produce uranium dioxide that is converted to uranium tetrafluoride with anhydrous HF, both stages in fluidised beds. Fluorine is used to produce crude UF₆, and the purification stage is carried out by distillation.

The first stage of the production of uranium metal (described in more detail subsequently) is a chemical process involving the following reaction:

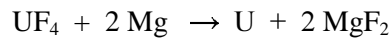

This reaction is carried out in electric batch furnaces at a temperature of about 650°C, though temperature during reaction rises to around 1 000°C (typically 1 500°C in France). Magnesium, as the reductant, replaced calcium [6] in 1957 in the United Kingdom.

The United Kingdom operator, BNFL, has announced in 2001 [12] that it will cease to produce hex after early 2006 and it has already stopped marketing hex. This is in recognition of the fact that many of the plants described above feed both metal fuel and hex manufacturing. After the closure of the United Kingdom metal fuel (Magnox) power reactors, it will be uneconomical to continue to run these plants. The Canadian operator, Cameco, will buy the United Kingdom's unsold hex conversion production.

The transformation of UO₂ into UF₄ with HF and the conversion to hex using fluorine involve the use of corrosive substances on a large scale. Fluorine also acts as a strong oxidising agent. The toxicity of these usual chemical substances is often of more concern than the radiological aspects of the uranium. This raises a number of safety issues that are addressed, together with radiological protection, in Section 5-2. The use of flammable reagents in industrial quantities is controlled to minimise the likelihood of fire and explosion that could cause an uncontrolled release of relatively large quantities of uranium.

2.3 *Enrichment*

Natural uranium consists of about 0.7% of the fissile isotope ²³⁵U and most of the remaining 99.3% is the non-fissile isotope ²³⁸U. Enriched uranium is used in the fuel for nuclear reactors. Most nuclear power reactors are light water moderated that use uranium fuel enriched up to 3 to 5% in the fissile isotope ²³⁵U. In order to obtain uranium of this grade, it is necessary to increase, or enrich, the level of the fissile isotope ²³⁵U in natural uranium. Therefore, enrichment is the process by which the concentration of ²³⁵U is increased from its naturally occurring level to the desired one needed for nuclear fuel production.

There are several methods by which uranium enrichment can be achieved. However, on an industrial scale, two processes have been proved to be reliable, safe, and relatively economical: the gaseous diffusion (GD) process and the gas centrifuge (GC) process. Both use gaseous uranium hexafluoride, UF₆, as feed material. In the GD process, UF₆ gas is forced through membranes that incrementally separate the isotope ²³⁵U from the isotope ²³⁸U. In the GC process, centrifugal acceleration separates the lighter isotope ²³⁵U from the heavier isotope ²³⁸U in high-speed centrifuges. For both enrichment methods, the UF₆ gas passes through cascades of enrichment unit steps to reach the desired concentration level of the fissile isotope ²³⁵U.

Presently, other uranium enrichment methods are being investigated. Such methods include the use of lasers to separate uranium isotopes. Two laser processes have been considered for uranium enrichment: the atomic vapour process and the molecular process. The atomic separation method is

often designated as Atomic Vapour Laser Isotope Separation, AVLIS (its French correspondent is SILVA), and it uses uranium metal as feed material. In the United States, the funding for AVLIS research was suspended in mid 1999. The molecular separation method, or Separation of Isotopes by Laser Excitation (SILEX), uses a laser beam to selectively excite one isotopic form of a molecular compound of uranium. The SILEX method uses uranium hexafluoride as feed material. At the present time, the most active SILEX development programme is located in Australia.

After the enrichment process, the remaining fissile uranium in the tail end product varies between 0.2 and 0.3% in ^{235}U with the balance being ^{238}U . The concentration of ^{235}U in the tail end product is determined by optimisation of technical and economical factors.

The Separative Work Unit (SWU) is a measure of the uranium throughput of an enrichment plant and of the separation work to be carried out in order to enrich uranium. The separation work varies according to the concentration of ^{235}U in feed, product and tails. For example, for the production of one kilogram of uranium enriched at 3.5% in the isotope ^{235}U , 6 to 8 kg of natural uranium at 0.7% of ^{235}U are required. This operation needs between around 5.5 and 4.5 SWU and will also produce a uranium tail with a concentration between 0.2 to 0.3% in ^{235}U .

The world annual capacity of uranium enrichment facilities (as for May 2003) amounts to 53 505 MSWU (i.e. 53 505 SWU). Of this total, 30.4 MSWU are based on the GD process and the rest on the centrifuge process. The annual enrichment requirements for the OECD countries amount to around 35 MSWU as for 2000, which show the extent of overcapacity existing in the world. This overcapacity is enhanced by the availability of high-enriched uranium (HEU) resulting from the surplus defence inventories, which can be down blended to natural or depleted uranium (DU) to reach proper enrichment.

The large uranium enrichment plants based on the GD process are situated in France and the United States. Large centrifuge enrichment plants are situated in Holland, Germany, the United Kingdom, Japan and Russia. Smaller plants based on both types of processes are operating in several other countries.

In the United States, the USEC gaseous diffusion plants (GDP) have a combined production capacity of 18.7 MSWU per year. The plant located at Paducah, Kentucky, has a production capacity of 11.3 MSWU per year. The plant at Portsmouth, Ohio, can produce 7.4 MSWU per year; however, it has been closed since May 2001.

The GD EURODIF "Georges Besse" plant at Tricastin in France has been ready for its full capacity of 10.8 MSWU per year in 1982 [13,14]. It has reached a cumulated production of 150 MSWU by the first quarter of 2003. The plant operates all year long on a 24-hour basis. In 2003, AREVA made the decision of building a new enrichment (Georges Besse II) plant based on centrifuge technology to be located at Pierrelatte.

The URENCO centrifuge plants in Germany, the Netherlands, and the United Kingdom have a combined capacity of 5.85 MSWU per year. The development of these plants has been steady because of their economic advantage compared to GD, and the technical maturity of the centrifuge technology. URENCO is planning to submit two applications to the US Nuclear Regulatory Commission (NRC) for the construction of centrifuge plants in the United States in the calendar year 2004. URENCO announced in 2001 that the beginning of operations for this plant is scheduled for end of 2006 or beginning of 2007.

In Asia, both Japan and China have modest production capabilities for enriched uranium.

During the year 2003, Japan's production totalled 1.05 MSWU. The Japanese pilot plant at Ningyo-Toge started in 1979 was shut down in 1990 after having produced 51 t of enriched uranium. At Ningyo-Toge, a demonstration plant with an overall capacity of 0.2 MSWU per year, which had started operation in 1988, was also shut down in February 2001 after having produced about 200 000 SWU. This demonstration plant has experienced the enrichment of reprocessed uranium during its operation. Additionally, JNC developed the technology of Carbon Fibre Reinforced Plastic instead of metal for the rotor. A commercial plant at Rokkasho is now operational with a capacity of 1.05 MSWU per year. In 2010 the developed centrifuges are scheduled to be installed for the plant extension to the final capacity of 1.5 MSWU per year.

In 2002, China produced 0.9 MSWU at the Hanzhong centrifuge plant.

The combined Russian production of enrichment is 15 MSWU per year. This production is divided into Minatom's four centrifuge plants: Novouralsk with an annual production capacity of 7 MSWU, Siberian Chemical Combine with 4 MSWU, Krasnoyarsk-45 with 3 MSWU, and Angarsk with 1 MSWU.

A specific area of expansion for GC-based enrichment capacity exists in its use for the recycling of reprocessed uranium. Enrichment of this uranium by both diffusion and centrifuge techniques has been demonstrated to be a safe and reliable procedure. No major radiological incidents have been reported. GC has probably a decisive advantage because of the much smaller equipment for the same capacity, meaning easier management of contaminated parts.

New enrichment processes are at the pilot and/or demonstration stage; these include the laser enrichment process [15,16,17] and the chemical enrichment process.

In Japan, the ASAHI chemical enrichment plant observed higher efficiencies in pilot-plant operation than on bench scale. This plant was terminated in 1992. The economy of the process seems to have prevented any further development [18].

The occurrence of increasing trace amounts of ^{232}U , ^{233}U , ^{234}U and ^{236}U in recycled uranium has an influence on its neutronic behaviour and its radiological impact. Additional enrichment will increase the ^{236}U isotope concentration which has a neutron capture cross section high enough to marginally decrease the overall reactivity of recycled uranium. The concentration of ^{236}U may build up from nearly 0 to 0.42% for fuel irradiated at 33.2 GWd/tHM up to 0.64% at 50.5 GWd/tHM [19].

The radiological impact concern results from the increased ^{234}U activity and from the presence of ^{232}U which is a parent isotope of the 4 n natural series producing the gamma emitters ^{228}Th and ^{208}Tl . After a number of years this radionuclide will build up in recycled UF_6 .

Results based on the industrial-scale operations with reprocessed UF_6 have been reported by URENCO [20] and in Japan by JNC Ningyo-toge Demonstration plant which produced 5.3 t enriched uranium from reprocessed UF_6 . Some neptunium but very little plutonium and FP were found in the UF_6 feed from reprocessed fuel. The centrifuge enrichment process is very well-suited to handle these relatively low contamination levels due to the small in-process inventory of the centrifugation cascade and the relatively maintenance-free operation.

Procedures to deal with the presence of ^{99}Tc might be required when recycled uranium is introduced into an enrichment plant [20].

2.4 Fuel manufacture

2.4.1 Uranium oxide fuel (enriched uranium)

Enriched uranium is produced and usually stored as UF_6 . In order to produce UO_2 fuel, it is necessary to reconvert the UF_6 into UO_2 . Three processes have been used to carry this out (see Figure 2.8):

Figure 2.8. UF_6 to UO_2 conversion processes

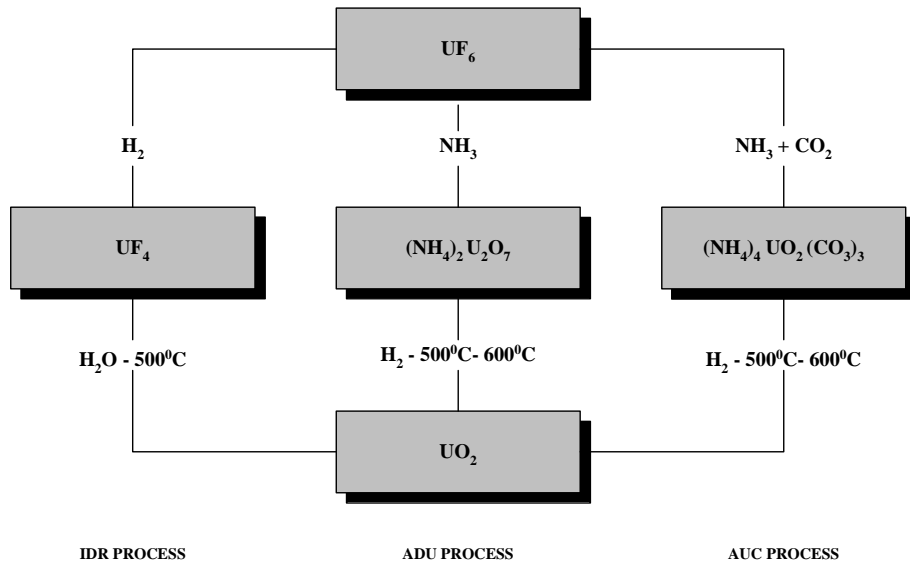

Reduction of UF_6 to UF_4 with hydrogen followed by hydrolysis of UF_4 with steam according to the reactions that occur in a single integrated kiln - the Integrated Dry Route (IDR):

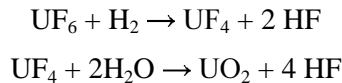

Direct conversion of UF_6 into UO_2F_2 followed by precipitation with ammonia to form ADU and reduction with H_2 to UO_2 :

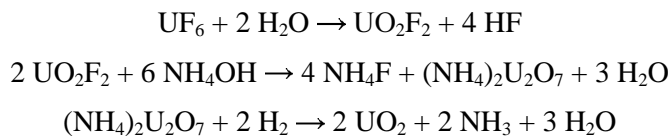

The AUC process by which UF_6 is transformed into Ammonium Uranyl Carbonate (AUC) by treatment with CO_2 and NH_3 in water:

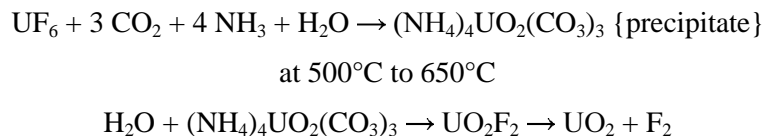

A great deal of industrial experience has been gained with each of these processes in the United States, the United Kingdom, France, Germany and Japan. The main hazard is chemical and is associated with the use of corrosive, flammable and toxic chemicals which also are contaminated with enriched uranium.

Protection from releases of radioactive compounds is ensured by dynamic barriers such as ventilation hoods and engineered safety systems.

No major incidents with radiological consequences have been reported, but some incidents (mainly dealing with the transfer of UF_6 to the plant) have been reported at the conversion plants, in France and Germany.

The production process for UO_2 pellets involving compaction and sintering has been improved by use of automatic presses, incorporation of shielding and a higher degree of containment than hitherto.

Each of the fuel fabrication steps produces “clean reject oxides” (CRO) and “dirty reject oxides” (DRO) which have to be recycled or considered as waste materials.

With the entry of reprocessed uranium into the fuel fabrication plant some complications may arise due to the presence of ^{232}U , ^{234}U and ^{236}U which are more radioactive than the natural isotopes (^{235}U and ^{238}U). The presence of this wide spectrum of uranium isotopes in facilities which were not originally designed for that purpose requires that the operations be adequately assessed.

2.4.2 *Fast reactor fuel*

Fast neutron reactors are referred to as “breeders”, since these reactors would generate more plutonium than they would burn [21]. Extensive pilot-scale experience has been gained in industrial facilities for the production of $(\text{U-Pu})\text{O}_2$ with 15 to 30% Pu content. The difference between LWR and FBR fuel lies in the higher Pu concentration of the latter and in the type of cladding (stainless steel or ferritic steel instead of zirconium alloy) which is used. The criticality problems involved in producing industrial quantities of $(\text{U-Pu})\text{O}_2$ (20%) fuel have been solved.

In the United Kingdom, the BNFL Sellafield plant had an annual capacity of 5 tHM MOX-FBR for use in the Dounreay PFR. In Germany, Alkem’s Hanau plant had a yearly capacity of 10 tHM MOX-FBR for KNK II and SNR 300. In Belgium, the BN plant had an annual output of 8 tHM MOX-FBR and produced fuel for KNK II and SNR 300. In France, CEAs Cadarache plant (operated later by COGEMA) has produced 390 tHM of MOX since 1964, particularly for the prototype Phénix reactor (4 tHM/y) and the power plant Superphénix (20 tHM/y). In Japan, a new MOX fuel fabrication plant at Tokai mura with a 5 tHM/y MOX-FBR output has been operated in order to provide the necessary fuel for the experimental fast reactor JOYO and the prototype FBR MONJU.

Uranium-plutonium carbides and nitrides have been proposed and studied as alternatives to $(\text{U-Pu})\text{O}_2$, but this option has not been developed beyond the bench scale. U/Pu carbide fuel has been manufactured and irradiated in prototype fast reactors. Nitride fuels have only been fabricated in pellet form. The pyrophoricity of carbide and nitride fuels further compounds the complexities in fabricating, transportation and reprocessing of MOX bearing fuels.

FBR fuel fabrication facilities have at least two physical barriers separating plutonium from the environment: the first physical barrier is the glove box and the second is the containment building. In addition, a dynamic barrier (ventilation) protects the workers, and high efficiency particulate filters (HEPA) confine releases within the facilities. Fire, explosions, criticalities, and external events are the potential causes, leading to loss of containment, against which adequate safety preventive measures are taken. These measures are also valid for LWR mixed-oxide fuel fabrication considered below.

2.4.3 Mixed oxide fuel (MOX)

Historically, the development of uranium and plutonium MOX fuel is mostly due to the technology of fast neutron reactors. At present, the development of “fast” reactor systems is no longer an issue and the fabrication of MOX fuel for light water reactors falls within the scope of two strategies: recycling of the plutonium derived from irradiated fuels and reduction of the American and Russian stocks of excess military plutonium. An overview of the role of plutonium recycled in LWRs can be found in [22].

Though reconversion of MOX fuel fabrication plants from FBR fuel to LWR fuel has taken place recently, the experience acquired with the fabrication of MOX fuel goes back to more than 30 years. A historical record of this fabrication, for both FBR and LWR, is provided in [21]. MOX fuel has been used in LWRs for more than 30 years in Europe (since 1972 in Germany, 1984 in Switzerland, and 1987 in France). In 2000, 35 European reactors were using MOX fuel (including 20 in France), and this number continues to increase. In Japan, electric utilities intend to gradually increase the number of LWRs using MOX fuel to a total of from 16 to 18 by the year 2010 [23].

By late 2000, over 2 700 MOX assemblies had been irradiated in European pressurised water reactors (PWRs) and boiling water reactors (BWRs). Half of the 1 400 assemblies loaded in French power plants have completed three irradiation cycles, and a few of them have been irradiated 4 or 5 cycles for experimental purposes. In Belgium and Germany, several dozen assemblies have been irradiated 4 cycles, with a burn-up of 46 GWd/tHM. For information on MOX fuel performance and future prospects for development, refer to [24,25,26]. As for end of 2003, there are three production plants for the fabrication of MOX fuels for LWRs in service world-wide, at Marcoule (MELOX), Dessel and Sellafield SMP).

In France, the MELOX plant in Marcoule, with an authorised production capacity of 115 t oxide HM of fuel per year (around 105 tHM), was commissioned in 1994 and has attained its nominal capacity since 1997. Mainly intended to supply fuel for French power plants (EDF), it began to fabricate fuel for Japanese power utilities in 1999. The increase of capacity up to 145 tHM/y has been authorised in September 2003.

The COGEMA (originally CEA) plant in Cadarache, whose production capacity per year is approximately 40 tHM, was commissioned in 1962. Initially intended for the fabrication of MOX fuel for fast neutron reactors, it mainly fabricated MOX fuel for German LWR power plants since 1995. A production line for Phénix and Superphénix fuel could still be used. At the request of the French nuclear safety authorities, this plant has ceased industrial production in July 2003 after having produced 390 tHM. Industrial production of LWR MOX fuel has been transferred to MELOX plant. The fabrication of a pilot batch of MOX elements from US military plutonium in excess before the decommissioning of the installation has been authorised in 2004. It is intended to qualify the fabrication process and the product of the future DFFF plant (see below), by use of these elements in a US reactor.

In Belgium, the Belgonucléaire plant in Dessel was commissioned in 1973 and was initially intended for the fabrication of MOX fuel for both FBRs and LWRs. In 1984, it was reconverted to supply MOX fuel for LWRs according to the MIMAS process, and its production capacity was increased to 35 tHM per year.

The MOX fuel fabrication process implemented in these three plants, shown in Figure 2.9, is the MIMAS (MICronized MASTer blend) process. It consists of producing a first blend of uranium oxide and plutonium oxide with a PuO₂ content of approximately 30%, referred to as the primary blend, and then grinding it so as to micronise the uranium oxide and plutonium oxide grains. This finely ground blend is then diluted with UO₂ and subsequently homogenised to obtain a homogeneous blend with the PuO₂ content specified by the clients. Crushing the UO₂ and PuO₂ powders (micronisation) is an important stage of the process to ensure that a solid phase (U-Pu)O₂ develops during the sintering of the MOX pellets. The formation of this solid phase is essential to guarantee the solubility of the oxide in nitric acid during reprocessing.

Figure 2.9. MIMAS MOX fuel fabrication process

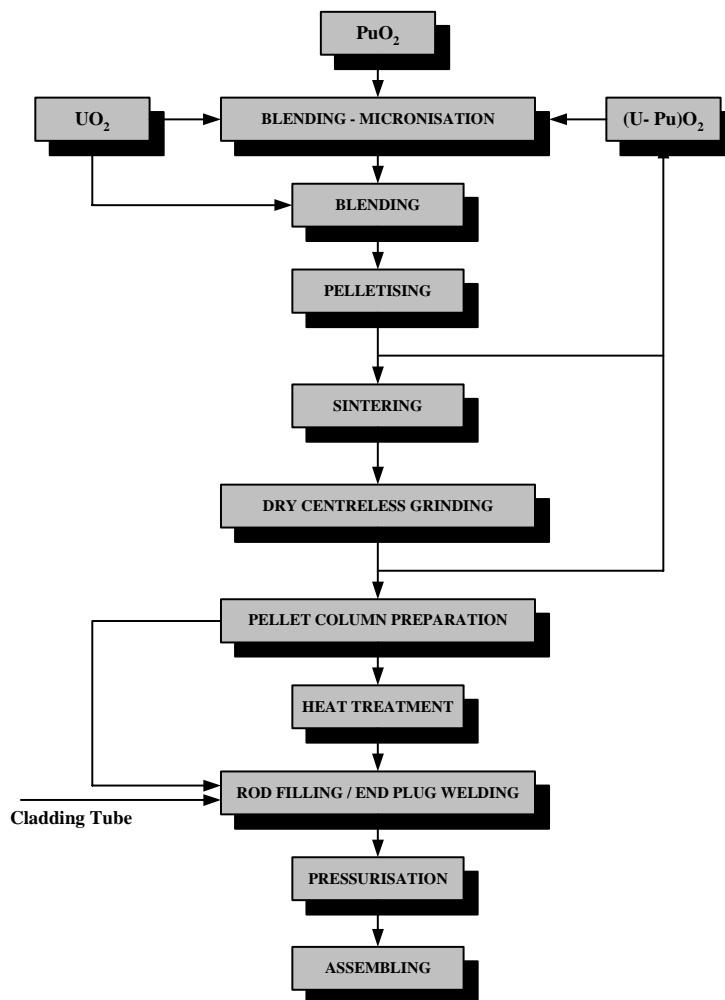

The blend thus obtained is transformed into green pellets (by pressing) that meet the specific characteristics of the type of fuel fabricated. The transformation of the green pellets into ceramic is

obtained by means of a high-temperature thermal treatment in sintering furnaces. After the sintering stage, the pellets are ground to obtain the dimensional characteristics required and are subject to a large number of checks to guarantee their compliance with the quality-related characteristics specified for the product.

In the various stages of this process, the products generated may fail to meet the quality specifications sought for the product and are thus classified as rejects. The most part of these rejects is recycled in the process as “chamotte”. The chamotte recycling operation consists of breaking the pellets, and then finely crushing them to obtain a product that can be directly recycled to produce the primary blend or the final blend. As in conventional ceramics craftsmanship or its industry, the addition of a significant proportion of reground ceramic in the base products makes it possible to obtain a final product of high quality.

In the United Kingdom, BNFL in collaboration with AEA Technology developed a process in its Sellafield pilot facility, “MDF” (MOX Demonstration Facility), to obtain the direct blending of PuO_2 and UO_2 powders with the specified PuO_2 content. This process, called SBR (Short Binderless Route), consists of producing the MOX powder by blending premeasured quantities of PuO_2 and UO_2 powders and a small quantity of lubricant in a high-energy attritor mill containing steel balls. The homogenised powder thus obtained is transformed into granules in a spheroidiser and then transformed into green pellets by pressing. After the pressing operation, the remaining stages of the process are similar to those applied by other MOX fuel fabricators.

This BNFL MDF facility, with a production capacity of 8 tHM/y, was commissioned in 1994 and discontinued in 1999. The same process was selected for the SMP (Sellafield MOX Plant), with a production capacity of 128 tHM. SMP was completed in 1997 and licensed in 2002.

Two stages have been added to the MDF process (after the blending, before the spheroidiser):

- the first of these consists of homogenising the equivalent of three batches;
- the second consists of reconstituting a unit batch with an admixture of lubricant in a second grinding mill.

In Japan, JNFL plans to build on the same site as the Rokkasho Reprocessing Plant a MOX plant with a maximum production capacity of 130 tHM per year; it is scheduled for commissioning around 2009. According to the nuclear policy of the Japanese government that disallows surplus plutonium, the plutonium recovered at the Rokkasho Reprocessing Plant will be recycled to LWR. The MIMAS process has been selected after evaluation since it accepts the microwave denitrated 50/50 MOX powder from the reprocessing plant.

The milling of UO_2 and PuO_2 powders, often called micronisation, is an important part of the mechanical mixing process to ensure that a solid solution of U-PuO₂ is produced during sintering of the MOX pellets. As told before, the formation of a solid solution of U-PuO₂ is important to ensure solubility of the pelleted oxide in nitric acid for reprocessing.

The fabrication of MOX fuels results in the generation of plutonium-contaminated waste materials and scrap fuel residues in the form of CROs and DROs. The recycle of these scrap fuel residues to maximise production plant efficiency and minimise the costs of both fuel production and waste management is an important part of fuel production plant management.

An alternative route to the production of MOX fuel is based on co-precipitation and is known as the AUPuC (Ammonium Uranyl Plutonyl Carbonate) process developed by ALKEM (Germany) [27]. This is similar to the AUC method but the uranium and plutonium are precipitated simultaneously as $(\text{NH}_4)_4(\text{U-Pu})\text{O}_2(\text{CO}_3)$, in aqueous solution. The precipitate is a completely homogeneous solid solution which, after calcination at 600°C , produces a free-flowing powder of $(\text{U-Pu})\text{O}_2$, product which is soluble in boiling HNO_3 . However, this process requires the transportation of plutonium in aqueous solution on the public field if the MOX plant is not situated near the reprocessing plant. The advantage of the method lies in the absence of dust throughout the production process but its drawback lies in the criticality limitation inherent to any aqueous plutonium processing method. A third process for the production of $(\text{U-Pu})\text{O}_2$ is still closer to reprocessing technology. A co-conversion of uranium-plutonium nitrate has been developed by PNC (Japan) [28] and is based on dehydration and denitration of product solutions from the reprocessing plant by microwave heating.

The flow sheet of the process is shown in Figure 2.10 and constitutes a mid-way between the full dry-powder process of Belgonucléaire-COGEMA and the process aqueous precipitate of AUPuC. The process requires a very efficient off-gas treatment unit but lends itself very well to automation and operation in shielded glove boxes. Since crushing and milling operations of UO_2/PuO_2 are incorporated in the process, dust containment is a major concern.

Figure 2.10. Flow sheet of PNC (now JNC) co-conversion process

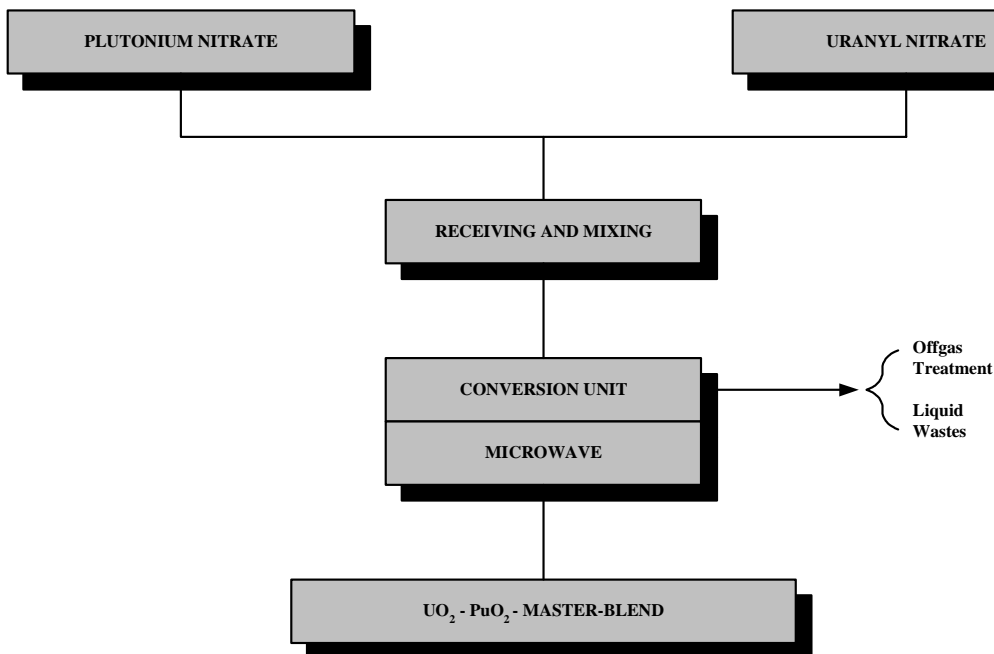

The corresponding FBR fuel fabrication process has been developed by JNC (Japan). It mixes uranium oxide with the powder product of the co-conversion of 50/50 uranium-plutonium nitrate. It is implemented in the Plutonium Conversion Development Facility to feed the Plutonium Fuel Production Facility, both in Tokai mura. The flow sheet of the process is shown in Figure 2.11 below.

Figure 2.11. MOX fuel fabrication process at PFFP (Japan)

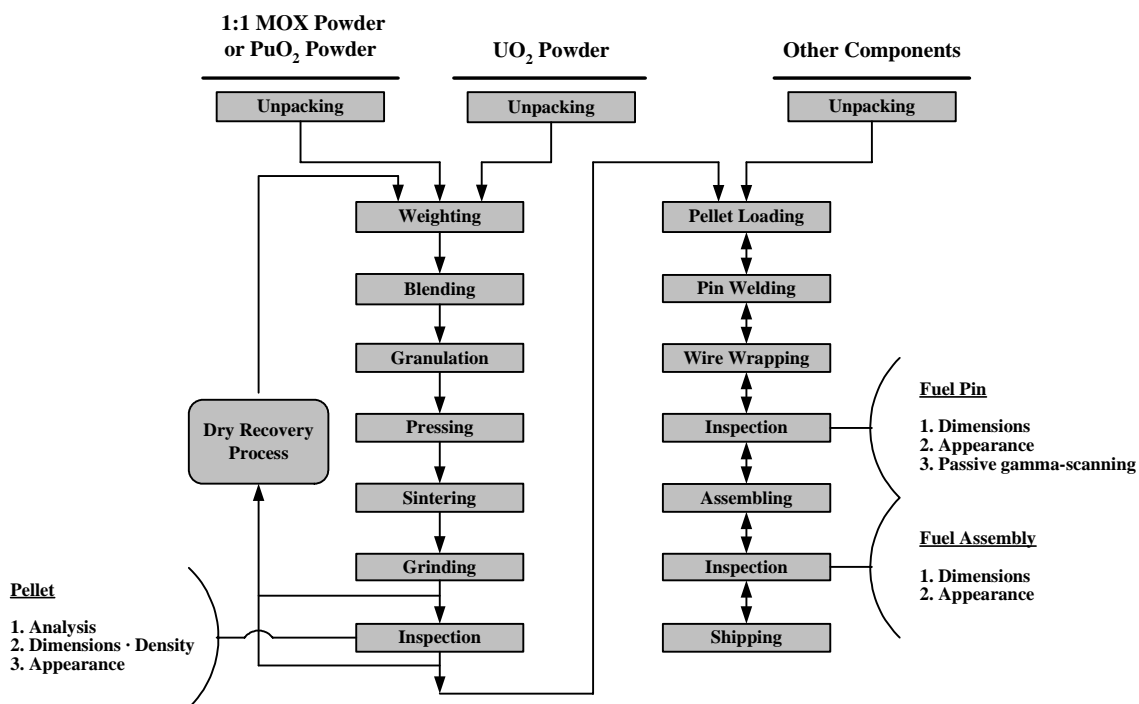

In Russia, a GRANAT process similar to the ALKEM one has been developed. It also uses co-precipitation, but involves specific additives for improving the size and shape of the generated particles. It has been used in the PAKET experimental facility located in the MAYAK complex to produce some experimental fuel for the FBR BN 600. It was envisaged for the large MOX plant project A300 that was never commissioned.

As far as the reduction of the American and Russian stocks of excess military plutonium is concerned, the US Department of Energy (DOE) has entrusted the design, construction, and operation of an MOX fuel fabrication facility (MFFF) on its Savannah River site to DCS, a consortium made up of Duke Engineering & Services, COGEMA, and Stone & Webster. The fabrication process selected is based on the technology developed by COGEMA and Belgonucléaire (MIMAS process), for which the most recent developments have been carried out in the MELOX plant in Marcoule (France). The MFFF construction authorisation request was filed in 2000.

As far as Russia is concerned, France and Germany have been engaged in a joint programme offering the same solution to this country for many years now.

2.4.4 Metal fuel

Metallic uranium was the first type of fuel developed and is still used in high-flux research reactors and gas-cooled reactors. Uranium dioxide (UO_2) is converted to UF_4 and this compound is mixed with magnesium or calcium shavings and pressed into pellets. By heating the pellets at more than $500^\circ C$, the reaction is:

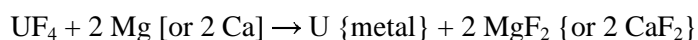

U metal is produced that is separated from the MgF_2 or CaF_2 slag.

Uranium metal alloyed with aluminium is used in high-flux material test reactors.

2.5 *Spent fuel storage*

The nuclear electricity production in LWRs needs about 27 tHM/GW_e per year, at typically 33 000 MWd/tHM as spent fuel. This fuel is initially stored at the reactor site in pools. The fuel is later transported to a reprocessing plant equipped with large storage pools (La Hague, Sellafield) or away from reactor (AFR) storage pools waiting further reprocessing (delayed reprocessing) or disposal site.

The cumulative spent fuel arising in OECD countries amounted to approximately 200 000 tHM by 2001 and is expected to grow to approximately 370 000 tHM by the year 2020 [29]. Non-OECD countries bring approximately 20% more, but this proportion is continuously increasing. The available storage capacity on the reactor sites and away from the reactor sites in OECD countries amounts to approximately 210 000 tHM in 2001 and is expected to increase to 250 000 tHM in the year 2005.

The total installed pool storage capacity away from the reactor sites is about 35 000 tHM of which 10 000 tHM capacity is situated at the reprocessing sites of Sellafield and 18 000 at La Hague. Two other large facilities, independent of the reprocessing plants, are situated in Sweden (CLAB 5 000 tHM, commissioning of extension to 8 000 tHM scheduled for 2004) and Finland (Olkiluoto-Loviisa, 1 270 tHM). The residual capacity of less than 1 000 tHM is dispersed throughout the world.

The storage of spent fuel requires:

- shielding to handle the fuel;
- cooling to maintain fuel at a safe temperature;
- criticality safety control;
- means and facilities for control of water chemistry;
- means and facilities for decontamination.

Dry storage capacity has been constructed for oxide at Gorleben (3 800 tHM) and Ahaus (3 960 tHM) in Germany, and at Wylfa in the United Kingdom for Magnox fuel.

In Switzerland, operation of the central interim storage facility at Würenlingen started in 2001. This facility has 200 cask positions for dry storage of spent fuel or high-level radioactive waste (HLW) from reprocessing. The capacity is sufficient to store the spent fuel and HLW arising from 40 years of operation of all Swiss nuclear power plants. At the end of 2003, there were 12 casks (9 with spent fuel, 3 with HLW) in storage at this facility.

The Independent Interim Spent Fuel Storage installation (5 000-6 000 tHM) dry storage is planned to operate in 2010 in Japan.

The Monitored Retrievable Storage (MRS) facility of 15 000 tHM that was to be built in the United States has been abandoned.

2.5.1 *Pool storage*

Pool storage capacity (~120 000 tHM) at reactor sites is by far the most important but its discussion is not within the scope of this report. It is, however, important to draw attention to an extensive study carried out by the IAEA and NEA on the storage of LWR spent fuel in pools [30]. This survey concluded that no degradation of stored LWR fuel had been observed over a time period of up to 23 years. In the meantime years have been added to this good safety record of pool storage. The document recommends that spent fuel examination should be ongoing if its storage in pools continues for several decades. In order to cope with an increasing inventory of spent fuel, utilities in the United States and other countries have undertaken actions to increase the in-reactor capacity by reracking and the addition of a second row of racks [31]. Reracking involves the change of the rack configuration by which smaller distances between individual assemblies are obtained. This practice requires the addition of more neutron absorbing material, adequate cooling, and design against earthquakes. Improved neutron absorbers based on boron carbide containing materials have been developed and successfully installed.

Experimentally, rod consolidation has been investigated and involved mechanically removing the fuel rods from the fuel assembly hardware, and placement into a canister. Effective consolidation also requires the compaction and disposal of the grid spacers, guide tubes and end fittings.

2.5.2 *Dry storage*

Dry storage has been developed but is not yet used to the extent of wet storage, and it is probable that for safety, technical, and economic reasons, commercial fuel will always need a cooling period in wet storage. However with the increasing storage period of the spent fuel, dry storage may have advantages over wet storage. From a technical and design point of view, the transport and dry storage of spent fuel impose very similar technical requirements on flasks.

The first step of long-term use of what is the extension of the on-site storage of spent fuel consists in dry flasks unloaded from the reactor storage pool after some years of cooling [31,32].

From a safety point of view, adequately designed and operated dry storage has the advantage that the probability of a loss-of-cooling accident is extremely small.

Several transport flasks (CASTOR, CONSTAR, TN 24) are designed to withstand external events and have been tested for use between on-reactor-site storage and AFRs (Gorleben) [33]; they can also be used in Monitored Retrievable Sites [34].

The problems related with heat transfer, criticality and long-term integrity of the flask have already been thoroughly assessed in the framework of direct disposal concepts for spent fuel. The disposal containers are different since they are usually designed to withstand very high hydrostatic and lithological pressures, and the materials used in container construction have to be compatible with the geochemical characteristics of the host rock. Important studies have been conducted in Sweden [35], Germany [36] and the United States [37].

2.6 *Spent fuel reprocessing*

Reprocessing plants, both those currently in service and those at the planning stage, all use or intend to use the PUREX process [38]. This is a solvent extraction process in which the sheared fuel is

dissolved in nitric acid, then the constituents are extracted using tributylphosphate (TBP) diluted in kerosene or dodecane counter-currently circulating. Figure 2.12 shows a simplified representation of this process. An industrial scale plant handles 4 to 6 tHM per day and carries out the following operations:

- head-end operations that involve receipt of fuel from storage, shearing or decladding, dissolution, clarification and fissile material accountability;
- separation of uranium and plutonium from other actinides and from the fission products by liquid-liquid extraction;
- purification of the uranium and plutonium;
- concentration of the uranium and in some cases also of the plutonium;
- conversion of the uranium and plutonium to oxide and storage;
- concentration and storage of the FP;
- waste processing (encapsulation and storage).

Figure 2.12. Reprocessing operations

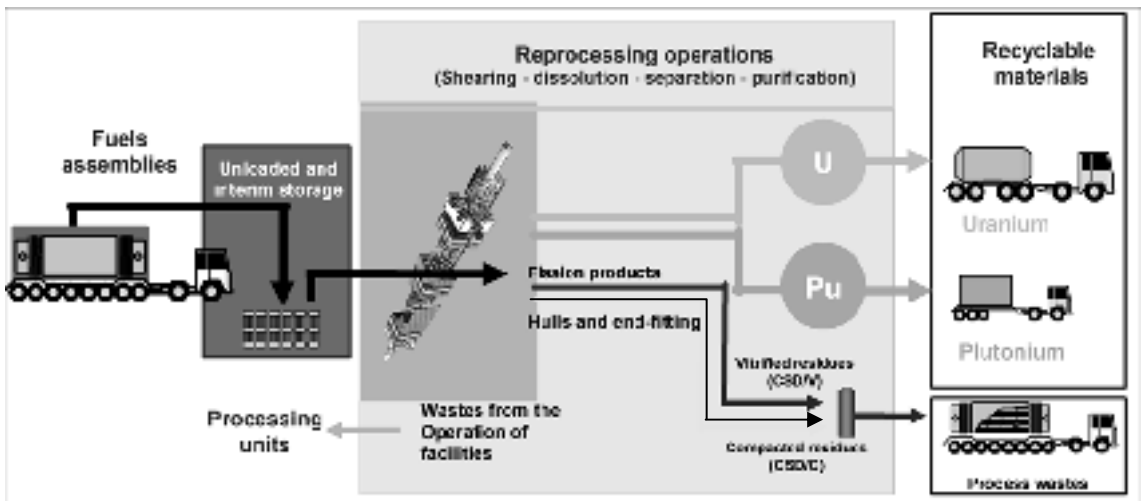

Industrial experience of reprocessing fuel from gas cooled or light water reactors has been acquired over the last 40 years in France, the United Kingdom and Japan [39,40,41]. These countries have established reprocessing-recycling as their fuel management route.

In France, the first reprocessing plant was UP1, built at Marcoule and designed for handling metallic fuels, which operated from 1958 to 1997. It is currently being dismantled, having reprocessed over 18 000 tHM of fuel. The La Hague site includes the UP2-800 and UP3-A plants and has reprocessed 6 000 tHM of metallic fuel between 1966 and 1987 and over 18 300 tHM of oxide fuel between 1976 and 2002. Each of these plants is equipped with a shearing and dissolution unit, with a new type of continuous rotary dissolver made from zirconium, and three extraction cycles (uranium-plutonium, plutonium, and uranium) using pulsed columns technology.

A HLLW vitrification workshop called R7, which is part of UP2-800, was commissioned in 1989. A second vitrification workshop called T7, part of the UP3-A plant, was commissioned in 1992.

A pilot reprocessing plant built at Marcoule, called APM (Atelier Pilote Marcoule), commissioned in November 1962, has been created in order to validate at pilot scale the processes elaborated in laboratories for the reprocessing of spent fuel. The plant has been progressively modified and extended to follow the evolution of fuels and processes. The final evolution was the adjunction of the TOR facility, commissioned in 1987, with a capacity of 5 tHM/y [42]. This plant has been successively used for the processes of reprocessing natural uranium – gas – graphite fuel for the French reactors, then for LWR (including MOX) and FBR oxide fuels. Its operation has ceased in July 1997. Current decommissioning operations are the occasion of implementing innovative processes and technologies that will make it possible to optimise this life-stage of fuel cycle facilities. PIVER vitrification facility, quoted in the waste Sections of this document, was in fact part of the APM facility.

In the United Kingdom, irradiated Magnox fuel reprocessing has been carried out at Sellafield for over 50 years and has so far handled over 30 000 tHM. This figure is expected to reach some 50 000 tHM by the end of the Magnox programme.

To carry out this programme, a high capacity reprocessing facility was built in the early 1950s, and a second one commissioned in 1964. During the 1970s, this latter plant was refurbished and reinforced with the aim of keeping the Magnox power stations running beyond the start of this century.

Following the 1977 public inquiry, approval was given to build the THORP plant at Sellafield for oxide fuel reprocessing [43]. This plant started operating in 1994. The THORP plant has an estimated service life of about 25 years and a capacity of 1 200 tHM/y.

The flexible irradiated MOX fuel reprocessing plant at Dounreay had a capacity of 8 tHM/y for fuels of any isotopic enrichment. A total of 18 tHM has been reprocessed and 3 tonnes of plutonium extracted. The plant was designed to meet the forecast requirements for reprocessing fuel from the United Kingdom's FBR. The plant has also reprocessed non-standard fuel produced by foreign light water reactors. This facility complemented the Dounreay research reactor reprocessing plant, which has handled 1.7 tHM of HEU from over 10 000 elements during over 30 years. These plants were shut down permanently in 1992.

In Japan, TRP, the Tokai Reprocessing Plant, a pilot facility with a design capacity of 210 tHM per year, has been commissioned in 1977. By December 2003 it had reprocessed some 1 023 tHM of fuel from different reactor types. It is now used for experimental fuel reprocessing, with an authorised capacity of 40 tHM/y. In 1985, Japan decided to build an industrial nuclear fuel cycle complex at Rokkasho mura in northern Japan. This complex comprises an enrichment plant, a low-level radioactive waste disposal centre (mainly for waste from nuclear power stations), a storage facility for waste returned from France and the United Kingdom and a large industrial reprocessing unit with a capacity of 800 tHM per year, including a 3 000 tHM storage pond for spent fuels and a vitrification plant. The new reprocessing plant is based on French technology with partial inputs of Japanese, German, and British technologies, and is due to be commissioned in 2006. Japan also initiated a new programme to create a test facility for reprocessing FBR fuel using advanced technology.

In Germany, a pilot plant at Karlsruhe (WAK) operated for over 20 years and reprocessed about 200 tHM from different reactor types [44]. The plant was shut down in 1990. A research and development programme was carried out in this unit over several years with the aim of establishing new methods of reprocessing LWR fuels and waste [45].

The safety records of FBR reprocessing in Eurochemic, Dounreay (40 tHM), Tokai (0.1 tHM), La Hague (10 tHM) and Marcoule APM (17 tHM) plants have been good.

2.6.1 Head-end process

In the conventional “chop and leach” head-end process, the fuel elements from LWRs are mechanically sheared into small pieces. These are then collected in a basket that is located in a dissolver containing boiling nitric acid. The different components of the nuclear fuel (uranium, plutonium, actinides, and fission products) are dissolved, the hulls and in some cases the end pieces remaining in the basket. The solution, containing finely divided insoluble particles, is sent to a clarification unit that uses centrifuging or filtration to remove the solid particles. After clarification, the solution is analysed to determine its fissile material content (accountancy), then treated to adjust the valency of the plutonium prior to extraction. The Zircaloy or stainless steel hulls and end-pieces are washed to remove as much fissile material as possible.

The gases and vapours generated by the shearing-dissolution operation are processed to trap particles and iodine (mostly ^{129}I) before being released. In the French plants, a special device designed to improve iodine desorption by boiling the solution and send iodine to the trap is included downstream from the dissolver. Research and development work has been carried out in several countries aimed at removing ^{85}Kr , but has not matured to the industrial level. The Sellafield THORP plant removes most of the ^{14}C in the form of barium carbonate (BaCO_3).

2.6.1.1 Safety aspects of head-end operations

The mechanical cutting techniques have advanced substantially [46,47,48,49,50]. The fuel elements are introduced into the shearing unit vertically, as in the UP2-400 plant, or horizontally, as in the UP3-A, UP2-800, and THORP plants; this unit is equipped with either a horizontally moving blade (UP2-400, UP2-800 and UP3-A) or a vertically moving blade (THORP). The shears are designed for fully remote-controlled operation and maintenance. Equipment redundancy, specialised maintenance cells, and modular design of the electromechanical equipment help reduce shutdown time and the doses received by personnel.

The pyrophoricity of the Zircaloy powder requires special precautions because of the potential for fire or explosion. Proper design of the shear and the use of inert gas circulation where necessary combine with the inerting effect of UO_2 powder and the large size of Zircaloy powder particles to help prevent this type of explosion [50].

Dissolution of chopped spent fuel is not a risky operation if done slowly. However, criticality considerations play a significant role in the design and layout of the dissolver and in the choice of fuel batches. The use of highly enriched fuel increases criticality safety problems and either the actual burn-up of the dissolved fuel elements needs to be taken into account or neutron absorbers added so that safety is maintained in all circumstances.

Insoluble residues consist of very finely divided particles of platinum group metals that may contain plutonium oxides and various precipitated fission products. Their thermal output is very large, so special precautions have to be taken during clarification and the subsequent storage of the collected residues.

Improvements in the design and construction of dissolvers include the use of zirconium, mainly as a corrosion-resistant structural material, upgraded construction quality and the use of continuous dissolvers such as the French rotary basket dissolver [51,52]. These improvements are leading to an increase in the dissolvers' throughput and a reduction in the maintenance and servicing requirements. Accountancy poses special problems in the case of continuous operation, and appropriate checks are made to monitor for the build-up of deposits and the accumulation of material in the dissolver vessels and pipes.

2.6.1.2 Head-end equipment for MOX and FBR fuel reprocessing

See [53,54]. The first factor to be taken into account in designing the reprocessing equipment is the plutonium content of the irradiated fuel, which may exceed 1% for the conventional fuel from a light water reactor, 5% for MOX fuel in the same type of reactor and up to between 15 and 18% for MOX fuel in a FBR. On an industrial scale, MOX fuel is generally reprocessed by "diluting" the MOX fuel with conventional LWR UO₂ fuel. The higher plutonium concentration in MOX fuel calls for close attention to criticality control. Process control equipment able to detect incomplete dissolution has to be used in order to avoid accumulations of fissile oxide in the plant, especially for LWR MOX [55,56].

Reprocessing fuel from FBRs, especially after a short cooling time, requires specially designed and engineered facilities in order to cope with high heat release, but also very high plutonium content and the potential presence of sodium on and in the fuel pins. So far, shearing has been carried out pin by pin or in small bundles of pins housed in a container to guarantee criticality safety and avoid equipment overheating.

Although sodium may be removed by washing off before shearing, its residual presence may make it necessary to inert the inside of the shear in order to avoid sparks and any potential for explosion of hydrogen following contact with aqueous solutions or a moist atmosphere.

2.6.2 Solvent extraction

All the large reprocessing plants currently in operation use the PUREX process [38] or a close variant. This is a solvent extraction process that involves circulating an organic phase in counter-current to an aqueous phase. In general, the uranium and plutonium are separated from the fission products in the first stage. In subsequent stages, the uranium is separated from the plutonium and the two products are purified to the required level. Figure 2.13 shows a schematic representation of the PUREX process, without the technical details.

In the most common version of the PUREX process, the aqueous solution is a solution of nitric acid which is counter-currently contacted with a solution of TBP (tributyl phosphate) diluted to 30% in kerosene or dodecane. The uranium and plutonium are extracted by the TBP in the organic phase while the fission products and other residues stay in the aqueous phase. In a second contacting equipment, the uranium is separated from the plutonium by reduction using excess uranium (IV) stabilised by hydrazine added to the aqueous phase.

Figure 2.13. PUREX flow sheet

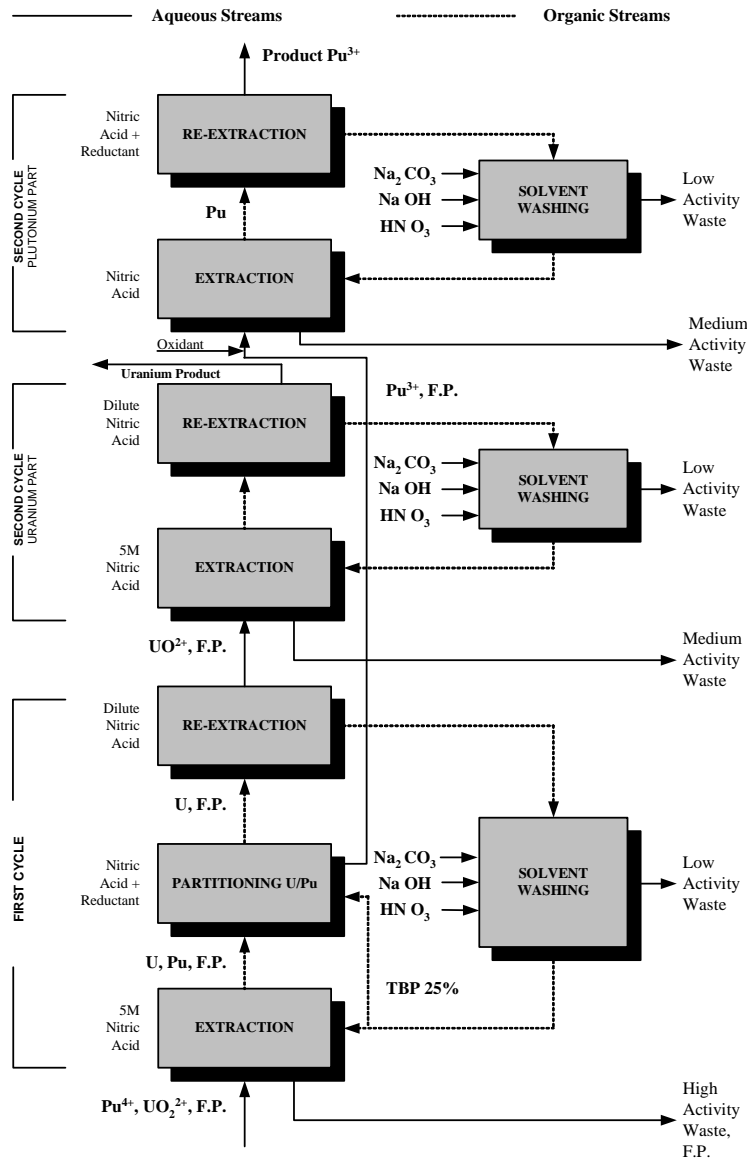

It should be noted that uranium (IV) is prepared from uranium (VI) by reduction, which can be carried out outside the hot facilities. Plutonium (III) is transferred to the aqueous phase to undergo purification while the mixture of uranium (IV) and uranium (VI) remains in the organic phase. The uranium is then re-extracted (stripped) from the TBP stream using diluted nitric acid. The solutions are concentrated by evaporation to between 300 and 1 000 g/l, then transferred to the conversion plant.

The evaporators used in some processes to concentrate the plutonium solutions are very sensitive to corrosion caused by the oxidation-reduction phenomena that occur on the surface of the equipment [presence of plutonium (VI)]. The welds are particularly vulnerable, and remote-controlled repair work has had to be carried out in Germany and other countries. Constructors now switch to more corrosion-resistant materials such as zirconium, tantalum, tantalum alloyed with 5% titanium, or steel with 25% chromium/20% nickel.

The use of evaporators working under reduced pressure and at a lower boiling point constitutes a very effective method to increase the equipment lifetime and to improve the overall safety of the distillation process.

The conversion of the plutonium and uranium nitrate solution to UO_2 , PuO_2 , or $\text{UO}_2\text{-PuO}_2$ by chemical processing and calcination completes the PUREX process.

Uranyl nitrate solution is concentrated by evaporation, and may then be calcined to give uranium trioxide (UO_3). The trioxide is then reduced to the dioxide UO_2 using hydrogen. The plutonium nitrate is concentrated by evaporation and is either kept in solution and sent to a conversion plant (for example as at La Hague in France or as it was the case for the Dounreay plant in the United Kingdom), or more usually it is converted to dioxide at the site of the reprocessing plant.

The conversion of plutonium nitrate to PuO_2 can be carried out by one of two chemical processes: oxalate precipitation followed by calcination to PuO_2 , or peroxide precipitation giving PuO_2 directly. Figure 2.14 illustrates the main steps of these two chemical processes.

Figure 2.14. Uranium and plutonium conversion to UO_2 , PuO_2 and $\text{UO}_2\text{-PuO}_2$ for MOX production

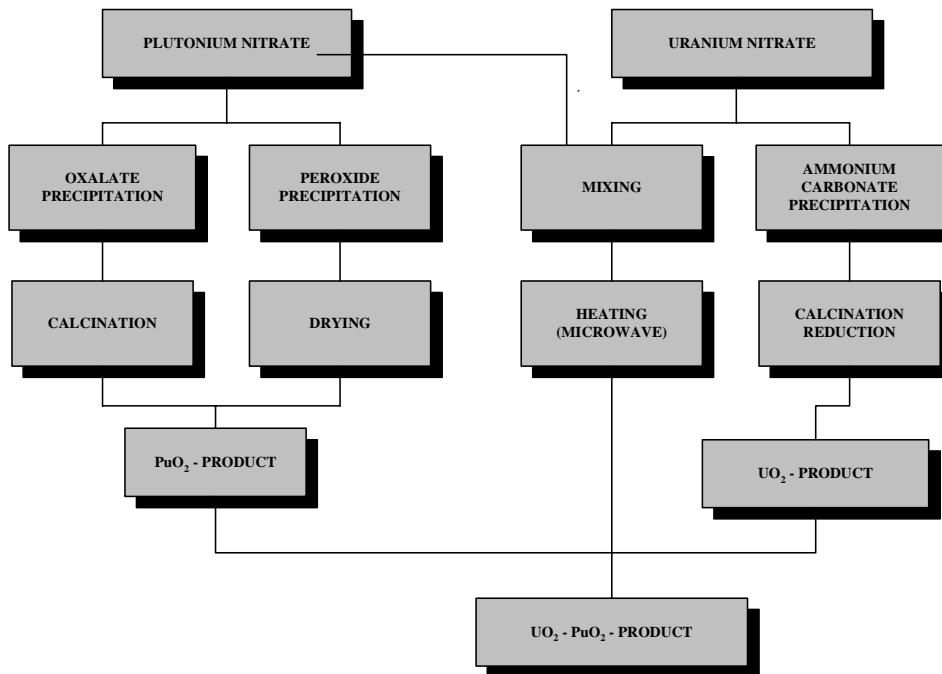

Precipitating the oxalate gives fine microscopic crystals of PuO_2 that can be used as a raw material for manufacturing fuel. Precipitating peroxide is better suited to other subsequent operations, such as plutonium metal production.

A large amount of experience in the production of MOX has been acquired in France (ATPu at Cadarache and MELOX at Marcoule), Belgium (Dessel), Germany (Hanau), Japan (Tokai mura), and in the United Kingdom (Sellafield). Generally, mechanical mixing of micronised powders is used, but some plants use the co-precipitation method instead.

The German AUPuC conversion process yields directly a master blend of $\text{UO}_2\text{-PuO}_2$, which is soluble in HNO_3 [57].

The process developed in Japan takes uranium-plutonium nitrate solution and calcines it to $\text{UO}_3\text{-PuO}_2$ by microwave heating. The resulting product is suitable for interim storage, and can be calcined under hydrogen atmosphere to yield $(\text{U-Pu})\text{O}_2$ suitable for fuel fabrication [58].

More detail on these processes can be found in Section 2-2.4.3 treating MOX fuel fabrication.

2.6.3 Plutonium storage

Plutonium may be stored for varying lengths of time at different stages in the fuel cycle before being sent to a fuel manufacturing plant where it is incorporated into fresh MOX fuel elements. Plutonium can be stored in different forms:

- as a nitrate at the tail-end of the reprocessing line;
- as an oxide or as a master-mix of $\text{UO}_2\text{-PuO}_2$ at the back end of the reprocessing plant or at the front end of the fuel fabrication plant;
- as an oxide in fresh MOX fuel, or in spent UOX or MOX fuel.

Storing plutonium in solution requires special precautions because the alpha radiolysis produces hydrogen, which has to be continuously removed by ventilation to avoid the build-up of an explosive mixture. Criticality imposes limitations for storing plutonium solution. This is generally dealt with by geometric control (for example slab, annular, harp tanks).

Plutonium oxide stored for a prolonged period emits increasing amounts of gamma radiation as ^{241}Pu is transformed to ^{241}Am . Plutonium storage facilities must cater for the neutron flux which results from spontaneous fission reactions and alpha-n emissions from the ^{238}Pu , ^{240}Pu , and ^{242}Pu isotopes [59]. The ^{241}Am content varies from 1.5 to 3% depending on the initial ^{241}Pu content and the decay time. Apart from the usual 5.64 MeV alpha rays, this large array of radionuclides emits a vast spectrum of low energy gamma radiation and X-rays.

The heat emission comes from ^{238}Pu (0.55 W/g leading to a thermal dissipation of 12.6 W/kg of plutonium with 2.3% of ^{238}Pu) and with time of the increase of ^{241}Am content. Thermal dissipation can exceed 30 W/kg of plutonium for plutonium from a highly irradiated MOX fuel after some years decay time. Plutonium storage facilities, whether in solid or liquid form, must also cater for this emission.

2.6.4 High-level liquid waste (HLLW) concentration and storage

HLLW from the initial extraction cycles of the PUREX process (about $5\text{ m}^3/\text{tHM}$) is normally concentrated by evaporation to between 250 and 500 l/tHM depending on its salt content. It is then stored for several years in cooled tanks placed in shielded cells (Figure 2.15). The storage period depends on the fuel characteristics, its cooling time, and the thermal dimensioning of the vitrification facility and of the vitrified waste storage facility. In a typical fuel cycle, reprocessing and vitrification are scheduled for between three and five years after fuel unloading.

The heat dissipated by the 35 kg of radionuclides contained in a tonne of irradiated heavy metal, 33 000 MWd/tHM, represents 10 kW/tHM one year after unloading from reactor and falls to 1 kW/tHM after 10 years.

Figure 2.15. Fission products solution tank in the R7 facility
(Source: COGEMA – France)



The HLLW tanks are equipped with multiple and redundant cooling coils so that the required cooling capacity is guaranteed at any time without interruption. A single tank can be used to store solutions containing several exabecquerels (10^{18} Bq) of fission products and actinides. Storing these aqueous solutions requires the use of very reliable and comprehensive safety measures. Radiolysis of the solutions producing hydrogen, sedimentation of precipitates, and the dissipation of heat are the main phenomena that occur in these tanks. The reliable safety measures referred to generally include venting, a system for treating the off-gases including a scrubber and filtration stages, adequate monitoring equipment for temperature, liquid level control, and leak detection and stirring (mechanical, by pulsation or sometimes by bubbling). All forms of bubbling of the solution tend to entrain droplets of waste thus increasing the load on the off-gas treatment system and one tries to avoid their use.

Storage facilities for HLLW are protected against external hazards by applying conservative design criteria that take account of the most severe recorded historical hazards (earthquakes, flooding, cyclones, etc.) and by providing them with protection systems that maintain their integrity in the case of fire or an accidental aircraft crash.

2.7 *Radioactive waste management*

After reprocessing, the non-volatile radionuclides (fission products and minor actinides) contained in the irradiated fuel are located as follows:

- for more than 99% in HLLW, stored in tanks awaiting solidification, by vitrification for instance;
- in stored HLL solid waste, for insoluble residues and hulls;
- in intermediate-level liquid waste from the reprocessing of effluent and organic waste;
- in stored medium-level solid waste for plutonium contaminated solid waste.

High-level and intermediate-level wastes are packaged in a safe way in view of their long-term management. There is a strong tendency to perform this on-line with the process, without the use of interim storages in bulk, whose safety is difficult to guarantee on the long-term.

Intermediate-level liquid waste is produced during reprocessing following purification of the solvent and in distillation operations. It is treated chemically by flocculation to eliminate most of the alpha and beta-gamma emitters. The aqueous liquids resulting from the flocculation of these effluents are released into the environment in the rivers or into the sea under the current authorisations after monitoring. The sludges are immobilised, for example by embedding in a matrix of cement or bitumen. These effluents can also be concentrated in evaporators and the concentrates sent for vitrification with the high-level solutions. The solid waste resulting from these treatments is disposed of in either surface or underground repositories, depending on the types of waste and the country, or stored safely in view of their long-term management.

The off-gas generated during reprocessing, which contain a number of radionuclides (^{85}Kr , ^{129}I , tritium, ^{14}C , and aerosols), are chemically purified or filtered by HEPA filters:

- most of the tritium and a fraction of the ^{14}C are discharged in the form of liquid waste;
- most of the ^{129}I is recovered in the gas scrubbing solution before being discharged to the sea, and a small fraction may be fixed to a solid impregnated with silver for long-term storage;
- aerosols are trapped by HEPA filters;
- ^{85}Kr is discharged at the stack of the reprocessing plant.

Research and development work on the retention of ^{85}Kr has been carried out on cold test units in Germany and Belgium and on a hot pilot in Japan, but no industrial-scale implementation has yet been established.

Among the high-level solid wastes, the insoluble residues extracted from the dissolution solutions are particularly significant because of their very high activity. They have to be stored for subsequent incorporation into vitrified waste.

The zirconium hulls can be embedded in cement and stored for a certain amount of time before their disposal in order to reduce the gas formation rate. Other packaging techniques for hulls have been studied (such as melting or high pressure compaction), and an industrial compaction facility was commissioned at the beginning of 2002 at the La Hague site.

The sludges resulting from the chemical treatment of residual effluents can be stored in tanks, recycled, or packaged in bitumen or concrete or vitrified. The choice of the packaging mode depends on the volume reduction rate of the waste and the strategy adopted for long-term management.

2.7.1 Solidification of high-level waste (HLW)

The method of solidifying HLW by vitrification has reached the industrial stage level for years. The French Atelier de Vitrification Marcoule (AVM), R7, and T7 facilities [60] and the German PAMELA facility [61] have so far vitrified the largest volume of HLW. In the United Kingdom, the Windscale Vitrification Plant (WVP), using the AVM process, was commissioned in 1990, while the Japanese Tokai Vitrification Plant (TVF) was commissioned in 1995 and the DWPF facility is operating in the United States at the Savannah River site. More vitrification facilities are planned in the United States (in particular at Hanford), and the Rokkasho mura plant in Japan will feature a vitrification unit using the same process as the TVF facility.

Vitrification consists of transforming HLLW into borosilicate glass by mixing glass-forming compounds (SiO_2 , B_2O_3 , Na_2O , Al_2O_3) with about 15% oxides of radioactive products, then heating the mixture to 1 100°C to achieve incorporation.

In France, the Marcoule AVM was commissioned in 1978. This installation served as a prototype for the R7 and T7 vitrification facilities built at the La Hague site. It has so far vitrified 1 140 m³ of HLLW, representing a total activity of 7×10^{18} Bq, and packaged the vitrified waste into 1 450 containers with a total weight of 500 tonnes of borosilicate glass.

Decontamination factors (DF) from 10^7 to 10^8 are obtained in the off-gas purification circuit and the lifetime of the melting vessel has been increased from the original 2 000 hours to nearly 6 000 hours. Repeated servicing and repair work carried out on mechanical equipment has however resulted in a dispersion of radioactive contamination in the facility, which has been refurbished.

The La Hague vitrification facility R7 came into service in June 1989 and had produced 4 800 glass containers (150 litres each) by the end of 2001. The T7 vitrification facility came into service in 1992 and had produced 3 500 glass canisters (also 150 litres each) by the end of 2001. The R7 and T7 facilities each have a rated capacity of over 800 tHM per year, so that they can handle the quantities stored before they came into service while still coping with current production. Each vitrification facility features three identical lines, each with a maximum calcination capacity of 60 litres per hour of processed solution and a vitrification capacity of 25 litres of glass per hour. The storage building is cooled by forced air circulation and can house 4 500 containers for each facility. Figure 2.16 shows a schematic representation of the AVM process and Figure 2.17 liquid glass pouring from the melting oven (during tests).

The PAMELA vitrification process developed by KfK and implemented by DWK at the Eurochemic reprocessing site at Mol in Belgium vitrifies liquid waste, mixing it with molten glass inside a ceramic overflow melting furnace heated by the Joule effect in the molten glass. The glass formula has been chosen to suit the specific composition of the HLLW. The capacity is 11 kg of glass per hour. This prototype, built between 1981 and 1984, has vitrified about 450 m³ of HLLW since commissioning and has produced 940 canisters of 60 litres and 226 canisters of 150 litres. Its off-gas purification treatment was particularly effective (DF = 1 to 2×10^8).

The addition of insoluble residues to HLLW is carefully controlled, since the presence of molybdates and platinum type metals in high concentrations may locally affect the homogeneity of the glass and create crystallisation points.

In Japan, research into vitrification techniques by PNC began in 1975 at Tokai mura with small-scale tests. Hot vitrification at the laboratory scale began at the Tokai mura Chemical Processing Facility (CPF) in 1982. The design work for the TVF vitrification unit at this site began in 1980; PNC (now reorganised as JNC) began cold tests of the unit in 1992. It was commissioned in 1995. It had produced 130 canisters by October 2003.

Figure 2.16. The AVM continuous vitrification process
 (Source: COGEMA – France)

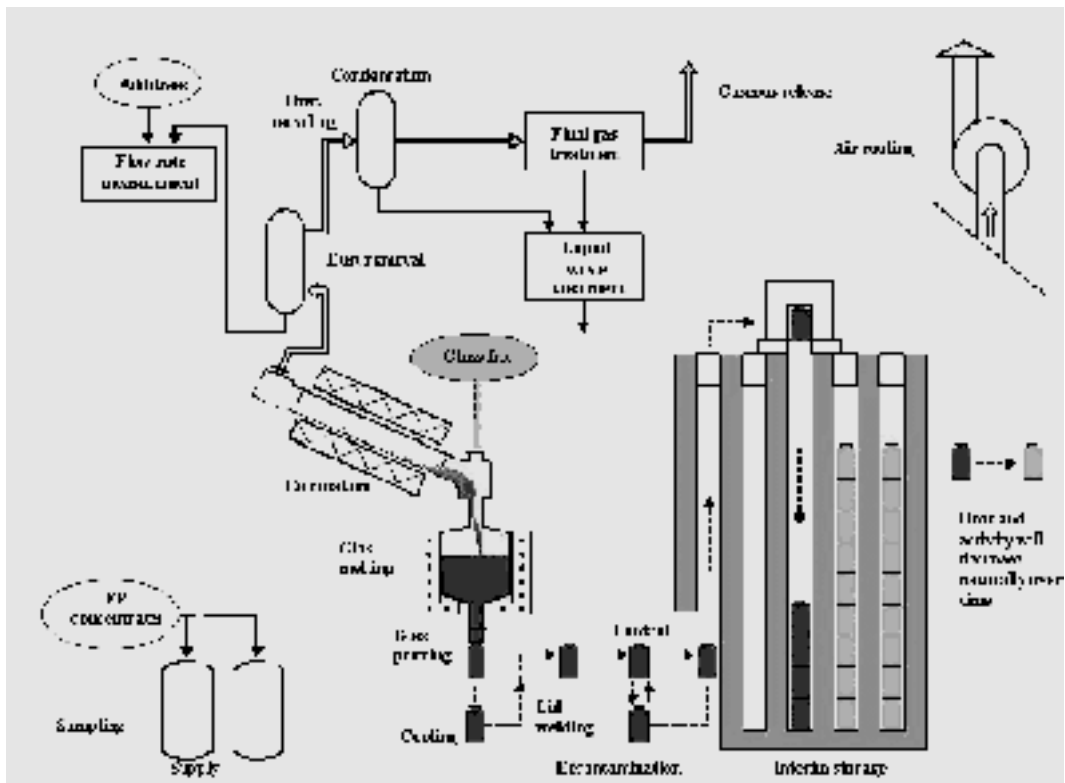

Figure 2.17. Glass pouring in La Hague R7 facility
 (Source: COGEMA – France)



An alternative method of solidification based on the formation of synthetic rock (SYNROC) has been developed in Australia and the United States, from an Australian process, but has not found any industrial application.

2.7.2 High-level waste as a resource

Solutions of highly radioactive fission products and clarification sludges can be considered as an important resource of radionuclides and radiochemical elements. The partition of solutions of fission products into different fractions with potential technological applications has been studied in depth: ^{137}Cs and ^{90}Sr can be extracted from these solutions for use as gamma radiation sources and heat sources. Metals in the platinum family (palladium, rhodium, ruthenium, etc.) are valuable noble metals useful in the catalyst industry. The minor actinides (neptunium, americium, curium, etc.), which are long-lived alpha emitters, can be partially transmuted into shorter lived elements. These techniques have been studied for several decades in Belgium, the United States, France, Japan, the United Kingdom, and at the European Commission Joint Research Centre (JRC) without giving rise to industrial applications. The partition-transmutation option was the subject of the OMEGA programme in Japan [62] and of research arising from an act of parliament passed in France in December 1991.

Caesium (as the chloride) and strontium (as the fluoride) have been separated from solutions of fission products from the defence programme at the Hanford site in the United States. Attempts to use caesium chloride in sealed double-clad sources for industrial irradiation have been undermined by the leakage of caesium from a source [63]. The other types of separation mentioned above have been studied in depth in France [64] and at the JRC [65], but no industrial development has yet been reported. The overall cost-benefit analysis of the safety and radiological impact of these partition-separation processes on the fuel cycle is not yet clear and needs further analysis. Work carried out in France under "Theme 2" of the December 1991 Act has already advanced the subject significantly.

2.8 On-site interim storage of waste

This Section deals only with wastes considered suitable for interim storage prior to final disposal: i.e. deep geological disposal. Any details concerning the interim storage of wastes such as the high-level radioactive liquid waste mentioned above, or building debris, sludge, etc, pending conditioning will be given in the Section dealing with the reprocessing and conditioning of these wastes.

Similarly, the interim storage of spent fuel itself, whether or not it is to be designated as waste, is dealt with in Chapter 6.

Most of this Section deals with the interim storage of conditioned waste arising from the vitrification of highly radioactive liquid waste, which itself arises from the reprocessing of spent nuclear fuel. This waste is characterised by its heat output of the order of 10 to 20 kW/m³ of vitrified product.

Other intermediate and low-level conditioned wastes from reprocessing and their interim storage are discussed at the end of the Section.

2.8.1 *Description of types of interim storage*

There are three main types of interim storage for high-level solid waste to be considered. These wastes are always stored in stainless steel containers of standard dimensions. Where necessary, the containers themselves are placed in an outer packaging.

2.8.1.1 Dry storage

With the first generation of this type of storage, containers are stacked vertically in concrete shafts fitted with a steel sleeve to guide the containers into position. Air vents at the base of the sleeves allow air to circulate between the shaft and the containers and cool the waste. Air circulates either by natural convection or by mechanical action (fans). The air may then be passed through filters before being vented via the stack. The integrity of the outer packaging and inspection for any signs of surface contamination prior to storage ensure that radioactive emissions are negligible or nil.

The second generation is different in that the shafts are closed and cooling air flows outside the shafts. Heat is first transferred through the metal of the shaft before being removed in the cooling air. Containers are enclosed inside the shaft barrier and cooling air does not need to be filtered, to the price of a little less efficient heat transfer. These facilities can all the same operate in natural convection.

The advantage of the dry storage technique is that it provides highly compact storage. It also has passive safety features in that the storage facility is always designed to circulate cooling air by natural convection should the extractor fans, if any, stop operating.

2.8.1.2 Wet storage

This is the same method as the one used for the interim storage of spent fuel. The containers are placed on racks in a pool and immersed. The water for waste cooling is circulated by a pump and is then transferred to secondary heat exchangers and/or a cooling tower, after passing through ion exchange resins to control water salinity and any contamination.

This is also a highly compact storage method. The high thermal capacity and inertia of the water in the pool provide additional shielding against radiation.

However the need for a secondary cooling system, an active safety feature requiring redundant circulating pumps and strict water quality control requirements, because of the possibility of contamination and container corrosion, makes it a less attractive option.

2.8.1.3 Sealed cask storage

This method involves placing one or more containers of vitrified waste in a cylindrical concrete cask. Cask walls approximately 1 m thick provide radiation shielding. The cylinder is also plugged with concrete at both ends. Cooling is by natural convection with air circulating through the annular spaces between the body of the cask and the end plugs. Casks can be stored in buildings of a much lighter construction than in previous designs or even in the open air.

Sealed cask storage is a modular variation of ventilated shaft disposal and has the same advantages as the latter: passive safety and simplicity. It is the most flexible method, allowing use on an “as-needed” basis, although it is not such a compact method.

2.8.2 Current situation

Table 2.2 lists the facilities currently in operation. Only facilities for storing waste from fuel reprocessing in civilian reactors have been included.

Table 2.2. Interim storage facilities

Country	Location	Type	Comments
France	Marcoule	Shaft	National waste vitrified by AVM (gas-graphite reactor waste)
France	La Hague	Shaft	Vitrified waste UP2-800 (national) and UP3-A (foreign prior to reshipment)
United Kingdom	Sellafield	Shaft	National and foreign prior to reshipment (THORP)
Belgium	Dessel	Shaft	Waste from former EUROCHEMIC plant (1 building) + national waste vitrified abroad (1 building)
Germany	Gorleben	Casks	National waste vitrified abroad
Switzerland	Würenlingen	Casks	National waste vitrified abroad
Netherlands	Vlissingen	Shaft	National waste vitrified abroad
United States	West Valley	n.a.	National waste from former West Valley plant. Transfer under study.
Japan	Tokai mura	Shaft	National waste
Japan	Rokkasho mura	Shaft	National waste vitrified abroad, later vitrification of national waste.

This table shows the prevalence of dry storage methods. The following discussion of safety considerations is therefore limited to this method of interim storage.

2.8.3 Other considerations and future prospects

The first storage facility, the Marcoule facility (France) adjoining the Marcoule vitrification plant AVM, was commissioned in June 1978 and has reached 25 years of operation in 2003. Others (see Section 2-2.8.2 above) have been built and brought into service into a number of countries since 1978, either in conjunction with new vitrification plants or for the storage of conditioned vitrified waste under international spent fuel reprocessing contracts. Interim storage of vitrified waste is therefore a proven technology that can now be regarded as mature, regardless of any future developments.

These developments could be driven by changes in the role played by interim storage: from simply being a necessary adjunct to the vitrification process, the storage of containers of vitrified nuclear waste, particularly in the case of the oldest facilities, is acquiring a new status as the last stage before final disposal.

Implementing final disposal is a long term perspective. Without even considering the time frame implicit in the scale of national and international research programmes in this field, or in the

decision-making process needed to open a disposal site, the need to cool vitrified waste prior to disposal dictates that they be kept in storage for a period of around 50 years.

It is barely conceivable that over such a long period no inspections, either systematic or random, would be carried out on waste containers to check that they can be taken from storage and sent to disposal when the time comes. For instance, outside aqueous corrosion of packaging (which can be disregarded at present because the heat generated by the waste rules out any possibility of local condensation) could occur in the later phases of storage if no special provision is taken. Provision should therefore be envisaged to include visual or other inspection programmes in plans for future facility operation. Should final disposal be postponed for one reason or another, this would only serve as further justification for planning inspection programmes.

2.8.4 Other waste

The reprocessing of spent fuel usually generates low and intermediate-level conditioned waste as well.

Depending on the concentration of alpha emitters they contain, this low-level waste can be sent to geological surface or near-surface disposal facilities. The procedures for storage and disposal are the same as for low-level waste from power plants, industrial, medical and research activities (Figure 2.18).

Figure 2.18. EDS LLW drums storage at La Hague (Source: COGEMA – France)



Low-level waste for geological disposal generates only negligible heat and dose rates. Interim storage methods are similar to those for other low-level waste.

Intermediate-level waste arising from reprocessing operations consists in cladding waste and a range of liquid process effluents. While not totally negligible, their thermal output after conditioning is lower than that of HLW by a factor of two to four. Dose rates can be high, particularly for cladding waste.

The low thermal output of intermediate-level conditioned waste means that they can be stored in compact stacks in the building designed to house them. Light ventilation of the building is sufficient to evacuate the heat output of the waste.

Light ventilation is also sufficient to evacuate the small quantities of hydrogen or other flammable gases produced by radiolysis if these waste are encapsulated in a cement or bitumen matrix, thus maintaining the ambient gas concentration below the flammability threshold. With more recent conditioning techniques, cladding waste are compacted and placed in containers similar to those for vitrified waste but with no stabilising matrix.

Anyhow, high dose rates require the use of remote handling systems with operator screens and a heavy-duty storage building.

As for HLW, the long time to disposal suggests that inspection programmes should be planned.

2.9 Transportation

The transportation of radioactive materials has become a major industrial activity which affects all of the nuclear fuel cycle facilities from uranium mining and milling to the final disposal of HLW in an underground repository [66,67,68]. Recommendations for the safe transport of radioactive materials are established in the IAEA; each country defines and enforces regulations based on these. The common basis allows for transboundary movements. The principle is to qualify the containers through severe standardised tests, drop tests followed by a fire test, designed to cover worst case situations encountered in actual transportation. Depending on the quantity of fissile materials or radionuclides, the packages are gradually more mechanically resistant and the regulatory precautions more stringent.

In the front end of the fuel cycle, ores and concentrates are transported in large quantities (millions of tonnes per year) on land and sea between the uranium ore producing centres and the uranium refining plants. In the United States and Canada these shipments take place mainly on land while shipping is the most frequent transportation system between Europe, Africa and Australia. Ore is transported by open trucks between the mine site and the milling plant. The UOC (yellow cake) is generally transported by railway or truck in barrels.

UNH and UF₄ are solid granular substances which are transported as special nuclear materials by truck or railway at a level of thousands of tonnes per year. UF₆ (at low enrichments) is transported in specially designed and equipped cylinders. Transportation is usually made by railway or by ship.

When needed, enriched UO₂ is transported in specifically designed and fabricated containers (e.g. Bu-J type, used in Japan) between the conversion plant and the fuel fabrication plants by modular loads of 25 kg on large trucks loaded with up to 200 packages per truck.

Fuel elements are dispatched in containers from the fuel fabrication plants to the reactor sites by road, rail, ship or air transport. Additional security precautions are taken when plutonium is transported either as plutonium oxide, mixed oxide or MOX fuel elements. Two fuel assemblies of a FBR can be transported on one truck or railcar. In some countries, e.g. the United Kingdom or Germany, plutonium used to be transported as aqueous solution while in other countries, e.g. France, this practice is forbidden. Exceptional precautions are taken when transporting plutonium from one continent to another, e.g. from Europe to Japan, especially during the first major shipment in 1984 and also for the shipment of 140 kg military grade plutonium from United States to France in 2004.

At the back end of the fuel cycle, special transport packages [69] e.g. TN 12, TN 17, TN 24, HZ, EXCELLOX, and CASTOR have been designed and built to transport 5 to 24 spent fuel elements from the LWR site to the away-from-reactor or the reprocessing plant site. These packages which are massively shielded, provided with neutron shielding and heat dissipation fins, are generally transported by railway and/or ships over large distances and, when necessary, transferred by trucks to the reprocessing plants. For each 1 000 MWe capacity, about 27 tHM of fuel elements have to be managed each year. This amounts to more than 10 000 tHM per year throughout OECD countries.

Finally, the high and medium level wastes are transported from the reprocessing site to the storage or repository in specially adapted packages (e.g. TN 12 or CASTOR type for HLW).

2.10 Decommissioning

Decommissioning is the final stage in the life cycle of a nuclear facility. Over the past decade, the number of decommissioning projects has increased markedly.

According to the CEC, decommissioning, as used in the nuclear industry, means the set of administrative and technical actions which are taken to withdraw a nuclear installation from service after its useful life, with adequate regard to the health and safety of the public, of decommissioning workers and of the environment [70]. The ultimate objective of decommissioning is the release of the site for other use after the removal of all significant amounts of radioactivity. More recently the IAEA has suggested a revised definition: The term decommissioning refers to the administrative and technical actions taken to allow removal of some or all regulatory controls from a nuclear facility (except for a repository which is closed and not decommissioned) [71].

The requirements for decommissioning should be considered at the design stage for a new facility or as soon as possible for existing facilities. The later in the facility's lifetime that consideration is given to facilitating decommissioning, the more difficult and costly the decommissioning may become. The difficulty and cost may also be increased by the lack of adequate records and information, the need to install or modify equipment, the increased complexity of decommissioning activities, or because of having to incur additional doses as a result of aspects of the original design complicating these activities [71, §4.1].

Critical tasks for decommissioning nuclear fuel cycle facilities are:

- characterisation of the facility (based on surveys);
- decontamination;
- dismantling;
- demolition;
- surveillance and maintenance (during periods of inactivity);
- final radiological survey/site restoration.

Here the removal of radioactive materials in process and the radioactive waste from normal operations (often referred to as Post Operation Clean Out = POCO) is assumed to be the final act in shutting down the facility. Where this is not the case POCO becomes the first act of decommissioning (after any necessary characterisation).

A number of factors influence the timing of decommissioning, particularly the condition of the facility on shutdown. The specific characteristics of the facility will also influence the timing, as will the availability of waste disposal routes, the recycling of materials (as opposed to disposing of them as

waste) and the resources available. In safety terms, the half-lives of the main radio-nuclides are important parameters. Deferred dismantling may be justified if a significant reduction in radioactivity is expected over time, whereas immediate dismantling is required where long-lived radionuclides predominate [70]. In the United Kingdom, the Government requires that the decommissioning of nuclear plants should be undertaken as soon as is reasonably practicable [72]. The same tendency arises in France, where it is considered that the knowledge of the operators (concerning the installation and its history) is essential for a safe dismantling, when it might be lost if this one is deferred.

Successful decommissioning depends on careful and organised planning. A decommissioning plan should be prepared for each facility [73, §6.2]. This is succinctly expressed by Ceffalo *et al.* [74] as “plan the work, and work the plan”. The extent of the plan, the content, and the degree of detail necessary will vary with the complexity and hazard potential of the facility. The plan must also meet national regulations. In the United Kingdom, the same legislative framework used for operating nuclear facilities is applied to radioactive waste management and decommissioning activities. The United Kingdom Nuclear Installations Inspectorate (NII) has issued a guide for its inspectors entitled *Decommissioning on Nuclear Licensed Sites* [75].

Operators need to “plan for adequate financial resources to ensure the decommissioning of a facility” [73, §3.17]. This is particularly the case for deferred dismantling, where they may be long surveillance and maintenance periods. These financial provisions need to be reviewed periodically and adjusted as necessary to allow for inflation and other factors such as technological advances, disposal costs, and regulatory changes. In general terms, the actual costs of decommissioning tend to be lower for immediate decommissioning than deferred decommissioning. Such cost benefits result from lower surveillance and maintenance costs, along with reduced site infrastructure cost on larger sites. Another factor that influences the money set aside for decommissioning is the assumed discount rate. The discount rate is basically the expected interest rate minus the expected inflation rate for costs that are deferred. The debate in the United Kingdom on decommissioning costs, particularly where there could be long surveillance and maintenance periods is covered in [76,77,78].

There are three stages of planning, i.e. initial, ongoing, and final, the degree of detail increasing from the initial to the final decommissioning plan. The initial plan should be prepared prior to commissioning/operation of the facility and outline the overall decommissioning process [73]. During the operation of the facility the ongoing plan should be periodically updated and made more comprehensive in the light of operating experience. The final decommissioning plan, which itself may need to be modified during decommissioning to take account of unexpected events and other factors, should be initiated prior to final shutdown. The IAEA [71] lists twenty items that should be included, as applicable, in the final decommissioning plan. Safety assessment forms an integral part of the decommissioning plan. The safety assessment “shall be commensurate with the facility or operation” [73, §7.4]. Based on the assessment, the protective measures can be defined so that regulatory requirements can be met.

Nuclear decommissioning projects require innovative thinking and engineering techniques [79]. As such they require suitably qualified and experienced people who understand the technical and safety issues involved, careful planning to allow safe decommissioning and disposal of materials, and a healthy safety culture.

Many people are interested in major decommissioning activities, including employees, regulators, local and national government officials, media, environmentalists and members of the general public. Experience from such activities has shown that regular and effective communication with these “stakeholders” is an important aspect of the decommissioning process [80].

2.10.1 *Decommissioning experience*

CEC research programmes [81] and OECD/NEA collaborative ventures continue to support decommissioning projects on a wide range of nuclear fuel cycle facilities. The IAEA continues to provide guidance on strategic and technical matters based on international consensus (see, for example [82]). On the whole, the results of decommissioning are quite positive, but further improvements in the tools and techniques used would improve the safety and cost effectiveness of decommissioning activities [83].

Moreover, Gordelier [84], based on the successful decommissioning of a number of nuclear fuel cycle facilities (and power reactors) in the United Kingdom, argues that nuclear decommissioning is not an extraordinary task and ought to be considered as liabilities similar to those of other hazardous installations.

Here, the intention is to show the variety of front and back end fuel cycle facilities that have been and are being decommissioned and to highlight a number of important milestones, including the plan to completely decommission a very large site in the United Kingdom.

2.10.2 *Front end fuel cycle facilities*

The key elements of a site-specific risk-based optimisation process in the rehabilitation of uranium mining and milling sites in the eastern part of Germany are described in [85].

The successful decommissioning of the diffusion plant at Capenhurst has demonstrated BNFL's capability of safe and cost-effective decommissioning of a nuclear processing facility [86,87]. A large amount of scrap metal has been released onto the open market, in line with the current United Kingdom regulatory framework that allows the unrestricted use or disposal of previously contaminated material, provided that it falls below specified activity levels. This reduced the volume of low level waste.

The decommissioning activities at the Springfields fuel manufacturing site of BNFL Westinghouse are described in [88]. Laboratories handling HEU dioxide materials have been completely dismantled and demolished, and the site landscaped. Other facilities that handled uranium hexafluoride and/or uranium dioxide are being decommissioned. In such operations, internal radiation exposure from residual contamination encountered while dismantling plant and equipment is a bigger problem than external radiation.

2.10.3 *Back end fuel cycle facilities*

The complete decommissioning of the largest building on the site at Harwell was successfully completed in 1997 when the building was demolished [89]. The successful decommissioning of a small plutonium facility at Winfrith is described in [90]. This was the first time a plutonium facility has been decommissioned to a green field site in the United Kingdom.

A general description of the decommissioning of the former Eurochemic reprocessing plant located at Mol-Dessel is described in [91] and more recent details are given below. An overview of the successful decommissioning of the AT-1 FBR pilot reprocessing facility at La Hague is reported in [92]. The decontamination and dismantling of a ^{238}Pu facility at Savannah River is described in [93]. Since dismantling changes the physical characteristics of the facility, the potential risks to workers

may increase from what they were during operation. The need for adequate ventilation to control the spread of contamination is also highlighted in [93], particularly the need to be able to adjust the ventilation to maintain air flow toward the more contaminated areas as the room shape changes during dismantling operations.

A lead project in the decommissioning of a plant heavily contaminated with plutonium and other actinides on the Sellafield site is described in [94]. This project to decommission a MOX fuel fabrication facility was used to test in situ assay and size reduction methods and improvements in temporary containment and contamination control. The decommissioning of an old plutonium finishing line at Sellafield, which was used to produce plutonium oxide and metal up to 1985, began in 1997 [95]. It is highly contaminated with significant radiation doses and cramped conditions. After considering various decommissioning options in detail, it was concluded that all operations could be carried out remotely. It was reported that, “operations are going well, are being completed within the project programme and well within dose budget”.

Challinor [96] presented a summary of decommissioning experience at BNFL Sellafield (as of 1999). Concluding that “the successful completion of a number of projects and the large number of projects currently undergoing decommissioning demonstrate that fuel cycle facility decommissioning can be safely and cost effectively accomplished”.

In the United Kingdom, the UKAEA (United Kingdom Atomic Energy Authority) have produced a suite of documents that address the overall task of restoring the Dounreay site in the North of Scotland. Taken together, the documents provide an integrated decommissioning and waste management plan for Dounreay – The Dounreay Site Restoration Plan (DSRP) [97]. The DSRP is a living document that gives the current programme and timetable for the restoration of the site. The plan sets out measures that will remove major radiological hazards within the first 25 to 30 years. The major restoration work will be implemented within some 50 to 60 years. On completion of these works, the site will enter a surveillance, monitoring, and maintenance phase for a period currently envisaged to extend to 300 years.

Other countries (Belgium, Germany, France, etc.) have also decommissioned fuel cycle facilities with a good safety record.

2.10.4 Example of decommissioning experience: the Eurochemic plant

The decommissioning and decontamination activities at the main process building of the former Eurochemic reprocessing plant on the nuclear site of Dessel in Belgium by Belgoprocess started in 1990 [98,99].

The main process building is a large rectangular construction of about 80 m long, 27 m wide and 30 m high. Basic inventories are:

Building volume	56 000 m ³
Concrete volume	12 500 m ³
Concrete surface	55 000 m ²
Metal structures	1 500 t

The core of the building consists of a large cellblock of 40 main cells, containing the chemical process equipment. Access areas and service corridors are located on 7 floor level. About 106 individual cell structures have to be dismantled. Some cells have contamination levels up to 125 Bq/cm² (beta) and 200 Bq/cm² (alpha). Some hot spots give a gamma dose rate of several mSv/h. Most of the work involves hands-on operations under protective clothing tailored to each specific task. Adequate tool automation is successfully applied.

Dismantling of the main chemical process building started in 1990 with a limited crew, which was enlarged in 1992 to 24 operators. In 2004, 37 operators are involved in all the decommissioning activities on Belgoprocess, while 8 operators take care of the decontamination work. All activities are assisted, supervised and managed by 12 supervising and management people. Work was carried out in 96 of the 106 individual cell structures to be dismantled. At the end of 2003, 36 cells were decontaminated to background levels. After complete dismantling, concrete decontamination is carried out in 14 other cells. Components/materials have been removed from another 46 cell structures.

2.10.4.1 Aims

The objectives of the decommissioning project are to limit radiation risks to the population according to the universal criteria of the ALARA principle, to bring the building into the non-nuclear category, i.e. to decommission up to a level where no controls on contamination and radiation are required any longer and the ventilation may be shut down, and to decontaminate the building completely in view of a conventional demolition.

Based on fundamental principles of the strategy, Belgoprocess has made a straightforward choice for a strategy with minimisation of amount of materials to be managed as radioactive waste. This objective is achieved using advanced decontamination techniques and the unconditional release of decontaminated materials. Unconditionally released materials are recycled, such as, i.e. metal materials that are removed to conventional melting facilities, or are removed to industrial disposal sites if they have no remaining value.

2.10.4.2 Practical implementation

The practical implementation of the fundamental principles can be found in the use of the decommissioning techniques.

As an example, for concrete surfaces, where the contamination has not penetrated deeply, improvement in operational efficiency was achieved with dry hand held and automated floor and wall shaving systems. These techniques use diamond tipped rotary disks, designed to give a smooth surface finish that is easier to monitor.

For dust-free decontamination of concrete, shavers are integrated into remotely and manually operated industrial systems that capture dust and debris at the cutting-tool surface, which minimises cross contamination.

It was also shown that it is economically interesting to decontaminate metal components to unconditional release levels using an automated industrial dry abrasive blasting installation as radioactive waste.

Other materials such as heavy concrete, electrical cables and wooden pieces are decontaminated using techniques that are selected based on the type of material and the characteristics of the contaminants.

Also, a specific approach was developed for taking representative samples and monitoring concrete material after dismantling and decontamination in view of the final demolition and unconditional release of the remaining structures of the various buildings.

2.10.4.3 Results

The total contaminated material production from decommissioning activities carried out by Belgoprocess from 1990 till the end of 2003 at the Eurochemic reprocessing plant is indicated in Table 2.3.

Table 2.3. Amount of materials from decommissioning at Eurochemic up to 2003 (in kg/y)

Year	Metal	Concrete	Baryte	Others
1990	20 639	23 003	0	9 002
1991	37 466	2 113	0	2 933
1992	61 193	12 796	14 630	6 349
1993	52 576	37 906	27 528	1 785
1994	169 300	48 039	70 587	11 395
1995	120 913	69 040	42 508	11 814
1996	113 908	194 770	71 143	6 926
1997	139 718	126 526	17 842	9 813
1998	86 308	162 052	32 698	45 511
1999	92 291	196 900	2 948	4 423
2000	29 932	120 605	52 453	5 441
2001	73 225	229 552	104 325	6 826
2002	121 168	110 936	13 066	8 158
2003	41 433	61 448	0	3 984
Total	1 160 070	1 395 686	449 728	134 360

More than 75% of the metal material may be unconditionally released for recycling. The concrete material that is produced during the decommissioning operations is mainly removed as radioactive waste. It is only a limited fraction of the total concrete material resulting from the unconditionally release of the building structures, however. On a global basis, about 95% of the concrete material will be unconditionally released and recycled. As this concrete material is free of any polluting substance, it is well suited for reuse as secondary basic material in road construction.

Other materials (all except metal and concrete) will represent only a limited fraction (<1%) of the total produced. As a result of its low economic value and due to the absence of adapted recycling techniques, the non-radioactive part is mostly removed to an industrial dumping site.

As a result, only some 5% of the total material production will be removed as radioactive waste.

Mean individual and collective doses are shown in Table 2.4. below.

Table 2.4. Occupational radiation doses from decommissioning at Eurochemic

Year	Total dose man.mSv	Maximum individual dose mSv	Average effective dose mSv	Number of workers
1990	56.98	5.40	1.35	42
1991	36.52	5.46	0.84	43
1992	31.08	4.07	0.56	55
1993	35.55	3.87	0.63	56
1994	43.52	5.09	0.77	56
1995	46.40	3.99	0.84	55
1996	78.89	9.01	1.55	51
1997	111.49	10.71	2.48	45
1998	64.29	10.61	1.24	52
1999	29.53	2.50	0.56	53
2000	35.42	3.88	0.64	55
2001	63.63	5.74	1.12	57
2002	71.80	6.58	1.38	52
2003	50.70	3.50	1.01	50

3. References

- [1] www.world-nuclear.org/res.htm, *Uranium The Long and Short of It*, World Uranium Reserves (2002).
- [2] www.world-nuclear.org, *World Uranium Mining*, Information Paper (2003).
- [3] NEA (2003), *Nuclear Energy Data*, OECD, Paris.
- [4] Kidson, S. (1994), *Uranium Institute Annual Symposium*.
- [5] Granger, L. (1958), *Uranium and Thorium*.
- [6] Locke, D.H. and Smith, J.R. (1993), *The Nuclear Engineer*, Vol. 34, Issues 3 and 4, May/June and July/August, 1993.
- [7] Page, H. (1979), Proceedings of Advisory Group Meeting on Production of Yellowcake and Uranium Fluorides in Paris, IAEA Vienna, June 1979.
- [8] Page, H. *et al.* (1960), "Processing of Uranium Concentrates and Recycle Residues to Purified Uranyl Solution at Springfields", *British Nuclear Energy Conference*, J 5.4, 272.
- [9] Hawthorn, E. *et al.* (1960), *Tran Inst Chem Engrs*, 38, p. 197.
- [10] Rogan, H. (1973), *Facilities and Technology Needed for Nuclear Fuel Manufacture*, IAEA, Vienna.
- [11] Wilson, P.D. (editors), (1966), *The Nuclear Fuel Cycle – from Ore to Wastes*, Oxford University, Chapter 3.
- [12] European Nuclear Society (2001), *NucNet News*, No. 17, UK.
- [13] Barré, J.Y. (1989), « Les dix ans d'exploitation de l'usine d'enrichissement de l'uranium Georges Besse », *Revue Générale Nucléaire*, No. 5, pp. 369-373.
- [14] Barré, J.Y. (1989A), "Eurodif Prepares for the Future", *Nuclear Engineering International*, December 1989, p. 41.
- [15] Schneider-Maunoury, A. (1989) and Decool, (1986), *Laser and Gaseous Enrichment*, ENC-86 Proceedings, Vol. 5, pp. 383-390.
- [16] Rigny, P. (1989), « L'enrichissement par LASER », *Revue Générale Nucléaire*, No. 5, Septembre-Octobre, pp. 374-376.
- [17] Comaskey, *et al.* (1986), *Atomic Vapour Laser Isotope Separation using Resonance Ionization*, Proceedings 3rd International Symposium on Resonance Ionization Spectroscopy and its Application, Swansea, September 1986, pp. 245-249.
- [18] Takeda, K. (1988), "ASAHI Chemical succeeds in 3% Enrichment", *Nuclear Engineering International*, August 1988, p. 28.

- [19] Combescure, R. *et al.* (1989), «Les Aspects techniques du recyclage de l'uranium de retraitement pour une compagnie d'électricité », *Revue Générale Nucléaire*, No. 5, septembre-octobre, pp. 381-385.
- [20] Butler, G.G. (1986), *Reenrichment of Reprocessed Uranium*. ENC-86, Vol. 4, pp. 127-134.
- [21] Bairiot, H. *et al.* (1999), "Overview on MOX Fuel Fabrication Achievements", International Symposium on MOX Fuel Cycle Technologies for Medium and Long Term Deployment, 17-21 May 1999, AIEA SM.358, Vienna.
- [22] Cadelli, N. (1982), *A Plutonium Recycling Scenario in LWR*, EUR 7768.
- [23] Atomic Energy Commission, Japan (2000), *Long-Term Program for Research, Development and Utilization of Nuclear Energy*, part II, Chapter 3.
- [24] Blanpain, P.; Callens, C.; Gall, W.; Chiarelli, G. and Guillet, J.L. (2001), "MOX Fuel Performance and Development", *Top Fuel 2001*.
- [25] Debès, M. (2001), "Increasing Fuel Burn-up and Reprocessing-Recycling Policy: Two Complementary Means for Competitiveness and Fuel Cycle Equilibrium", *Top Fuel 2001*.
- [26] BNS (2000), *International Conference on the Future of Plutonium*, Conference Report (October).
- [27] Schneider, V.W. and Druckenbrodt, W.G. (1982), "Recent Operating Experience with the AUPuC-Co-Conversion Process", *ENC-3 Transactions of the American Nuclear Society*, Vol. 40, p. 50.
- [28] Oshima, H.; Tamura, T. and Koizumi, M. (1982), "Outline of the Co-Conversion Facility of Plutonium-Uranium-Nitrate Solution to the Mixed Oxide Powder Using a Microwave Heating Method", *ENC-3 Transactions of the American Nuclear Society*, Vol. 40, p. 48.
- [29] US Energy Information Administration, (2003), Office of Coal, Nuclear, Electric and Alternate Fuels; International Nuclear Fuel Cycle Model, January.
- [30] IAEA (1982), *Storage of Water Reactor Spent Fuel in Water Pools, Survey of World Experience*, International Atomic Energy Agency, No. 218.
- [31] Hylko, J.M. *et al* (1989), "Status of Interim Spent Fuel Storage Technologies of Commercial Nuclear Power Plants", *Nuclear Plant Journal*, July-August.
- [32] Garner, G.I. (1989), "Examining the Benefits of Dry Storage and Transport", PATRAM '86 Proceedings, June 1986, Davos, Switzerland.
- [33] PATRAM (1986), "Design and Demonstration of the TN24 Spent Fuel Cask for Dry Storage and Transport", 8th PATRAM '86 Proceedings, June 1986, Davos, Switzerland.
- [34] Klein, K.A., Kouts, C.A., and Barret, L. (1989). *The US Department of Energy's Storage, Transportation and System Integration Activities, Radiation Waste Management & Nuclear Fuel Cycle*, Vol. 12, (1-4), pp. 135-160.

- [35] Bjurström, S. (1986), "Temporary and Permanent Storage in the Swedish System for Direct Disposal for Spent Nuclear Fuel", ENC-4 FORATOM IX: Trans. Vol. 5, pp. 415-424.
- [36] Closs, K.D. (1988), *Status of the Spent LWR Fuel Disposal Activities in the FRG, Safety of the Nuclear Fuel Cycle*, edited by Ebert, K. and von Ammon, R., Weisheim, pp. 322-331.
- [37] Marron, J.F. (1986), *Two Phase Repository Concept in High Level Waste*. Burkholder, H.C. Battelle NW, ISBN 0.935470-29.8, p. 449.
- [38] Benedict, M., Pigford, T.H. and Levi, H.W. (1981), *Nuclear Chemical Engineering*, 2nd Ed., McGraw Hill Book Co., pp. 457-563.
- [39] Yamanouchi, T., Omachi, S. and Matsumoto, K. (1987), "Decadal Operational Experience of the Tokai Reprocessing Plant", RECOD-87, Vol. 1, pp. 195-202.
- [40] *Reprocessing News* (1990), No. 15, February.
- [41] Schmieder, H. (1989), "Status of Reprocessing in the West and Japan", *Nuclear Europe*, 1/2, pp. 40-41.
- [42] Calame-Longjean, A. *et al.* (1987), « Rénovation et Extensions pour la Recherche et le Développement à l'Atelier Pilote de Marcoule », RECOD-87, Vol. 1, p. 115.
- [43] Wilkinson, W.L. (1987), "THORP Takes BNFL into the 21st Century", *Nuclear Engineering International*, August.
- [44] Willax, H.O. and Weishaupt, M. (1987), "Reprocessing Plant Karlsruhe (WAK) Plant Experience and Future Tasks", RECOD-87, Vol. 1, pp. 203-210.
- [45] KfK 4476 (1988), "Sammlung der Vortage Anlässlich des 7", *Statusberichtes des Projektes Wiederaufarbeitung* am 15/16 März.
- [46] Asquith, R.W., Hudson, P.I. and Astill, M. (1987), "The Oxide Fuel Shearing System for THORP", RECOD-87, Vol. 2, pp. 533-540.
- [47] Baetsle, L.H. (1989), "Review of Fire Hazards in Reprocessing Plants", *Proceedings of Fire Protection and Fire Fighting in Nuclear Installations*, IAEA, Vienna, pp. 373-387 (IAEA-SM-305/7).
- [48] James, N.J. and Thomas, P.M. (1989), "Fire Assessment of an Oxide Fuel Reprocessing Plant", *Proceedings Fire Protection and Fire Fighting in Nuclear Installations*, IAEA, Vienna, pp. 435-444 (IAEA-SM-305/70).
- [49] Sheppard, G.T., Berry, R.J. and Henry, P. (1990), "A Nuclear Fuel Cycle Operator's Point of View on the Application of the new ICRP Recommendations to Aspects of Nuclear Safety", *Second International OECD/NEA Conference on Interface Questions in Nuclear Health and Safety*, Paris.
- [50] James, N.J. and Sheppard, G.T. (1989), "Zircaloy Hazards in Nuclear Fuel Reprocessing", *Seminar on The Role of Research and Development in the Nuclear Industry*, I.Mech.E., London.

- [51] Lorrain, B., Saudray, D. and Tarnéro, M. (1987), “Continuous Rotary Dissolver for Light Water Fuels Prototype Tests”, RECOD-87, Vol. 4, pp. 1471-1482.
- [52] Nuclear Engineering International (1989), “BNFL and AEA Technology Use Liquid Pulses in a Continuous Dissolver”, pp. 36-38.
- [53] Kenny, D.A. and Walker, B.J. (1987), “Fast Reactor Fuel Reprocessing Plant to Meet European Needs”, RECOD-87, Vol. 1, pp. 103-113.
- [54] Sasao, N. *et al.* (1987), “Development of FBR Fuel Reprocessing Technology at PNC”, RECOD-87, Vol. 1, pp. 161-168.
- [55] Kleykamp, H. (1987), “The Composition of Residues from the Dissolution of LWR and FBR Fuels in Nitric Acid”, RECOD-87, Vol. 2, pp. 583-586.
- [56] Goumondy, J.P. (1987), “Dissolution of MOX Fuels Research Programme and Preliminary Results”, RECOD-87, Vol. 2, pp. 615-618.
- [57] Schneider, V.W. and Druckenbrodt, W.G. (1982), “Recent Operating Experience with the AUPuC-Co-Conversion Process”, ENC-3 Transactions of the American Nuclear Society, Vol. 40, p. 50.
- [58] Oshima, H., Tamura, T. and Koizumi, M. (1982), “Outline of the Co-Conversion Facility of Plutonium-Uranium-Nitrate Solution to the Mixed Oxide Powder Using a Microwave Heating Method”, ENC-3 Transactions of the American Nuclear Society, Vol. 40, p. 48.
- [59] Cayron, R. and Crispino, E. (1986), “Recycling”, ENC-86-FORATOM IX, Vol. 5, pp. 415-442.
- [60] Alexandre, D., Chotin, M. and Le Blaye, G. (1987), “Vitrification of Fission Products: Industrial Experience and Construction of New Facilities at La Hague”, RECOD-87, Vol. 1, pp. 289-296.
- [61] Kaufman, F. and Wiese, H. (1987), “Vitrification of High Level Liquid Waste”, RECOD-87, Vol. 1, pp. 279-288.
- [62] NEA (1989), “Options Making Extra Gains of Actinides and Fission Products Generated in the Nuclear Fuel Cycle, OMEGA Programme”, GEN/FCC(89)5, OECD, Paris.
- [63] DOE (1990), *Cesium-137: A Systems Evaluation, Encapsulation To Release at Radiation Sterilizers, Inc.*, Decatur, Georgia, Interim Report of the DOE Type B Investigation Group, DOE/ORO-914, July.
- [64] Castaing Report (1982), *Rapport du Groupe de Travail sur la Gestion des Combustibles Irradiés*, Conseil Supérieur de la Sûreté Nucléaire, Rapport de la Commission, Décembre 1981-Novembre 1982.
- [65] Schmidt, E., Zamorani, E., Hage, W. and Guardini, S. (1983), *Assessment Studies on Nuclear Transmutation of Byproducts Actinides*, Final Report CEC-JCR Ispra, SA/I.05-03-83-13.
- [66] Blum, P. (1989), « Les transports du cycle du combustible REP », *Revue Générale Nucléaire*, N° 5 (septembre-octobre), pp. 27-28.

- [67] Lenail, B. and Blum, P. (1989), "Transport Safety at each step of the Fuel Cycle", *Nuclear Europe*, 5-6, pp. 27-28.
- [68] Salmon, A. (1986), "The Transport of Spent Fuel and Radioactive Waste", ENC-4-FORATOM IX, Vol. 5, pp.391-413.
- [69] Christ, R. *et al.* (1987), "Standard Transport/Storage Casks for Long Cooled Spent SWR Fuel", RECOD-87, Vol. 1, pp. 355-358.
- [70] CEC (1995), "Introduction to Handbook of Decommissioning of Nuclear Installations", *Nuclear Science and Technology Services*, CEC EUR 16211, Luxembourg.
- [71] IAEA (2000), "Decommissioning of Nuclear Fuel Cycle Facilities", Safety Standard Services, Draft Safety Guide, DS 171, IAEA, Vienna, has now been published as *Decommissioning of Nuclear Fuel Cycle Facilities*, Safety Guide No. WS-G-2.4, July 2001.
- [72] HMG (1995), *Review of Radioactive Waste Management Policy (Final Conclusions)*, CM 2919, HMSO, London.
- [73] IAEA (2000), *Pre-Disposal Management of Radioactive Waste, Including Decommissioning*, Safety Series No. WS-R-2, Vienna.
- [74] Ceffalo, G.M., Denham, D.H., Gegely, D.E. and Tarpinian, J.E. (1999), "A Radiological Control Perspective on Decommissioning and Restoration Operations Within the DOE Complex at the Hanford Site", Chapter 26, *Decommissioning and Restoration of Nuclear Facilities*, Health Physics Society Summer School, Maddison.
- [75] HSE (2001), *Decommissioning on Nuclear Licenced Sites—Guidance for Inspectors*, HSE (Nuclear Safety Division).
- [76] National Audit Office (1993), *The Cost of Decommissioning Nuclear Facilities*, HMSO, London.
- [77] Science Policy Research Unit (1994), *UK Nuclear Decommissioning: Time for Decision*, Radioactive Waste Management Advisory Committee (RWMAC) Commissioned Research, London.
- [78] RWMAC (1994), *A RWMAC Commentary on the Science Policy Research Unit Report: UK Nuclear Decommissioning: Time for Decision*, HMSO, London.
- [79] Trauber, J. (2000), "Nuclear Decommissioning – A Contractor's Perspective", 7th International Conference on *Decommissioning of Nuclear Facilities*, EA1136, IBC, London.
- [80] Ahlquest, A.J. and Gerusky, T.M. (1999), "Project Chariot Assessment and Remedial Action of 1993: An Alaskan Odyssey", Chapter 27, *Decommissioning and Restoration of Nuclear Facilities*, The Health Physics Society Summer School, Maddison.
- [81] CEC (1998), *The Community's Research and Development Programme on Decommissioning of Nuclear Installation*, Fourth Annual Progress Report, EUR 12338 EN.

- [82] Reisenweaver, D.W. and Laraia, M. (1999), *Decommissioning at the IAEA*, Chapter 21, "Decommissioning and Restoration of Nuclear Facilities", The Health Physics Society Summer School, Maddison.
- [83] Pflugrad, K.A. (1999), "The European Commission's Technological Programme on the Decommissioning of Nuclear Installations", 6th International Conference on *Decommissioning of Nuclear Facilities*, EA 1127, IBC, London.
- [84] Gordelier, S. (1999), *Can We Ever Make a Success of Being Ordinary?* (A Personal Perspective on Decommissioning), Conference on *Nuclear Facilities Decommissioning*, EA 1127, IBC, London.
- [85] Goldammer, W. and Barthel, R. (1994), "Risk Based Optimisation Procedures Applied to the Remediation of Uranium Mining and Milling Sites in Germany", Proceeding of the Symposium on *Waste Management*, WM'94, Volume 1, Tucson.
- [86] Christopher, E.A., Mason, I.J. and Hudson, L.A. (1998), "Materials Recycling and Free Release by BNFL", International Conference on *Nuclear Decommissioning*, I.Mech.E., London.
- [87] Baxter, S.G. and Bradbury, P. (1992), "Decommissioning of the Gaseous Diffusion Plant at BNFL", Capenhurst, Joint American Nuclear Society/European Nuclear Society International Meeting on *50 Years of Controlled Nuclear Chain Reactions: Past Present and Future*. Transactions of the ANS, Vol. 66.
- [88] Darbyshire, C.A. (2001), *Decommissioning Activities at a Fuel Manufacturing Site, Radiation Dose Management in the Nuclear Industry*, BNES, Windermere.
- [89] Abel, M. and Hamblin, C. (1998), "Steven Storeys of Decommissioning, the Complete Dismantling of a Chemical Engineering Building", International Conference on *Nuclear Decommissioning*, I.Mech.E., London.
- [90] Burke, S.P. and Smith, D.I. (1998), "Green Field Decommissioning of an Alpha Facility", International Conference on *Nuclear Decommissioning*, I.Mech.E., London.
- [91] Claes, J., Geans, L. and Meyers, H. (1988), "Decommissioning Project of the Former Eurochemic Reprocessing Plant at Dessel Belgium", International Conference on *Decommissioning of Major Radioactive Facilities*, I.Mech.E., London.
- [92] Cornu, F. and Pelilet, X. (1993), "Pilot Dismantling of the AT-1 Reprocessing Facility at La Hague", 4th Seminar in *Practical Decommissioning Experience with Nuclear Installations in the European Community*, EUR15099, CEC, Mols.
- [93] Smith, R.H. Jr. and Hootman, H.E. (1994), "Dismantlement and Decontamination of a Pu-238 Facility at Savannah River Site", Proceeding of the Symposium on *Waste Management*, WM '94, Vol. 3, Tucson.
- [94] Buck, S. and Colquhoun, A.P. (1988), "Decommissioning of a Mixed Oxide Fuel Fabrication Facility", International Conference on *Decommissioning of Major Radioactive Facilities*, I.Mech.E., London.

- [95] Hodgson, A.J. (1998), “Plutonium Finishing Line III Decommissioning B209 North, BNFL, Sellafield”, International Conference on *Nuclear Decommissioning*, I.Mech.E., London.
- [96] Challinor, S. (1999), “The Sellafield Decommissioning Programme – Reducing Historic Liabilities”, Conference on *Decommissioning Nuclear Facilities*, EA 1127, IBC London.
- [97] DSRP (2000), “The Dounreay Site Restoration Plan” DSRP Issue 1, UKAEA.
- [98] Teunckens, L., Lewandowski, P., Walthéry, R. and Ooms, B. (2003), “The Belgoprocess strategy in decommissioning and decontamination”, *ABR/BVS Conference on Decommissioning*, May 2003, Brussels, Belgium.
- [99] Walthéry, R. (2003), “35th Meeting of the Technical Advisory Group”, OECD/NEA/RWMC, BP-note 2003-05517 of 16.10.2003.

Chapter 3

SAFETY PRINCIPLES

This chapter gives an overall picture of the philosophy that is adopted to ensure high standards of safety in the fuel cycle. All nuclear fuel cycle facilities are subject to regulatory control that requires installations to be designed, constructed, commissioned, operated, and decommissioned with due regard to the safety of workers and to the general public.

The basic safety principles relating to radiation protection are based on international understanding of the effects of ionising radiation. Most countries have adopted the recommendations of the ICRP [1,2], which advocates three basic principles:

- no practice shall be adopted unless its introduction produces a positive net benefit;
- all exposures shall be kept as low as reasonably achievable (ALARA), economic and social factors being taken into account;
- the dose equivalent to individuals shall not exceed the limits established by the appropriate regulatory or licensing body in that country.

The high standards of safety in nuclear fuel cycle installations are achieved by the nuclear industry because, in part, the regulatory bodies require the designers of the facilities to consider not only the need for safety and reliability during normal operation, but also to design against a wide range of potential plant malfunctions, including hazards of both internal and external origin. For example, the safety analysis for nuclear installation will include consideration of explosions, fire, loss of radioactivity containment, criticality, seismic loadings, extreme weather conditions, flooding, and accidental aircraft crash.

In addition to building defence in depth into the design of a plant, the regulatory bodies also require the facilities to be constructed to the highest standards. Operation of the facility is afterwards regularly monitored by the licensing authorities to ensure that operations are carried out in accordance with approved procedures. It is general practice to rely on the safety policies and procedures of the operating organisation as the first line of defence with respect to safety.

The remaining Sections of this chapter describe the regulatory framework that enables plants to be controlled, the treatment of radiological safety and plant malfunctions, the approach used to assess the behaviour of plants under accident conditions and the reporting of nuclear incidents.

1. Regulatory framework

In this Section the role of the regulator and the effects of the regulatory framework on the safety of fuel cycle facilities are addressed. There are differences in regulatory practices in each member country, and only typical examples of these differences are described. The roles of governments and

the regulatory bodies are discussed, together with the steps taken through the regulatory process to ensure that operators of nuclear facilities pay due attention to safety.

1.1 Governmental responsibilities

Nuclear safety policy, in addition to being set and enforced by the regulatory bodies of the respective governments, is a matter of international concern. An IAEA survey [3] of countries engaged in nuclear power programs has shown that, in most countries, consistent policies relating to nuclear safety regulations have been developed. A more comprehensive description of the role of governments in the regulation of nuclear industries is given in [4], which, while primarily aimed at nuclear power plants, is recognised as being applicable to other fuel cycle activities.

IAEA has set up in 1997 the Joint Convention on the Safety of Spent Fuel Management and on the Safety of Radioactive Waste Management, the first legal instrument to directly address these issues on a global scale.

The Joint Convention applies to spent fuel and radioactive waste resulting from civilian nuclear reactors and applications and to spent fuel and radioactive waste from military or defence programs if and when such materials are transferred permanently to and managed within exclusively civilian programs. The Convention also applies to planned and controlled releases into the environment of liquid or gaseous radioactive materials from regulated nuclear facilities.

The Joint Convention includes, in particular, the obligation to establish and maintain a legislative and regulatory framework to govern the safety of spent fuel and radioactive waste management and the obligation to ensure that individuals, society and the environment are adequately protected against radiological and other hazards, inter alia, by appropriate siting, design and construction of facilities and by making provisions for ensuring the safety of facilities both during their operation and after their closure. The Convention imposes obligations in relation to the transboundary movement of spent fuel and radioactive waste and obligation to take appropriate steps to ensure that disused sealed sources are managed safely.

These obligations are based to a large extent on the principles contained in the IAEA Safety Fundamentals document “The Principles of Radioactive Waste Management”, published in 1995 and in the IAEA Code of Practice on the International Transboundary Movement of Radioactive Waste.

The Joint Convention then covers the whole back-end of the fuel cycle, and the waste management and release part of the front end, but only for the countries that have contracted this Convention. As for end of November 2003, 33 countries have ratified it, 23 of them being member countries of the OECD (the ratification list is not closed).

It is important to recognise that the responsibility for the regulation of nuclear fuel cycle facilities rests with governments. However, the responsibility for the safety of workers in these plants and for the general public rests with the operator of the facility. This distributed responsibility provides the basis for the effective regulation of the nuclear industry so that society can enjoy the benefits of nuclear power without being exposed to intolerable risks [5]. To tolerate a risk does not mean it is negligible, nor can it be ignored. Any possible risks to plant workers and the general public must be kept at levels in accordance with national regulations and the ALARA principle.

Governments define and implement the legal framework within which the operator of the facility works. The objectives of such legislation are generally:

- to provide the statutory basis for establishing a regulatory body to oversee the safety of the industry;
- to provide the regulatory body with powers to establish and enforce the necessary regulations with respect to safety;
- to provide the legal basis for ensuring that nuclear fuel cycle facilities are sited, designed, constructed, commissioned, operated, and decommissioned without undue radiological risk to site personnel or the general public and that proper regard is paid to the protection of the environment;
- to ensure the provision of adequate financial indemnification for third parties in the event of any harm that might arise as a result of operations.

1.2 Responsibilities of regulatory bodies

A regulatory body within each respective country has responsibility for full governmental surveillance and control of all matters relevant to the safety of nuclear installations. These responsibilities in general include the siting, design, construction, commissioning, operation, and eventual decommissioning phases of the life of an installation. Governments, in general, ensure that the regulatory body is as independent from any other government agency as practicable. This is to ensure that the regulatory body is not faced with the possibility of conflicting requirements that could compromise its position in the upholding of safety standards. The regulatory body is, in the majority of countries, also independent of the operators of the fuel cycle facilities, the vendors of nuclear equipment, or other related organisations.

The regulatory body has the responsibility to regulate the operations of the nuclear fuel cycle facilities and it does this through its statutory authority given to it by government. The power to regulate the industry is exercised via a licensing process that in general ensures that no person can site, design, construct, commission, operate, or decommission a nuclear facility without a licence. The power of the regulatory body to grant licences carries with it certain responsibilities that ensure that licences are granted and enforced in accordance with well-defined safety principles and associated criteria. The safety principles and criteria that are used to assist the decision-making process in the regulatory body relate to such topics as:

- radiation protection;
- environmental protection;
- nuclear safety;
- structural integrity;
- internal hazards such as fire and explosion;
- external hazards, both man-induced and natural;
- handling and transport of nuclear materials;
- personnel qualification and training;
- inspection, testing and maintenance;
- plant modifications;
- quality assurance;
- emergency planning.
- physical protection;
- nuclear material control and accounting.

The two last points, though important, are not directly related to nuclear safety and can be placed, in some countries, under a different authority.

The regulatory body has a further responsibility to ensure that it has the necessary structure and expertise to deal effectively with its main functions such as review and assessment, licensing, inspection, enforcement, development of regulations and guides, and legal and administrative support.

1.3 Regulations and guides

The regulatory body makes use of regulations and guides as an effective method to obtain the necessary high degree of safety required in nuclear facilities. Regulations give a clear prescriptive statement of what is required of the operator, but they can also be inflexible and can often take long periods of time to change. It is because of this that regulations have limited application in the day-to-day regulation of nuclear fuel cycle plants where flexibility is required to accommodate changes in processes and operations. This flexibility is provided by the use of the licensing process. Guides, however, do not suffer the same problems as regulations as they are usually non-mandatory documents which are intended to amplify and clarify safety principles or other matters relevant to safety.

1.4 Licensing

Licensing processes have been developed to give a flexible and, at the same time, firm control over nuclear safety-related activities. A licence is a legal document that:

- authorises a specific activity or facility;
- establishes requirements and conditions governing the performance of the activity;
- where appropriate, places time limits on the validity of the authorisation.

The licensing process can be considered as an on-going process that is carried out throughout all phases of the facility life. Before a licence is granted, the applicant is required to submit a detailed report on the safety analysis of the proposed plant. An important part of the submission is the Environmental Impact Assessment (EIA) that assesses the impacts of the normal operation of the plant on its environment from all the viewpoints: effects of direct radiations, of radioactive and chemical discharges, economical or sociological, etc. In more and more countries, the stakeholders are involved, particularly local populations through public enquiries for example. The submission is reviewed by the regulatory body to see if an adequate case has been made for the siting of the plant and for the identification and assessment of the risks it poses to both site personnel and the general public. When the regulatory body is satisfied that an adequate safety analysis and evaluation has been made, a licence can be granted.

At the time the licence is granted, it is possible that the detailed design work may not be complete and hence detailed design may proceed in parallel with construction. The regulatory body can control this situation by placing hold points in the construction program or by issuing short-term or limited licences to ensure that design work related to safety systems is done on time. When construction is completed, the operator of the plant is often required to apply for a further authorisation to commence commissioning. At this stage, the regulatory body will require a report showing that the plant has been constructed in accordance with its specifications and that it is

acceptable to commence commissioning. This report will also identify the commissioning requirements in order to demonstrate the operability and safety features of the plant and be accompanied by the emergency plan and the plant operating procedures (Operating Limits and Conditions, Technical Specifications, etc.).

When the plant has been successfully commissioned, the operator is then required to seek an authorisation to commence routine operations. This application will often be accompanied by a pre-operational safety report on the results of the commissioning tests. When the regulatory body is satisfied with the case it will approve final operating procedures and authorise routine operation.

Operating characteristics of a facility are controlled by the conditions of its licence. The procedures for maintenance, inspection, and testing are to be used by the operator of the facility to ensure that safety is maintained. Any change in operating procedures, process and/or feed product and equipment modification that brings changes in the safety case is submitted to specific review and authorisation.

The licensing process also ensures that the safety margin for the plant is periodically reassessed (every ten years, for instance) to check that the original safety case is still complied with and take account of operation lessons learned and possible evolutions in the safety standards. These can derive from operating experience of other plants or from newly acquired data (in physical, chemical, geological fields, for instance).

1.5 Review and assessment

One of the major features of the licensing process is the requirement for the operator, i.e., the licensee, to produce documentation to demonstrate the safety of his operations. Hence the licensee submits safety documentation to the regulatory body at various stages during the life of the plant. The regulatory body determines the adequacy of the safety proposals.

The IAEA Code [6] gives a comprehensive description of review and assessment requirements. The regulatory body not only reviews and assesses the technical details and safety justification for a given plant, it also looks at the licensee's overall management of safety issues. Review and assessment is, therefore, an important and on-going part of the licensing process and, as such, a fundamental requirement in nuclear safety policy.

1.6 Regulatory inspection and enforcement

Another fundamental requirement of the regulatory framework used to ensure adequate nuclear safety standards is the role of the regulatory body in inspection and enforcement. The regulatory body is responsible for checking that the licensee is fulfilling the conditions set out in his licence. This is done by regulatory inspection.

Inspectors have powers of entry to licensed sites and powers to obtain any relevant information relating to the siting, design, construction, commissioning, operation, and decommissioning of the plant. Regulatory inspections can be either announced or unannounced, depending upon their purpose and objective. The principal objectives of an inspection are to check compliance with licence conditions and to monitor the licensee's safety performance.

The method of inspection is a matter for individual countries as geographical location and the number of installations to be inspected can influence the inspection philosophy. Some countries have inspectors based at the regulatory body headquarters who carry out periodic visits to the nuclear site. Other countries have opted for the inspector being based at the site and rely on a reporting back procedure. Where there are logistic difficulties, some other countries have adopted the concept of regional offices to enable the inspector to be sufficiently close to their sites to prevent the need for permanent location at the site.

The legal power to enforce compliance comes from the statutes used to establish the regulatory body. The methods of enforcement vary depending upon the nature of the violation. Minor non-conformance can be handled by a written warning from the regulatory body. More serious problems may require the regulatory body to use its powers to order the licensee to curtail or modify its activities. In the event of chronic or serious non-conformance, such as significant harm to the workforce or the general public arising from the licensee's negligence, the regulatory body could revoke the licence or a particular authorisation.

Enforcement actions can result in penalties of one form or another. The revocation of an authorisation or a licence, or a direction to curtail a particular activity, would almost certainly mean an economic penalty for the licensee. The regulatory body can, in some cases, have the authority to impose direct economic penalties via fines. In some countries, the regulatory body can institute prosecution of the licensee in the courts for serious offences.

1.7 *Quality assurance*

The IAEA Code of Good Practice [7] gives a comprehensive description of quality assurance criteria for the safety of nuclear power plants. Most of these criteria may also apply to nuclear fuel cycle facilities. More and more operators refer to ISO 9000 series. Some countries have specific regulatory documents (United States, Germany, France).

The regulatory body has the responsibility to regulate quality assurance related to safety for siting, design, construction, commissioning, operation, and decommissioning of nuclear fuel cycle installations. It ensures that quality assurance systems and programs are established by the operators, their contractors and suppliers, and enforced in accordance with safety regulations.

1.8 *Emergency preparedness*

The purpose of establishing a regulatory framework to oversee the safety of nuclear fuel cycle facilities is to ensure that such facilities will be designed, constructed, commissioned, operated, and decommissioned with sufficient safety margins such that the risks to site personnel, the public, and the environment are acceptably low. Nevertheless, in spite of all the precautions taken, there is the remote possibility of failures or accidents that could produce an emergency situation. It is therefore a fundamental requirement that adequate preparations are made, and maintained, at local, national and international levels to deal with such situations.

Emergency preparedness involves the participation of many government agencies, including the regulatory body. The regulatory body is often responsible, in conjunction with other government bodies, for ensuring that an adequate emergency plan exists and emergency preparedness is maintained. The licensing process gives the regulatory body the powers to ensure that the licensees'

emergency plans are regularly exercised. Failure to demonstrate adequate emergency preparedness would constitute a serious licence non-conformance.

2. Safety issues

This Section examines the safety assessment procedures carried out to ensure a high standard of safety against the potential hazards induced by radioactivity in the nuclear fuel cycle. All fuel cycle facilities are subject to safety regulations specific to each nation, and are designed in compliance with these regulations, taking into account internal hazards such as fire, explosion, radioactive contamination and criticality, and external hazards such as seismic events, extreme weather conditions, flooding, accidental aircraft crash, fire, explosion, and missiles.

In most of the nuclear fuel cycle facilities, such as uranium mining, milling, conversion, enrichment, fuel fabrication and reprocessing, the radioactive materials to be handled are present in many parts of the facility and, therefore, less concentrated compared with those in the nuclear reactors. Furthermore, the nuclear fuel cycle facilities, including reprocessing facilities, are operated in rather low temperature and pressure conditions and in subcritical conditions so that the potential energy is not sufficient to permit abnormal conditions to rapidly develop into dangerous situations.

2.1 Radiological safety

2.1.1 Radioactive contamination

Protection against radioactive contamination takes the following into account:

- the physical form of the material (massive solid, powder, solution, gas);
- the physical and chemical property of the material (stability, reactivity, volatility);
- the inventory and composition of the material;
- the specific activity of the material and half-life of the radionuclides that it contains, as well as the nature and energy of the radiation it emits;
- the behaviour of the material within the body (biological half-life, concentration in specific organs).

Determination of the inventory of the process materials is an essential first step in any safety assessment.

The control of the spread of radioactive materials is maintained by containment, using physical barriers and clean up systems, associated to discharge and clean up systems control. Containment may consist of:

- the process equipment itself;
- the surrounding cell or glove box;
- the room or building in which the plant itself is located.

Ventilation control of the containment with the discharge of exhaust gases through a stack after a gas cleaning process (e.g. electrostatic precipitators, scrubbers, chemical traps, HEPA filters) can reduce environmental discharges of radioactive material to low levels.

The buildings in which radioactive materials are processed are also divided into zones of increasing degrees of potential radioactive contamination. The ventilation systems are arranged so that the flow of air is from lower to higher regions of potential contamination, thus helping to contain the active material. Access of personnel to each of these zones is controlled and appropriate protective clothing specified. The zones are monitored for surface and air contamination at a frequency appropriate to ensure safety.

2.1.2 Radiation exposure

Personnel in all sections of the fuel cycle are protected against external radiation (i.e. against radiation sources outside the body).

There are three means of maintaining external radiation doses at acceptable levels:

- by shielding;
- by controlling the distance between personnel and the source of radiation;
- by controlling the exposure time of personnel.

In fuel cycle plants, shielding is designed to reduce dose rates to acceptable levels in areas normally accessible to personnel, and permanently installed interlocks and radiation monitors are used to prevent the personnel to access non-shielded zones and accidental withdrawal of radioactive material from these zones towards areas normally accessible to personnel.

Handling of recycled fuel may pose specific radiation control problems because of the different isotopic composition of uranium, the natural decay and the gamma emitting daughter products, and the presence of plutonium and of some gamma-emitting impurities.

2.1.3 Environmental impact and pathways

When considering the impact of fuel cycle processes on the environment, the pathways for, and mechanisms of, release of dispersible radioactive material are first to be considered. The pathways are by direct radiation from the gaseous effluent plume, transfer from contaminated ground, skin penetration, inhalation, ingestion or absorption, and through the food chain.

The movement of radioactive material between fuel cycle sites utilises public highways, railways, and sea or air routes, and during transport the material may pass through significant centres of population. Potential accidental release of radioactive material during transport therefore requires special consideration. In the case of ocean transport, sinking accidents are taken into consideration; and in the case of air transport the consequences of aircraft crash are assessed.

2.2 Criticality

A criticality event is an uncontrolled nuclear chain reaction occurring in an assembly or facility containing fissile materials; it occurs when the geometry, concentration, mass or composition of such an assembly is changed such that the rate of neutron loss from capture or leakage becomes lower than the neutron production rate from fission. Its consequences are a sudden increase of the neutron flux in the system and a corresponding energy release, generally rather low, but with the formation and

possible dispersion of fission products, and the emission of an intense gamma and neutron flux. The most important consequence of such accidents, in an unshielded situation, is the very high direct radiation doses (usually fatal) that might be sustained by operating personnel in the immediate vicinity if personnel were neither warned nor properly protected.

2.3 Chemical hazards

Fuel cycle facilities may be considered as chemical plants, which handle and store large volumes of toxic products and corrosive materials. For example, the production of uranium hexafluoride (UF₆) in the conversion facility involves the use of significant quantities of hydrogen fluoride. Hydrogen fluoride is both a powerful reducing agent and chemically toxic. This poses a significant hazard to workers although hydrogen fluoride is not in itself a radioactive material. In order to reduce risks to workers of the fuel cycle facilities, the chemically reactive and toxic substances are typically classified and controlled.

2.4 Fire and explosion

Many sections of the fuel cycle involve energy releasing or absorbing processes, e.g., dissolution of uranium in nitric acid or evaporation. Many vessels have high heat ratings resulting from fission product heating and require cooling. Hydrogen and oxygen are also produced when radiolysis occurs.

2.4.1 Fire

Flammable material and oxygen are present at certain points in the fuel cycle although often a considerable amount of additional energy is necessary to start combustion. However, since fire is a critical mechanism for the dispersion and release of radioactive materials, due consideration is given to its prevention, detection, minimisation of its escalation, and its extinction. Various plant ancillary systems, including those concerned with off-gas clean-up, are also protected against fire. When deciding on fire-fighting or fire prevention systems in a complex plant, thought is given to possible adverse consequences arising from their use, e.g. pressurisation of a cell or a glove box caused by inerting or injection fire-fighting systems, production of toxic materials, dispersion of radioactive materials within the containment, and moderation of fissile materials that could lead to a criticality event and subsequent clean-up difficulties.

2.4.2 Explosion

In some areas of the fuel cycle, the potential for the creation of an explosive atmosphere exists through the production of hydrogen by radiolysis or the use of this gas in the process, and by chemical or corrosion reactions through the presence of finely divided oxidisable dusts or pyrophoric materials, and through certain nitric acid/heavy metal/organic-matter reactions. An explosion may cause either physical damage such as breach of containment or system pressurisation resulting in an unplanned discharge of radioactive material. In such situations, consideration is given to the use of inert gas atmosphere or dilution systems, and/or to the ability of the containment systems to withstand the explosions that may occur.

2.5 *Equipment failure*

In any facility there is the possibility of equipment and plant failure, resulting in the interruption of some of the essential safety functions, such as containment or cooling. Furthermore, unexpected chemical reactions may occur, for example when normally separated sections of a plant are accidentally interconnected by siphon or a leak path.

To guard against the adverse effects of such failures, various design features are used such as large safety factors in design codes, redundant reliable systems, enhanced monitoring equipment and strict quality assurance.

2.5.1 *Mechanical failures*

Mechanical failures leading to a potential loss of containment or cooling may be gradual, such as those from corrosion or erosion, or sudden, e.g. when a heavy load drops on a valve, a crane collides with a pipe bridge, or a cell window is damaged during a manipulator operation. The gradual failures are detected and repaired before serious consequences arise, as a result of thorough examination, maintenance and inspection testing programs. The sudden ones will require immediate response from the operators and protective systems.

2.5.2 *Malfunction of control systems*

Computer control systems have been introduced in nuclear fuel cycle facilities to allow repetitive or complex control functions and thus reduce human errors. Such systems also have the possibility for malfunctions. Some malfunctions are attributed to mechanical system failures, while other malfunctions can be attributed to software systems and computer itself.

Malfunctions in mechanical systems are caused by breakdowns in the mechanical systems themselves, mainly caused by failures in parts such as sensors, connectors, or actuators. The operation of these mechanical parts is periodically checked and maintenance usually prevents failure in these parts. Malfunctions caused by fundamental operating software are usually prevented by pre-operational and validation tests. Software modifications have to be very carefully managed (qualification of modifications, prevention against uncontrolled modifications, etc.). An important part of computer control system design consists of redundant systems to improve their reliability, thus minimising downtime or operational loss of control caused by single failure in the computer system. Furthermore, mechanical systems and their associated control systems are, as far as possible, of safe design (i.e. a failure leads to a safe state).

2.6 *Operator error*

The degree of automation or computer control in the fuel cycle plants is very advanced, but there is ongoing intervention by man, and thus the possibility for operator error still exists. It is therefore possible that an operator error, or inaction, can either generate or cause some deterioration in maintaining system safety or a failure to take corrective actions. Plant and processes are designed and the plant operated in order to minimise this possibility. Operators are furthermore adequately trained to follow formal written instructions enabling them both to carry out routine operations and to respond to abnormal conditions.

2.7 External events

When reviewing the safety of nuclear fuel cycle facilities, the role of external events as possible causes of accidents is examined. External accidental events may be natural (e.g. floods, earthquakes, forest fires, tornadoes) or man-induced (e.g. accidental aircraft crashes, projectiles or unconfined vapour cloud explosions from adjacent sites or transport routes). Site selection and plant design play an important part in minimising these risks, and certain controls on off-site activities, such as overflying the site, may be required. Although an accidental aircraft crash on the relatively small target of a nuclear fuel cycle site would have a very low probability, protection against it may have to be provided depending on site conditions and facility operations. Decisions regarding the design measures that are required to minimise possible external event induced risks are based to a large extent on statistical and historical data.

2.8 Loss of electrical power

To ensure that safety features can fulfil their function, the plant's electrical power supply is designed so that the necessary power can be supplied by either off-site or on-site power sources in the event of an emergency. In particular, special provisions are taken to ensure sufficient redundancy and diversity for both off-site and on-site sources, as needed in regard of safety.

2.9 Loss of utilities

Some utilities can be necessary to ensure that safety features can fulfil their function, such as water, steam or compressed air feed and cooling systems. Special provisions are taken to ensure sufficient redundancy and diversity for these utilities, to fulfil the needs determined by the safety case.

3. Safety assessment procedure

Radiation doses to the public from the routine authorised release of radioactive effluents from nuclear fuel cycle plants are assessed as completely and as realistically as possible. Corresponding operating limits are imposed on the facilities in the licences. Section 12-2 presents the discharges or impact of some fuel cycle facilities.

In the assessment of the consequences of potential internal and external abnormal events, the deterministic technique is generally used. In using the deterministic assessment approach, a design basis event (DBE) is selected and its impact evaluated to prove the adequacy of the facility design. A DBE is an artificially supposed event, considered as the upper bounding event, against which measures are taken when designing the facility. As a result of its evaluation, a number of other events or incidents of lesser consequence will be mitigated by the safety measures. Another approach in assessment, the probabilistic technique, is used complementarily. In the selection of external events, statistical and historical data are considered.

The following are considered in the safety assessment:

- safety-related experience from plant operation, including that from relevant conventional industries;
- identification of potential abnormal events;
- estimation of the possibility of the events;

- determination of scenarios and assessment of the consequences of such events in appropriate units in relation with the nature of the consequences.

3.1 Identification of fault situations

The safety assessment requires the application of professional training, experience, and judgment using techniques such as hazard and operability surveys (HAZOP) [8], failure mode, and effect analysis [9,10] or cause/consequence diagrams, to ensure thorough examination of the whole system using systematic approaches. The aim is to identify all mechanisms that may create hazardous situations. These may differ in nature – physical, mechanical, or chemical properties – or may be due to operator error and therefore may cover a range of occurrences such as over-pressure, loss of vacuum or inadvertent mixing of reagents. In the deterministic approach, possible DBEs and their scenarios are examined according to the above considerations.

3.2 Fault tree analysis

Estimation of the possibility of a DBE relies on experience and engineering judgment. In some cases, a probabilistic technique using fault tree analysis might be used to determine its probability quantitatively.

Fault tree analyses are detailed deductive analyses of specific situations which identify conditions that could lead to a stated event, usually a failure. After the undesired events (top events) are identified, a fault tree should be constructed that models the system conditions that can cause the undesired event. In this case, care should be taken to consider human errors and common failure modes. The fault tree graphically traces the sequences of individual failures to the final event [11].

The purpose of constructing a fault tree is to determine the probability of the undesired top event (Probabilistic Safety Assessment). This is done by the application of available fault rate data and statistical techniques to the sub-system. Data on operator response and reliability is built up from reactor operation experience, specifically commissioned research and industry wide studies. It is however frequently a source of much debate in this context.

The difficulty is then to take into account the uncertainty of the result and establish acceptance criteria.

The advantage of this method is that the building of the logical model gives a powerful tool to perform sensitivity studies and sort out the initial causes, so that one knows where improvements have to be made to lower the probability of the undesired event.

Some regulators, such as US NRC, are trying to set risk-informed regulations, based on such probabilistic assessments. The main difficulty seems to be in the definition of the figures of the safety goals (criteria). Progress reports show there is still much work to be done on this subject before practical application takes place.

3.3 Assessment of consequences

A DBE is determined according to the scenarios covering the effects of significant possible events. In assessing the consequences, technically approved analytical models are used together with

reliable data. The behaviour of process systems during the event is determined in order to fully evaluate the possible consequences. It might be unrealistic to assume that, for example, in the event of a fire, the total plant inventory of radioactive materials would become airborne, but knowledge of the fraction that could be released would be important. Thus such a situation would require selection of specific values for:

- a) the fraction of the total inventory of the affected unit that will be involved in the incident;
- b) the fraction of a) that will be released from the bulk of the material;
- c) the fraction of b) that will escape from the containment to the working areas or to the outside environment.

In some situations, accident progression occurs over a long period of time, thus allowing remedial actions to be taken. A typical example of this is the loss of cooling in a radioactive liquid waste storage system. In this case, it would be necessary to evaluate the system's temperature and the radioactivity of release transients. These have to be related to the possibility of cooling restoration or other remedial actions that might reduce or prevent releases.

Some information is available on these topics [12,13,14,15,16,17,18,19]. Where relevant, it can be applied to specific accident assessments. In some cases, application of small-scale experimental data to plant conditions may be valid. Information on actual plant incidents is frequently not well collated and related to design parameters.

It is also necessary to calculate the dispersion through the biosphere of any radioactivity that is released from plant containment and the radiological consequences for the surrounding population, generally using appropriate computer programs [20,21].

4. Event severity scale

Safety hazards associated with nuclear fuel cycle facilities have been demonstrated by operating experience with these facilities during the last 50 years. Review of the list of events with the IAEA/OECD/NEA International Nuclear Event Scale (INES, Figures 3.1 and 3.2) indicates on the order of 104 events at non-reactor nuclear fuel cycle facilities from 1992 (beginning of its applicability to these facilities) up to October 2003.

The international scale is divided into seven levels. The lower Levels are termed incidents (1 to 3) and the upper Levels (4 to 7) are called accidents. Events that have no safety significance are classified as below scale/level zero. Industrial accidents or other events which are not related to nuclear plant accidents are not classified on the scale; these are termed out-of-scale [22,23]. Events are considered in terms of three broad categories; off-site impact, on-site impact, and safety system degradation.

- The first category applies to events resulting in off-site release of radioactive material. Understandably, the public is most concerned with such releases. Level 7, the highest on the scale, corresponds to a major nuclear accident with widespread health and environmental consequences. Level 3, the lowest rating in this context, represents a very small release that would result in a radiation dose to the most exposed members of the public equivalent to a fraction of the prescribed annual dose limit for the public. Such a dose is typically about one tenth of the average annual dose from exposure to natural background radiation.

- The second category considers the on-site impact of an event. The range is from Level 5, typically representing a situation of severe damage to the facility, down to Level 3, at which there is major contamination and/or overexposure of workers.
- The third category applies to events involving the degradation of a plant's safety system. All plants are designed so that a succession of safety systems acts to prevent major on-site and off-site impacts, the defence-in-depth concept. The degradation of the defence-in-depth classifies events as Levels 3 through 1.

Figure 3.1. The major INES scales

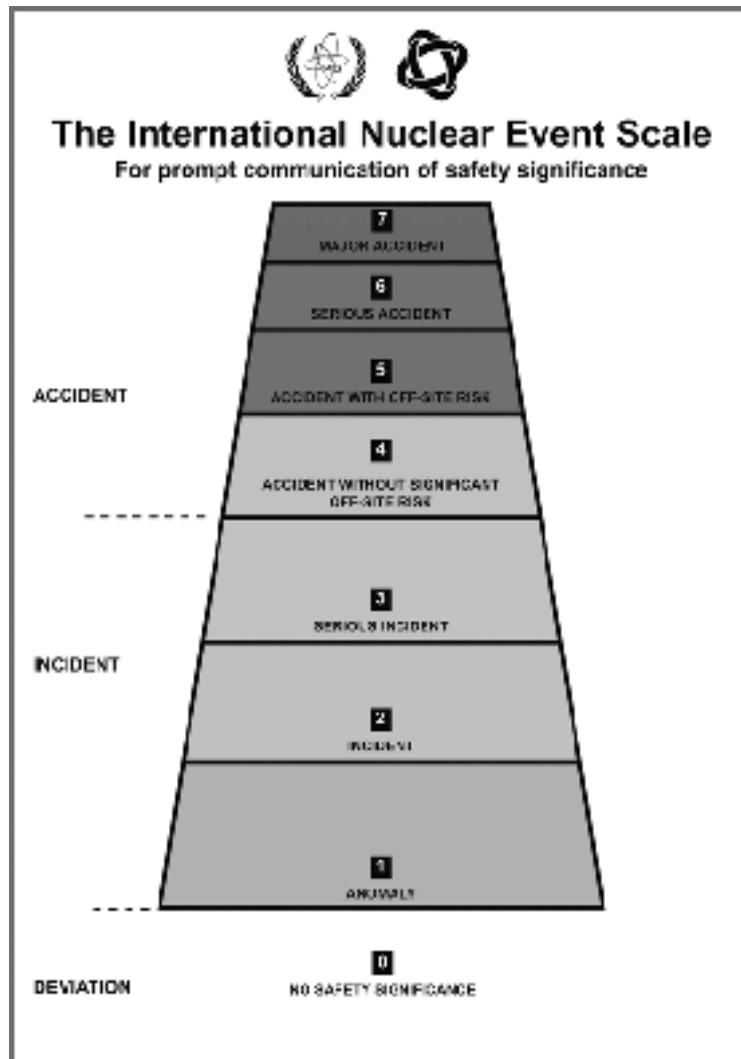

Figure 3.2. Detailed explanation of INES scales

LEVEL/ DESCRIPTOR	NATURE OF THE EVENT	EXAMPLES
ACCIDENTS 7 MAJOR ACCIDENT	<ul style="list-style-type: none"> External release of a large fraction of the radioactive material in a large facility (e.g. the core of a power reactor). This would typically involve a mixture of short and long-lived radioactive fission products (in quantities radiologically equivalent to more than tens of thousands terabecquerels of ¹³¹I). Such a release would result in the possibility of acute health effects; delayed health effects over a wide area, possibly involving more than one country; long-term environmental consequences. 	Chernobyl NPP, USSR (now in Ukraine), 1986
6 SERIOUS ACCIDENT	<ul style="list-style-type: none"> External release of radioactive material (in quantities radiologically equivalent to the order of thousands to tens of thousands of terabecquerels of ¹³¹I). Such a release would be likely to result in full implementation of countermeasures covered by local emergency plans to limit serious health effects. 	Kyshtym Reprocessing Plant, USSR (now in Russia), 1957
5 ACCIDENT WITH OFF-SITE RISK	<ul style="list-style-type: none"> External release of radioactive material (in quantities radiologically equivalent to the order of hundreds to thousands of terabecquerels of ¹³¹I). Such a release would be likely to result in partial implementation of countermeasures covered by emergency plans to lessen the likelihood of health effects. Severe damage to the installation. This may involve severe damage to a large fraction of the core of a power reactor, a major criticality accident or a major fire or explosion releasing large quantities of radioactivity within the installation. 	Windscale Pile, UK, 1957 Three Mile Island, USA, 1979
4 ACCIDENT WITHOUT SIGNIFICANT OFF-SITE RISK	<ul style="list-style-type: none"> External release of radioactivity resulting in a dose to the most exposed individual off-site of the order of a few millisieverts.* With such a release the need for off-site protective actions would be generally unlikely except possibly for local food control. Significant damage to the installation. Such an accident might include damage leading to major on-site recovery problems such as partial core melt in a power reactor and comparable events at non-reactor installations. Irradiation of one or more workers which result in an overexposure where a high probability of early death occurs. 	Windscale Reprocessing Plant, UK, 1973 Saint-Laurent NPP, France, 1980 Buenos Aires Critical Assembly, Argentina, 1983
INCIDENTS 3 SERIOUS INCIDENT	<ul style="list-style-type: none"> External release of radioactivity resulting in a dose to the critical group of the order of tenths of millisievert.* With such a release, off-site protective measures may not be needed. On-site events resulting in doses to workers sufficient to cause acute health effects and/or an event resulting in a severe spread of contamination for example a few thousand terabecquerels of activity released in a secondary containment where the material can be returned to a satisfactory storage area. Incidents in which a further failure of safety systems could lead to accident conditions, or a situation in which safety systems would be unable to prevent an accident if certain initiators were to occur. 	Vandellos NPP, Spain, 1989
2 INCIDENT	<ul style="list-style-type: none"> Incidents with significant failure in safety provisions but with sufficient defence in depth remaining to cope with additional failures. These include events where the actual failures would be rated at level 1 but which reveal significant additional organisational inadequacies or safety culture deficiencies. An event resulting in a dose to a worker exceeding a statutory annual dose limit and/or an event which leads to the presence of significant quantities of radioactivity in the installation in areas not expected by design and which require corrective action. 	
1 ANOMALY	<ul style="list-style-type: none"> Anomaly beyond the authorised operating regime with significant defence in depth remaining. This may be due to equipment failure, human error or procedural inadequacies and may occur in any area covered by the scale, e.g. plant operation, transport of radioactive material, fuel handling, waste storage. Examples include: breaches of technical specifications or transport regulations, incidents without direct safety consequences that reveal inadequacies in the organisational system or safety culture, minor defects in pipeworks beyond the expectations of the surveillance programme. 	
DEVIATIONS 0 BELOW SCALE	<ul style="list-style-type: none"> Deviations where operational limits and conditions are not exceeded and which are properly managed in accordance with adequate procedures. Examples include: a single random failure in a redundant system discovered during periodic inspections or tests, a planned reactor trip proceeding normally, spurious initiation of protection systems without significant consequences, leakages within the operational limits, minor spreads of contamination within controlled areas without wider implications for safety culture. 	NO SAFETY SIGNIFICANCE

*The doses are expressed in terms of effective dose equivalent (whole dose body). Those criteria where appropriate can also be expressed in terms of corresponding annual effluent discharge limits authorised by National authorities.

An event that has characteristics represented by more than one criterion is always classified at the highest level according to any one criterion.

The scale has been originally designed for use in nuclear power plants, but it has been refined in 1992 and extended to be applicable to any event associated with radioactive material and/or radiation, including the transport of radioactive materials, giving a means for promptly communicating and facilitating common understandings from the nuclear community to the media and the public.

The 1999 criticality accident at Tokai mura with a rating of 4 is the highest level event reported outside reactor field since INES is applicable to fuel cycle facilities. The hazards associated with nuclear criticality at these facilities were reviewed at the ICNC 1999 Conference [24]. The conference reported that nearly 60 criticality accidents have occurred since 1945, about a third of which occurred at nuclear facilities other than reactors, but not necessarily in fuel cycle facilities. Of these, 21 accidents killed 7 people and resulted in significant radiation exposure to another 40 individuals. Although most of the accidents occurred before the early 1980s, two occurred as recently as 1997 and 1999. Twenty of these accidents involved processing liquid solutions of fissile materials, while none involved failure of safety equipment or faulty calculations. The conference identified the main cause of criticality accidents as the failure to identify the range of possible accident scenarios, particularly those involving potential human error. This finding is especially significant for fuel cycle facilities given the extensive reliance on operator and administrative controls to ensure safety they often use.

These findings are valid as far as there are comprehensive procedures that are enforced and workers are sufficiently trained.

Similar hazards have been demonstrated by other operational events and accidents. For example, chemical toxicity hazards associated with UF₆ processing were evident in two accidents in 1986 in the United States and Germany. Fire and explosion hazards have also been evident in the safety record at fuel cycle facilities.

In 1990, for example, there was an ammonium-nitrate reaction in an off-gas scrubber at a low-enriched uranium (LEU) scrap recovery plant in Germany, which injured two workers and destroyed the scrubber. Fire is an especially significant accident scenario because it can be both an initiating event for the accident sequence and a disrupter of safety systems as well as an energy source to transport radioactive and chemical contaminants into uncontrolled areas where they may harm members of the public. An example of this is the fire and explosion at the Tokai Reprocessing Plant in March 1997, which contaminated at low level some areas of the facility and workers and was rated at 3 on INES.

5. References

- [1] ICRP (1977), Publication No. 26, Pergamon Press.
- [2] ICRP (1990), *1990 Recommendations of the International Commission on Radiological Protection*, Annals of the ICRP, Publication No. 60, Vol. 21/1-3.
- [3] IAEA (1988), *Analysis of Replies to an IAEA Questionnaire on Regulatory Practices in Member States with Nuclear Power Programs*, TECDOC-485, Vienna.
- [4] IAEA (2000), *Legal and Governmental Infrastructure for Nuclear Radiation, Radioactive Waste and Transport Safety*, Safety Series Code No. GS-R-1, Vienna.

- [5] Health and Safety Executive (1987), "The Tolerability of Risk from Nuclear Power Stations", United Kingdom.
- [6] IAEA (1988), *Code of Good Practice*, Safety Series No. 50-C-G (Rev. 1), Vienna.
- [7] IAEA (1979), *Code of Good Practice*, No. 50-C-QA, Vienna.
- [8] Lawley, H.G. (1974), "Operability Studies and Hazard Analysis", *Chemical Engineering Progress*, Vol. 70, No. 4.
- [9] USNRC (1975), "An Assessment of Accident Risks in the United States Commercial Nuclear Power Plants", Reactor Safety Study, WASH-1400 (NUREG-75/014) USNRC.
- [10] Smith, T.H. *et al.* (1976), "A Risk-Based Fault Tree Analysis Method for Identification, Preliminary Evaluation, and Screening of Potential Accidental Release Sequences in Nuclear Fuel Cycle Operations", BNWL-1959.
- [11] Bourne, A.J. *et al.* (1981), "Defense Against Common-Mode Failures in Redundancy Systems", SRD-R-196, January.
- [12] Walker, E. (1981), "A Summary of Parameters Affecting the Release and Transport of Radioactive Material From an Unplanned Incident", BNFO-81-2.
- [13] Charlier, A. *et al.* (1984), "Use of BR3 for the Belgian Plutonium Recycle Irradiation Program", IAEA, Specialists Meeting on Improved Utilization of Water Reactor Fuel with Special Emphasis on Extended Burn-ups and Plutonium Recycling, SCK•CEN, Mol.
- [14] Mishima, J. (1976), Potential Aerosol Generation Mechanisms from Damaged Shipping Packages, BNWL-5742, July.
- [15] Ballinger, M.Y. *et al.* (1988), "Aerosol Released in Accidents in Reprocessing Plants", *Nuclear Technology*, Vol. 81, p. 278.
- [16] Halverson, M.A. and Mishima, J. (1986), "Initial Concepts on Energetics and Mass Releases During Non-nuclear Explosive Events in Fuel Cycle Facilities", NUREG-CR-4539 (PNL-5839) USNRC.
- [17] Briand, A. *et al.* (1986), "Limit of HEPA Filters Operating under High Temperature Conditions", 19th DOE/NRC Nuclear Air Cleaning Conference.
- [18] Shiomi, H. *et al.* (1982), "A Parametric Study on Removal Efficiency of Impregnated Activated Charcoal and Silver Zeolite for Radioactive Methyl Iodine", 17th DOE Nuclear Air Cleaning Conference.
- [19] USNRC (1988), "Nuclear Fuel Cycle Facility Accident Analysis Handbook", NUREG/CR-6410.
- [20] Fryer, L.S. and Kaiser, G.D. (1978), "Tirion 4 – A Computer Program for Use in Nuclear Safety Studies", SRD-R-134.

- [21] Togawa, O. (1990), “Computer Code TERFOC-N to Calculate Doses to Public Using Terrestrial Foodchain Models Improved and Extended for Long-Lived Nuclides”, *Journal of Nuclear Science and Technology*, Vol. 27, p. 360.
- [22] NEA (1990), “The International Nuclear Event Scale”, edited by OECD/NEA and IAEA, Paris.
- [23] IAEA (2001), “The International Nuclear Event Scale – User’s manual – 2001 Edition”, jointly prepared by IAEA and OECD/NEA, Vienna.
- [24] ICNC (1999), Proceedings of the Sixth International Conference on Nuclear Criticality Safety, 20-24 September 1999, Versailles, France.

Chapter 4

GENERAL SAFETY

This chapter contains a discussion of the general safety matters associated with the fuel cycle, including hazards of both radiological and non-radiological nature.

Malevolent actions can be oriented towards nuclear fuel cycle facilities or radioactive matters transportation, the same way as they could be oriented towards any other dangerous product, activity or facility such as chemical or explosives factories. Protective measures against such actions are not specific to nuclear facilities, they are dealt with by specialists and their details are kept confidential. These are the reasons why they are not addressed in this report. It can be noted, however, that some measures necessary to ensure nuclear safety, such as containment, heavy radiation shielding, design to withstand earthquakes or accidental plane crashes, for instance, can help in the defence against malevolent actions.

In most of the nuclear fuel cycle facilities, the radioactive materials are in an easily transportable and dispersible form, as a gas, in solution, or as a finely divided powder. However, the temperatures and pressures typically encountered are substantially lower than in nuclear reactors and, as the plant is operating in nuclear subcritical conditions, deviations are therefore unlikely to develop rapidly into dangerous situations. Nevertheless, the radioactive materials encountered in fuel cycle facilities may be very diverse and in a number of chemical and physical forms; they are often linked to flammable or chemically reactive substances as part of the process. While automation has increased, operators often are still intimately concerned with management and control of processes. The interaction and superposition of chemical, mechanical, and nuclear hazards lead to some very specific potential scenarios, from which man and the environment are protected by good design and construction of facilities and their safe operation.

1. Radiation

Radiation safety is an important consideration at nuclear fuel cycle facilities. Special attention is warranted to ensure worker safety because of their possible contact with radioactive material in the process. Potential intakes of radioactive material require careful control to prevent and minimise contamination and to adhere to operational dose limits. In addition, releases of radioactive material into the facilities through monitored and unmonitored pathways can result in significant exposures, particularly from long-lived isotopes. Some facilities, such as MOX fuel fabrication, reprocessing, and vitrification facilities require careful attention to shielding design, containment, ventilation, and maintenance procedures to reduce exposures.

1.1 Radiation protection programme

A facility should have in place a radiation protection programme that is adequate to protect the radiological health and safety of workers and the public and ensure that the exposures are ALARA. To accomplish this, facilities evaluate and characterise the radiological risk and typically provide sufficient robust controls to minimise this risk. Potential accident sequences are considered in assessing the adequacy of the controls, which aim to minimise radiological risk and contamination.

Good fuel cycle facility radiation protection practices include:

- an effective documented programme to ensure that occupational radiological exposures are ALARA;
- an organisation with adequate qualification requirements for the radiation protection personnel;
- approved written procedures for conducting activities involving radioactive materials;
- radiation protection training for all personnel who have access to restricted areas;
- a programme to control airborne concentrations of radioactive material with engineering controls and respiratory protection;
- a radiation survey and monitoring programme that includes requirements for control of radioactive contamination within the facility and monitoring of external and internal radiation exposures;
- other programmes to maintain records, to report radiation exposures to the regulating authority, and to reinstate an acceptable in-plant radiological environment in the event of an incident.

The implementation of such programmes regarding direct radiation is now made much easier with the use of individual electronic dosimeters of credit card size that can instantly alert the holder when instantaneous or cumulated dose reach programmed thresholds, that keep in memory the history of exposure and whose data can be downloaded to computers, for example each time the operator enters or leaves the controlled zone, so that these data can be automatically recorded and analysed. Thus, detailed exposure provisions can be checked versus actual exposures, allowing improvement of both working methods and provisions.

The development of computerised monitors that allow the visualisation of dose rates is also a powerful tool for radiation protection.

1.2 Containment and ventilation

The levels of radioactivity in fuel cycle installations vary depending on the radionuclides concerned; preventive measures, however, are always taken to reduce the hazard to workers associated with ingestion or inhalation, hence the use of containment structures and a ventilation system. In some cases, there is the added hazard of chemical toxicity, which may even become the dominant potential risk for uranium handling, or as in the case of handling UF₆, because of the possible formation of hydrogen fluoride.

The uncontrolled dispersion of radioactive substances to the environment can only occur if the successive containment barriers, separating these substances from the environment, are all impaired. A containment barrier may be afforded by:

- the process equipment itself;

- the surrounding cell or glove box;
- the surrounding room or building.

Radiotoxic materials (plutonium, fission products, etc.) are handled in leak-proof cells located, wherever possible, inside a second containment barrier. Facilities are housed in a building which acts as the final containment barrier to the environment.

Containments cannot be absolutely leak-tight in all circumstances, either because of technical impossibilities (large concrete-shielded cells in reprocessing plants) or because certain operations involve temporary break of containment. Examples of temporary breaks are when equipment or products are being introduced or removed or an incident such as a pierced glove during glove box operations. Containment systems are therefore augmented with dynamic containment supplied by means of a ventilation system, designed so that pressure inside the containment is always lower than outside. In this way a cascade of reducing absolute pressure is established between the outside, inside the building and inside the different containments so that in the event of a leak, air flows towards the more contaminated zone, preventing radioactive particles or gases to escape.

Ventilation of these containments, with discharge of exhaust gases through a stack via a gas-cleaning equipment (e.g. scrubbers, chemical traps, HEPA filters and electrostatic precipitators), can reduce environmental discharges of radioactive materials to very low levels. The ventilation system may also be regarded as part of the containment system.

1.3 Containments

Primary containments vary in type depending on the products involved and their radiotoxicity. They are located as close as possible to the radioactive materials handled. In some cases, especially for liquid phase operations, primary containment may be provided by the equipment used for the process. In this case, there should be no communication between the inner part of the equipment and the cell or glove box in which it is installed. This requires that the venting system of the equipment be completely isolated from the cell ventilation.

1.3.1 Uranium enrichment

Regardless of whether the process is GD or ultracentrifugation, containment is provided by the equipment, which is highly leak-tight as a fabrication quality requirement. Secondary containment consists of the cells housing the most sensitive systems, or the building itself, so that in the event of an accident release into the environment is kept to a minimum. It should be noted that the dominant hazard arises from the toxicity of the HF gas produced through hydrolysis of UF_6 in contact with air moisture, but adequate preventive measures are taken into account in the design of such facilities to minimise the risk of such a release.

1.3.2 Uranium fuel fabrication

At UO_2 fuel fabrication facilities, containment is required for furnaces converting UF_6 to UO_2 , and wherever UO_2 is present in powder form (crushers, mixers and compacting presses). The latter equipment is not leak-tight and systems are installed to draw off dust and aerosols to keep atmospheric contamination in the buildings within acceptable limits. The tendency is to lower exposures, especially

systematic inner exposures, and thus to install such equipment in glove boxes – which in turn allows the easier treatment of reprocessed uranium.

1.3.3 PuO₂ or MOX fuel fabrication

Since plutonium is a highly radiotoxic element by inhalation, all operations are carried out in highly leak-tight glove boxes. The glove box itself becomes the containment barrier for the protection of operators.

1.3.4 Reprocessing

Owing to the large amount of radionuclides in spent fuel (plutonium, fission products, and activation products), all operations are conducted in containments.

For liquid phase operations (fuel dissolution, plutonium, uranium and fission products separation, uranium and plutonium purification, etc.) the equipment acts as the first containment barrier. It is made of materials of suitable composition (stainless steel, zirconium) and thickness for the physical and chemical operating conditions, to minimise the risk of failure. Special attention is paid to the design and quality of equipment, especially relating to welds. In the event of a leak, solutions are recovered in secondary containment to prevent any radioactive liquids from contaminating the ground.

The equipment is installed in shielded cells that act as the second containment barrier and protect personnel against gamma and neutron radiation.

For dry operations, the equipment cannot always provide the first containment barrier. Such is the case in fuel element shearing, which generates gases and aerosols. The shielded cell is the first containment barrier in that situation. Cell contamination therefore has to be kept to a minimum. This is achieved by using suitable ventilation systems that pick up most of the gases and aerosols produced at source (hoods, air curtains). Likewise, operations handling PuO₂ powder require precautions to ensure that the contamination of glove boxes is minimised when they act as the first containment barrier.

1.4 Ventilation

Nuclear installations are equipped with ventilation systems that provide several safety functions, including:

- Dynamic containment to counteract any leak-tightness failures of the static containment in the different envelopes. Ventilation provides a cascade of reducing absolute pressure to ensure that air flows from the buildings where personnel are present, toward the hot cell and the containments housing radioactive materials.
- Treatment of the gaseous effluents discharged from the equipment and, where applicable, treatment of the air drawn from the buildings by routing the gases and air to suitable apparatus (such as filters, traps) before being released into the environment. Gaseous effluents are monitored.
- Renewal and conditioning of air in the buildings to ensure an adequate working environment.

- Monitoring the ventilation air for contamination serves as a warning mechanism for the identification of breaches of containment.

The level of importance placed on the safety functions of ventilation systems is evaluated for each type of installation and application. For the most sensitive installations, dynamic containment might be necessary on a permanent basis. In this case, the ventilation system is designed for an extremely high reliability (back-up power supply, equipment redundancy). Monitoring systems, checks, and periodic testing as well as maintenance procedures are provided.

Proper ventilation system design maintains an effective dynamic containment for all plant operating conditions, including accident situations considered to be plausible. Special attention is also paid to fire hazard by ensuring that:

- the ventilation system does not worsen the situation, for instance, by allowing fire to spread through the ventilation ducts;
- where possible, the ventilation system itself is used to control fire development (presence of fireproof dampers, pre-established ventilation procedure in case of fire);
- where possible, equipment is fireproof;
- the last filtration stage prior to release into the environment remains sufficiently effective that it would not lead to unacceptable releases (filter resistant to higher temperatures, suitable location in the ventilation system).

2. Criticality

Criticality safety is one of the dominant safety issues for fuel cycle facilities. These facilities employ a great diversity of technologies and processes, thus the materials of interest to safety are distributed throughout these facilities. They may be used not only in a bulk form (fuel pellets, fuel rods, fuel elements, etc.), but in the distributed and mobile forms as well (different kinds of solutions, slurries, gases, powders, etc.). This is in contrast to reactors, where the bulk of the nuclear material is located in the reactor core or fuel storage areas. As a result the fissile materials may accumulate in some parts of the equipment and may also escape from the containment as a result of equipment leakage. This distribution and transfer of potentially critical nuclear material requires operator attention to account for this material throughout the installation and thus to ensure that nuclear criticality safety is maintained and to prevent the potentially lethal effects of gamma and neutron radiation doses to workers and the subsequent release of fission products from an inadvertent nuclear criticality.

All areas of fuel cycle facilities that process or contain fissile material need to be evaluated for criticality hazards. The evaluation must show whether the presence of fissile materials (e.g. enriched uranium, plutonium) presents a plausible scenario for an inadvertent criticality during the processing being conducted at the facility. As regards nuclear criticality, fuel cycle facilities may be split into two groups:

- facilities where a criticality hazard is not plausible, such as mining, milling, and conversion of natural uranium facilities;
- those where the criticality hazards may be plausible, such as enrichment, reprocessing, uranium fuel fabrication, MOX fuel fabrication, fresh fuel storage (and transportation), spent fuel storage (and transportation), waste treatment, and waste disposal facilities.

Facilities in the latter group need to be designed to ensure subcriticality in all areas, first by engineering design, utilising criticality-safe designed equipment where possible. These facilities need to be operated in a manner that provides a high level of assurance that critical parameters and controls are maintained. This includes assurance that excessive amounts of fissile material do not accumulate above the specified limits in vessels, transfer pipes and other parts of the facility.

To prevent inadvertent nuclear criticality, process safety limits must not be violated, and safety limits must have enough margins to preclude criticality during postulated abnormal operating condition. Particular attention should be paid to fissile material in the waste stream, process changes or modifications that may be inadequate (from the point of view of criticality), nuclear material accounting and control procedures that may lack the appropriate accuracy to ensure subcriticality, and controls that are used to prevent the accumulation of nuclear materials outside processing equipment in zones that are not included within the design (powder build up or solidified salt deposit by drying of a minute leak, for instance).

Fuel cycle facilities with credible criticality hazards should have in place a programme to ensure subcriticality. Provision should be made to cope with an accident and to notify the facility personnel should an inadvertent criticality occur. Adequate emergency preparedness should be foreseen, where appropriate.

This topic is also discussed in Section 7 (7.1.1.3, 7.2.1 and 7.3.2.3).

2.1 Criticality safety

All operations with fissile materials outside nuclear reactors are performed in such a way as to prevent the establishment of nuclear chain reactions and the concomitant release of energy. Though the energy would manifest itself principally as heat in the particular medium, the associated ionising radiation might be lethal to nearby personnel without their being aware that an incident has occurred, or without any apparent damage being sustained by the process equipment; the only indication of any untoward occurrence may be the sounding of radiation alarms. Additionally, damage to equipment could be caused resulting in the possible escape of fission products generated by the incident and perhaps additional radioactive materials, particularly if irradiated materials were being processed. Damaged equipment would result in the interruption of operational schedules and could lead to the dispersal of sufficient active material to present a severe decontamination problem or an environmental hazard. Achieving criticality depends upon:

- the properties of the fissile material;
- the mass of fissile material present and its distribution among the components of the system being assessed;
- the mass, nature and distribution of all other materials associated with fissile material.

Modes of control of criticality safety in any process include, but are not limited to, any one or a combination of the following:

- control of the mass of fissile material present in an equipment;
- control of the geometry (limitation of the dimensions and/or shape) of the process equipment;
- control of the concentration of fissile material in solutions;
- the presence of appropriate neutron absorbers;
- the limitation of moderation, when it can be guaranteed that hydrogenous substances cannot be present.

The control of criticality safety by the above methods can be achieved by:

- equipment design;
- the use of process control instrumentation;
- compliance with operating procedures.

Where possible, maintaining control depends either on safety features incorporated in the equipment or on the instrumentation rather than on administrative control.

2.2 Factors affecting criticality

A number of factors should be considered, both singly and in combination for a proper analysis of criticality safety. Some of the more important factors are considered below.

2.2.1 Moderation

The presence of neutron moderation material mixed with or placed near fissile material can substantially reduce the mass of fissile material necessary to achieve criticality. Water, oil, and similar hydrogenous substances are the most common moderators present in the handling and the processing of fissile material. Except when it can be guaranteed that such substances cannot be present, design calculations are performed with moderation leading to the maximum reactivity, for instance with mist instead of water if heating power is present.

2.2.2 Reflection

The most effective neutron reflector commonly encountered in handling and processing fissile material is water in a thickness sufficient to yield maximum nuclear reactivity. However, careful consideration should be given to systems where significant thickness of other common structural materials (e.g., wood, concrete, steel), which may be more effective neutron reflectors than water, may surround or cover an appreciable fraction of a container surface.

Where the extent of neutron reflection by such partial or potential reflectors as vessel walls, supports, or personnel bodies cannot be assessed accurately, or the possibility of neutron reflecting materials being introduced accidentally by flood or fire-fighting cannot be discounted, the most effective reflector conditions should be assumed in all assessments. If limitation of reflecting material can be guaranteed, appropriate relaxations are permitted.

2.2.3 Interaction

Consideration should be given to neutron interaction between units when more than one unit containing fissile material is present. It is possible to reduce neutron interaction to acceptable proportions either by spacing items or by insertion of suitable neutron moderating and absorbing materials between items, or by some combination of these methods.

2.2.4 Neutron absorbers

Equipment and processes can conform to the requirements of criticality safety by the use of neutron-absorbing materials, such as cadmium, boron, hafnium and gadolinium, providing their suitability has been confirmed and their presence can be ensured. The use of solid neutron absorbers in

the construction and assembly of equipment is preferred; the use of solutions of neutron absorbers is less desirable because their presence has to be confirmed regularly through procedures and chemical controls. Neutron absorbing materials are most effective for neutrons of thermal energy. Care should then be exercised to ensure that their effectiveness is not seriously reduced in operational or accident conditions, which might change the fissile assembly into one characterised by neutrons of intermediate or high energy.

2.3 Possible abnormalities

The effect of the occurrence of possible abnormal conditions should be considered in the assessment of criticality safety. These include such factors as:

- loss or introduction of moderating material into or between units of fissile material, through e.g. evaporation, precipitation, dilution, flooding;
- introduction of neutron reflecting material near units of fissile material;
- change of shape of fissile material due to occurrences such as vessel leakage or breakage;
- change in operating conditions, e.g. loss of flow, precipitation, excessive evaporation, violation of mass limits;
- change in conditions of neutron interaction, e.g. collapse or overturn of equipment, passage of fissile material in transport.

2.4 Assessment philosophy

Wherever possible, the specification for criticality safety should be established on bases derived directly from experiments. In the absence of directly applicable experimental measurements, the results of calculations are acceptable provided the calculations are qualified by comparison with relevant experimental data.

In all specifications the margin of safety should be commensurate with the uncertainty in the basis of the assessment, the probability of its violation, and the seriousness of the consequences of a conceivable criticality accident.

Operations should, in general, incorporate sufficient safety features to ensure that two independent concurrent changes, each of low likelihood and reliably detectable, must occur in the conditions originally specified as essential to criticality safety before the system may become critical. Following any actual occurrence of one of these changes, the safety of the process should be re-evaluated. This is generally known as the double contingency principle.

2.5 Criticality accident

The probability of a criticality accident is inherently extremely low in plants processing only LEU and/or mixed plutonium-uranium oxide in dry solid form. It is higher in other plants, especially those in which uranium and plutonium are handled in solution.

Experiments of criticality excursion carried out in France with HEU solutions (CRAC and SILENE programme), in Japan with LEU solutions (NUCEF-TRACY programme) and criticality accidents that have actually occurred in the United States, the United Kingdom, and the Russian

Federation show that an accident leading to 5×10^{18} fissions, corresponding to a total energy of 40 kWh, is a reasonable envelope hypothesis. However, greater yields are conceivable for large volumes of solution, for which the duration of the excursion would be longer. A criticality excursion of 5×10^{18} fissions could not have serious mechanical or thermal consequences and these would be negligible beyond the site boundary. From the radiological point of view, direct radiation or the release of fission gases may necessitate temporary sheltering or evacuation of population, following the type of accident (dry or wet) and the local conditions. In those parts of a plant where there is no adequate radiation shielding, a reliable criticality accident detection and warning system is installed. Escape routes and emergency procedures are pre-planned and regular emergency drills practiced by the staff.

A criticality accident occurred at the uranium processing facility in Tokai mura, Japan, in 1999. Two people were killed, making this Japan's worst nuclear incident. The basic cause of this accident was the unsafe working procedures used by the staff as a result of insufficient training along with severe violation of regulations.

A summary of criticality accidents that have occurred in nuclear plants is given in Section 12-3.

3. Chemical hazards

Fuel cycle facilities also pose hazards to workers and members of the public from releases of chemically toxic and corrosive materials. They may be considered as chemical plants, which handle and store large volumes of toxic products and corrosive materials. Major steps in the nuclear fuel cycle basically consist of chemical processing of fissile materials. This processing involves the use of strong reagents to dissolve the materials so that the needed chemical reactions may take place.

For example, the production of uranium hexafluoride (UF_6) in the conversion facilities involves the use of significant quantities of hydrogen fluoride. Hydrogen fluoride is both a powerful reducing agent and is chemo-toxic. This poses a significant hazard to workers, although the hydrogen fluoride is not in itself a radioactive material.

Other examples include the use of strong acids to dissolve uranium and other materials and to remove, in some cases, the fuel cladding. They are also used to chemically dissolve the spent fuel during fuel element reprocessing, enabling the separation of the plutonium and uranium from the fission products. In addition, the separated fission products, which comprise approximately 99% of the total radioactivity in the spent fuel, pose a significant radiological hazard in what is typically a complex chemical slurry.

During the solvent extraction process, strong acids and organic solvents are used to remove the plutonium and uranium from the fission products. These processes can generate toxic by-products that must be sampled, monitored, and controlled. Other chemicals encountered at fuel cycle facilities in industrial quantities include ammonia, nitric acid, sulphuric acid, phosphoric acid, and hydrazine.

The chemical risks for fuel cycle facilities are integral to the nuclear processing. Consequently, assurance of safety requires control of both the chemical and nuclear hazards.

In addition, unplanned release of the chemicals may adversely affect safety controls. For example, a release of hydrogen fluoride could disable an operator who may be relied upon to ensure safe processing.

In order to reduce risks, the chemically reactive and toxic substances are typically classified and controlled. A robust chemical risk control process would include process descriptions with sufficient detail to support an understanding of the chemical process risks (including radiological risks caused by or involving chemical accidents) and would allow understanding of potential accident sequences involving chemical processes.

Appropriate methods should be used to estimate the concentration or to predict the toxic footprint of a release to the environment of hazardous chemicals from a plant utilising hazardous chemicals to process radioactive materials. The tolerability of the toxicological consequences should be assessed against appropriate chemical exposure standards.

Chemical exposure standards are available from a variety of national and international organisations, e.g. relevant ISO standards. Fuel cycle facilities should be designed and operated in a manner that ensures that the risks of hazardous chemical exposure and contamination are controlled and minimised.

4. Fire and explosion hazards

Fire and explosive safety is also an important issue for fuel cycle facilities. Many of the facilities use flammable, combustible, and explosive materials in their process operations, such as a TBP-kerosene mixture for solvent extraction, bitumen for conditioning radioactive waste, hydrogen in sintering furnaces, and chemical reagents for oxide reduction.

Typical design of the facilities is conducted to minimise the inventories of combustible materials and ensure adequate control of thermal processes and ignition sources to reduce the potential for fire and explosions. For example, extreme care is taken to prevent accumulation of radiolytic hydrogen, which is generated in high activity waste tanks in reprocessing plants.

In addition, fire can become a motive force for significant releases of radioactive and toxic material from the facilities. Consequently, fire detection, suppression, and mitigation controls are usually necessary.

A fuel cycle facility typically considers the radiological and other consequences from fires and explosion. Suitable safety controls are instituted to protect the workers, the public and the environment from the potential consequences of a fire and an explosion. These safety controls are designed to provide the requisite protection during normal operations, anticipated operational occurrences, and credible accidents at a facility.

4.1 Fire hazards – General

The safe use of radioactive substances requires barriers to ensure adequate protection for workers and the environment. The purpose of these barriers is to provide either static or dynamic containment for potential contaminants or biological shielding against radiation hazards. Their efficiency, however, may be reduced or even neutralised in the event of a fire. Requisite measures should be taken to ensure that the likelihood of such an event is minimised.

Practices used by OECD countries to deal with fire hazards may differ. The following sections deal with some general topics based mainly on French practice [1].

In comparison with nuclear power plants, where a major effort has been made to standardise protection procedures, the hazards encountered in fuel cycle facilities vary considerably and a special fire hazard analysis should be carried out for each individual installation. With older installations, analyses of this kind allow safety authorities to determine what improvements are needed to meet current safety standards. In order to carry out these analyses, some member countries have developed special design codes and expert systems that they use in conjunction with existing technical rules and regulatory requirements or guides.

The analysis of fire hazards involves identifying the causes of fires, assessing their potential consequences and, where possible, estimating the probability of such fires occurring. However, although these estimates can provide valuable information on which to base decisions or to identify weaknesses that might otherwise have gone undetected, they need to be used with caution. Certain protective measures might have to be taken, even though the probability of fire occurring may seem low, whenever there is a possibility that a fire may have significant consequences with regard to nuclear safety.

Analysis of fire hazards involves a sequential review of the provisions made for preventing, detecting and fighting fires.

4.2 *Fire hazard analysis*

A distinction must be made between conventional hazards commonly encountered in industry, such as those involving electrical equipment that are well known and that depend in particular on the fire load, and those relating specifically to a given process used at an installation.

Examples of the latter in reprocessing plants include:

- the risks arising from the presence of pyrophoric Zircaloy fines in irradiated fuel element chopping/leaching operations;
- the risks associated with the use of the flammable solvents used in the PUREX process in irradiated fuel reprocessing.

4.3 *Fire prevention measures*

Prevention is undoubtedly the single most important aspect of fire protection. Facilities should be designed to limit fire risks by taking measures to ensure that fires do not break out and that, were a fire to break out despite the precautions taken, its consequences would be limited. A number of both general and specific measures are taken to accomplish this two-fold aim, consisting principally of:

- Minimising the fire load of individual rooms.
- Choosing materials according to functional criteria and fire-resistance ratings; thus, building-components and equipments are made as much as possible from materials considered to be non-combustible.
- Compartmentalising buildings as far as possible to prevent fires spreading. Buildings should be divided into fire areas. Should a fire break out within a given fire area, it must not be able to spread beyond the sector. The higher the fire risk, the greater the number of areas a building should have.

One very important aspect of fire hazard analysis is determining which rooms require special consideration. Rooms are categorised under three main headings:

- Rooms with high fire loads.
- Rooms housing safety-related items of equipment. Items of equipment that fall under this heading are associated with a function that is important to safety, i.e. items whose degradation might have radiological consequences considered to be unacceptable.
- Rooms whose degradation might have direct or indirect radiological consequences that would be considered to be unacceptable. In rooms in which radionuclide activity levels are high, there is a constant risk of radioactivity being released.

One item that requires particular attention is the design of ventilation systems. Dynamic containment comprises ventilation ducts and filter units which, unless they are of suitable design, may constitute weak points in the system.

Fire dampers are mounted in selected ventilation systems to close automatically either on receipt of a signal from the fire-detection system or by direct thermal activation.

Electrical cable specifications must ensure that they cannot provide a path along which fires can spread and that they release minimal amounts of smoke and toxic or corrosive gases when exposed to fire.

It is of prime importance that periodical checks are made in operation to ensure that subsequent modifications do not compromise the initial fire load rating or compartmentalisation philosophy.

4.4 *Fire-detection systems*

Analysis of fire hazards will identify the rooms and containments that need to be fitted with fire-detection systems. Fire detectors are fitted by an approved installer and are in accordance with well-defined rules. The alarm is relayed to locations where help may be summoned immediately (facility control room, emergency team command post).

4.5 *Fire-fighting resources*

Compared with conventional industries, the nuclear industry poses certain constraints in this respect:

- difficulty or impossibility of gaining access to the fire (danger of irradiation, special clothing for fire fighters);
- the need to maintain a certain level of containment (in order to limit releases of radioactivity to the working place and/or the environment);
- restrictions in terms of the extinguishing agents that may be used: in accidents involving a risk of criticality, for example, the use of water may be prohibited.

4.6 *Periodic inspection and safety instructions*

To ensure efficiency and operability, the above-mentioned fire protection systems may call for the introduction of a number of measures such as:

- periodic testing, inspection, and maintenance of the devices associated with fire protection systems (extinguishers, fire dampers, fire detectors, fire doors);
- general and detailed orders for fire fighters;
- fire-fighting plans;
- fire drills, including off site fire fighting organisations if relevant;
- training for operating staff and emergency teams in fire and explosion prevention and mitigation.

4.7 *Explosion hazards*

At the difference of fire, explosion hazard is limited to specific areas that have specific causes and require specific prevention measures. These are dealt with in the corresponding chapter of the individual stages of the fuel cycle.

The main possible generators of explosions are (most of them in the reprocessing or waste conditioning processes):

- the use of hydrogen in the sintering furnaces of fuel fabrication;
- the explosive combustion of zirconium powder;
- the decomposition of hydrazoic acid;
- the reaction of solvent (“red oil”) with nitric acid in evaporators;
- the production of hydrogen by radiolysis;
- the oxidation of U(IV);
- the use of reducing agents (hydrazine, etc.);
- the use of solvents and diluents;
- the use of formaldehyde in evaporators;
- the presence of nitrites in resins and bitumen.

5. Maintenance

Maintenance of fuel cycle facilities may also pose special safety hazards. For example, although fuel cycle facilities all require some degree of maintenance for operations and safety, maintenance of some of these facilities requires special care during design and operation due to the foreseeable high radiation or toxic hazards present and the required use of hot cells and glove boxes for some maintenance operations. These facilities include vitrification, reprocessing, and MOX fuel fabrication plants.

In addition, maintenance may in itself pose special hazards because it may be an initiating event for accident sequences if it is not performed in an acceptable manner. However, other than for facility-specific design considerations, these risks are not significantly different from those that are usually taken into consideration for reactor maintenance.

Maintenance measures are normally performed at a facility on a continuing basis, with emphasis on equipment relied on for safety, to ensure the equipment is available and able to perform its

functions, including those functions required to prevent accidents or mitigate the consequences of accidents, when needed. Most facilities have commitments relative to how equipment relied upon for safety is inspected, calibrated, tested and maintained, to a level commensurate with the equipment's importance to safety, to ensure its ability to perform its safety functions when required.

A facility maintenance programme generally should address the following maintenance activities: corrective maintenance, preventive maintenance, surveillance, monitoring and functional testing. Corrective maintenance includes a commitment to promptly perform corrective actions to remediate safety equipment failures and a description of the approach and methods for planning and implementing repairs to safety equipment with the objective of eliminating or minimising the recurrence of failures.

Preventive maintenance includes a commitment to conduct preplanning and scheduled periodic refurbishing of safety equipment, with a description of the activities required for preventive maintenance such as instrumentation calibration and testing, and the methods used to establish the frequency of preventive maintenance activities. Collection of failure rate and failure modes used for that purpose can also be used to reinforce the reliability studies of the safety analysis.

Surveillance and monitoring includes a commitment to design and implement a programme to survey and monitor the performance of the safety equipment and includes a description of the components of the surveillance and monitoring programme, including the methods used to establish the frequency of required inspections for safety equipment.

Functional testing includes a commitment to perform the appropriate post-maintenance functional testing to provide a reasonable assurance that the maintenance activity did not adversely affect the reliability of the safety equipment, along with the establishment of a general description of functional testing and the documentation of the test results.

6. Human factors

6.1 Introduction

Human factors is the discipline which specialises in developing and promoting an environment that supports the performance of people.

People are fallible, and even the best make mistakes. However it is possible to predict, manage and reduce the impact of the situations which would challenge the performance of even the most capable of individuals. The importance of the contribution that human factors make is well recognised throughout the international nuclear community [2].

Human factors need to be considered for fuel cycle facilities to alleviate potential safety issues. Human factors should be considered during the design, operation, and maintenance of fuel cycle facilities. Most of the technological process at fuel cycle facilities includes essential safety operations that utilise a man/machine interface. Since most of the inadvertent condition upsets at fuel cycle facilities are a result of human error, human factors considerations are of paramount importance during fuel cycle facility operation. This is particularly true when technology changes are introduced or when equipment modifications are performed.

A central aspect of human factors is the training and qualifications of the personnel who operate fuel cycle facilities. The rigor and formality of the training programme for a fuel cycle facility is really

a function of the safety issues encountered at the facility and the resulting complexity of the training needed. In general, fuel cycle facilities provide assurance that only properly trained and qualified personnel perform activities relied upon for safety at fuel cycle facilities. Human factors should be taken into account when developing operational and safety procedures. Establishment of good safety culture is considered an important factor contributing to the safe operation of all type of fuel cycle facilities.

6.2 Definitions

The UK HSE (Health and Safety Executive) defines human factors as “the environmental, organisational and job factors and human and individual characteristics which influence behaviour at work in a way which can affect health and safety” [3]. They break this complex description down into three component elements:

- The individual: people bring personal characteristics to work such as skills, attitudes and personalities that are a result of their previous experiences. It is important that the impact of these characteristics is considered. One clear example is to assess the skills of individuals to determine training requirements, a more complex example is to understand the role of risk perception in the behaviour of people at work.
- The job: by considering how the job is designed and the equipment people have to manipulate it is possible to influence the effectiveness of people at work. Equipment and processes should be designed in accordance with ergonomic principles that take into account the strengths and limitations of human capabilities.
- The organisation: one of the most influential factors on group and individual behaviour is that of the organisation, although this area is often overlooked. It is important to nurture a positive culture that supports the behaviour that is required of the workforce. This area of work takes into account aspects such as leadership, communication and culture assessment [4].

These three components of human factors that the HSE define can be overlapped with three of the human factors specialisms. While this is a broad and simplistic generalisation it could be argued that the individual is supported through the human reliability discipline, the job is supported through ergonomics and the organisation is supported through organisational psychology.

6.3 Human reliability

Human reliability is about ensuring that the components of the task are designed to minimise the risk of failure. It is particularly important to be able to assess the reliability of human performance in a high hazard environment.

Human performance is affected by a variety of factors normally called performance shaping factors or PSF's. There are many such factors that can either act alone or combine together to affect in different ways the reliability of an operator, some examples are given below:

- the familiarity of the operator with the task that he is carrying out;
- the time allocated to complete the task;
- the design or operability of the plant;
- the lack of understanding of the task objectives;
- the frequency and duration of task interruption.

The reliability of a person is also affected directly by the type of task that is being undertaken. J.T. Reason [5] has classified the different types of task as:

- Skill based: where an operator has, through training and practice, acquired a skill that he can now perform without much conscious effort e.g. driving.
- Rule based: where the activities of a task must be carried out in a certain order. Often these types appear in instructions as check sheets which the operator must follow to the letter.
- Knowledge based: The operator has to work out from first principles or inferred data analysis what the correct sub-tasks or action should be e.g. mechanic diagnosing a fault on a car.

Monitoring or supervisory tasks are sometimes classified separately for special consideration.

The performance shaping factors listed above have different effects on the different types of tasks that people carry out. For example interruption can be the most damaging performance shaping factor for skill based tasks whereas time might be the most damaging to knowledge based tasks.

There is also a need to consider the type of error that can occur during a task. Errors can be broadly identified as:

- error of “Omission” – failure to do something;
- error of “Commission” – making a mistake whilst doing something.

By combining the performance shaping factors with the types of task and the type’s likelihood of certain errors it is possible to create a spectrum of human error potential. The process of human reliability assessment (HRA) uses systematic techniques to (qualitative and/or quantitative) to assess the risk potential of an error occurring. The probabilities that are generated are used to suggest and develop control measures that could moderate the potential of errors occurring.

In nuclear chemical plant design and operation the reliability of operators and management systems are taken into account in considering fault scenarios within safety cases and design assessments. Historical data can also be used to set useful data points which can take account of specific training or working practices. The use of such techniques can establish which operations and activities are most sensitive to human error. Improvements can then be identified to strengthen procedures and improve compliance leading to increased safety assurance [6].

6.4 Ergonomics

Recently ergonomics has developed to encompass not only physical attributes such as shape, size and strength but the mental capacity of people too. The focus of ergonomics has also progressed from improving production levels to the maintenance of health and safety within the workplace. The effective use of up to date ergonomics principles will make work safer, healthier and more productive.

In a high hazard environment ergonomics should be considered from the outset of the first design and at every stage during modification, operation, maintenance and eventually as the plant is decommissioned. Within BNFL in order to support this requirement a team of ergonomists are available for ad hoc work such as review of modifications to plant and processes, workstation assessment and task analysis but are also integrated into the formal processes for periodic review of safety cases and design of new plant.

Example of ergonomic consideration might be:

- the design of software;
- the design and layout of control panels;
- the levels of heat, light and noise;
- the design and impact of alarms systems;
- use and relevance of procedures;
- the comfort of personal protective equipment;
- the colour coding and labelling of controls;
- the workstation design.

This can give a more uniform working environment across different types of plants, optimised operator response and general operator health and performance improvements.

6.5 Organisational psychology

Organisational factors have an indisputable influence on the behaviour of groups and individuals. This is underlined by investigations into mass disasters and accidents that quote organisational factors as root causes. But unlike human reliability and ergonomics, the impact of organisational psychology is more difficult to quantify at any one point in time.

This discipline covers a wide area of work that aims to promote a positive culture within the organisation that embraces:

- an appropriate style of leadership;
- a atmosphere of open, continuous and two way communication;
- clear and efficient definition of responsibility, accountability and resources;
- the systematic application of a comprehensive safety management system;
- a positive health and safety culture that promotes reporting;
- consideration of change;
- learning from operational feedback.

Specific techniques such as safety climate surveys can be used as a metric to measure safety culture within specific sites or functional groups [7,8,9]. The findings of such studies then can be used to target improvements in health and safety performance.

7. Effluents

Some of the fuel cycle facilities may pose special safety hazards to the environment because they produce large quantities of effluents or they have the potential to produce highly hazardous effluents. For example, uranium milling and processing generate large quantities of radioactive and chemically toxic effluents that must be stored or disposed of close to the point of generation to avoid large expenses. Similar effluents can be generated by fuel fabrication facilities. Other facilities, such as MOX fuel fabrication plants, reactors, and vitrification facilities have the potential to produce effluents to air and water with high concentrations of fission products and/or transuranium radionuclides that pose risks to members of the public and the environment.

Effluents in the forms of liquid and gases generated in the nuclear fuel cycle facilities must be treated in order to reduce the environmental and health impacts from release. Systems of effluent

treatment could include a ventilation system with an appropriate filtration system to prevent unacceptable dispersion of aerosol substances within the plant or to control the external release of hazardous substance. A liquid recovering system to recycle selected products with appropriate treatment (filtration, distillation, etc.) in place could be incorporated into the design of the facility to minimise the generation of waste material.

The fuel cycle facilities should have a suitable effluent monitoring programme that allows them to measure and monitor the concentrations of radioactive materials in airborne and liquid effluents and to establish that these concentrations are ALARA and in any case below regulatory limits as established by national authority. Airborne effluents from all routine and non-routine operations are usually continuously sampled.

A sample collection and analysis process are in place with analysis methods and frequencies appropriate for the effluent medium and radionuclide being sampled. Representative samples are usually taken at each release point. Normally a system is in place to limit to as low as reasonably practical potential leakage from onsite pools, lagoons, and tanks to ensure that no unplanned release to groundwater, surface water, or soil is occurring. This system includes procedures and facilities for solid and liquid waste handling, storage, and monitoring to ensure safe storage and timely disposition of the material.

8. Environmental considerations

It is recognised that siting has the potential to adversely affect the environment, either directly or indirectly. Direct effects can occur during the preparation or use of the site, as when existing features are altered to make the site suitable for the facility, e.g. vegetation is removed or wetlands are drained so that foundations can be installed or a uranium ore body can be accessed by open pit mining.

Other direct effects include damage to vegetation resulting from the release of toxic substances from a nuclear facility, such as metals contained in effluents and tailing uranium mining and nitrogen oxides and fluoride compounds from uranium processing. The effects may arise indirectly, for example, from the construction of a new road to provide access to a facility, or a dam to provide a source of water, or even by eliminating the habitat of some species which is important to the ecology of the region in which the facility is located.

In certain cases, there is also the potential for significant socio-economic effects from the installation, operation, or decommissioning of nuclear facilities. This is due to such factors as the influx of new populations or changes to employment patterns which result from commissioning or closing down of the nuclear facility.

In many countries, governments have prescribed requirements, typically referred to as environmental assessments, to identify at the planning stage what effects may be produced. On the basis of those findings, a decision is made as to whether a project should be allowed to proceed or what measures should be used to balance adverse and positive effects. The consultation of stakeholders, particularly of neighbouring populations, plays a more and more important role in the decisions.

9. External safety issues

The safe operation of nuclear fuel cycle facilities can be affected by events that occur externally to the building or site. These external hazards can be man-induced or can result from natural phenomena. Hence, to ensure that both site personnel and the general public are adequately protected, fuel cycle facilities are required to be able to cope with reasonably foreseeable events of this type. The designers of new facilities are required to consider the effects of earthquakes, fires and explosions, accidental aircraft crashes, extreme weather conditions, and flooding. The following Section addresses each of these events in turn and gives an indication of the approach and standards adopted by various countries.

9.1 Seismic events

Where the radioactive inventory or the consequences of loss of containment are such that site personnel or the general public would be significantly affected by the damage done to a fuel cycle facility as a result of an earthquake, this plant is seismically qualified to a reference earthquake. The extent of seismic qualification depends upon the type of plant or structure and its required performance. To determine how a plant will respond to a particular seismic event, it is necessary to know the magnitude of the disturbance and to relate the magnitude to the intensity (severity at the site from an event occurring away from the site).

Most countries operating nuclear fuel cycle facilities adopt a deterministic approach to seismic assessment. This approach ideally requires the evaluation of the seismology and geology in the area of the plant in order to determine the relationship between the magnitude or intensity of the event and its frequency of occurrence. Generally, however, one can only calculate probabilities that a given intensity will be exceeded. Once this relationship has been derived the licensee can specify the DBE (guidelines may be issued by the safety authorities). For instance, the use of 10^{-4} probability of exceedance has been widely accepted for determining the DBE in the United Kingdom for modern (post 1980) plants. Designers use this DBE to design the plant and evaluate the safety performance of the plant.

The above approach is used in most countries although there are some national differences in detailed application.

9.2 External fires and explosions

For safe operation, a nuclear fuel cycle facility is either designed to cope with external fires or explosions, or it is shown that the probability of occurrence of an event which would prejudice safety is acceptably low.

The sources of external fires and explosions are such things as the presence of petrochemical installations in the vicinity of the nuclear site, the proximity of forests and of road, rail, and sea routes used for the transport of natural gas and the routing of gas or oil pipelines.

In order to demonstrate that the risks associated with these external hazards are acceptable, the licensee is required to identify all potential sources of hazard and then calculate the likelihood of damage. The radiological consequences of any damage are evaluated and shown to be within acceptance criteria. In the United Kingdom, as in other countries, the licensees are required to carry out a survey of potentially hazardous installations and transport operations concerning hazardous

materials. Typically a radius of 10 km from the installation is chosen for this survey. The risks are evaluated in the case of explosions against over-pressure criteria. Flammable liquids and missiles resulting from explosions are assessed against distance from the plant, and hence their potential for physical damage. Toxic hazards are assessed against specific gas concentrations.

If the probability of a fire or explosion causing damage to a nuclear facility is above acceptable limits, then design measures will need to be taken to limit the damage and hence radioactive release. If the probability is calculated to be sufficiently low, then no design measure will be required. For operating plants the hazard posed by external factors is monitored throughout the lifetime of the plant. The construction of facilities adjacent to a nuclear site that could prejudice the safety of the plants of this site is usually controlled via land-use planning requirements.

9.3 *Accidental aircraft crash*

An aircraft accidentally crashing onto a nuclear facility represents a man-induced external hazard, and the risks associated with this type of incident are required to be evaluated. The approach used to evaluate this hazard is similar in most countries. The potential for accidental aircraft crash is evaluated for the site for commercial aircrafts, general aviation and military jets. In the United Kingdom and France accidental aircraft crash statistics are used to determine the crash probability in the vicinity of the nuclear site; the probability of impact onto a nuclear facility is then calculated by evaluating the vulnerable impact area. This probability is compared with the criterion for a major release of radioactivity of 10^{-7} per year. If the calculated impact probability is less than this, no specific measures are required for accidental aircraft crash. However if the impact probability is greater than 10^{-7} per year in United Kingdom (same value for one family of aircraft in France), the designer is required to introduce measures to mitigate the consequences of such an event so that radiological releases are within acceptable criteria. In evaluating the consequences of impact or the adequacy of the design to resist aircraft impact, realistic accidental crash scenarios are often considered. These require knowledge of such factors as the angle of impact (normally taken into consideration in France) and the potential for fire and explosion resulting from the aviation fuel.

To minimise the potential for aircraft impact, aircraft are excluded from airspace above nuclear fuel cycle facilities; for example, in the United Kingdom and in France there is an overflying restriction zone.

When considering the probabilities of accidental aircraft crash the situations differ from one country to another. For example, French military aircraft crashes generally occur close to air bases, whereas in the United Kingdom such crashes are more widely distributed across the country, not necessarily only in training areas. It is also important to take site-specific circumstances into account. For example, at Cadarache research centre in France, flights of forest fire-fighting aircraft are considered.

When it comes to translating an aircraft impact into a given loading on the structure, Germany is the only country to have developed a specific loading function. This approximates the loading curve believed to result from a Phantom military aircraft flying at approximately 215 m/s. The Japanese Rokkasho Reprocessing Plant also considers the Phantom as a load case.

It was noted that fire could not in general be ruled out following an aircraft crash (most crashes are followed by fire), and that this sometimes leads to a specific fire protection requirement. For example, in a Belgian assessment 5 t of aircraft fuel burning for three minutes is taken as a typical case.

It is felt that these measures, when taken, provide not only accidental aircraft crash protection but a form of umbrella protection against a variety of other hazards such as a terrorist attack. Given a defined aircraft threat in terms of either a specified plane or loading, at least approximate methods are available to assess the effects on a structure. Germany, the United Kingdom, and the United States use specific calculation codes or formulas.

9.4 *Extreme weather conditions*

Extreme weather conditions can cause an external hazard to the safe operation of a fuel cycle facility, either by directly affecting the integrity of the structure or through indirect effects such as bringing down power lines, or affecting cooling water supplies. The general approach is to use a deterministic design basis value for the condition and assess the impact of such an event on the operational capability of the plant. In the United Kingdom, for example, the design basis values for assessment are chosen as those associated with the 10 000 year return period event.

Historical data can be challenged by new events and design basis values have to be updated in this case.

The impact and hence the design provisions vary depending upon the type of hazard. For example, extreme wind loadings are associated with rapid structural loading, and thus design provisions are required in the same way as other potential rapid loading events such as earthquakes. However, the effects of extreme precipitation or extreme temperatures would take time to develop and hence there is time for operational actions to be taken to limit the consequences of the event.

Typically, the extreme weather conditions used to design and/or evaluate fuel cycle facility response are wind loadings, tornadoes, rainfall, snowfall, extreme temperatures, and flooding.

9.4.1 *Tornadoes*

Protection against tornadoes depends on the meteorological conditions of the area where the facility is installed. Since strong tornadoes occur in some areas of the United States, it has special regulations with regard to tornadoes. The country is subdivided into three distinct sections with maximum wind speeds of 384, 480, and 576 km/h. These extreme wind speeds have only a locally devastating effect but require special construction designs. Experimental evidence has been provided to show that steep pressure changes may damage the integrity of ventilation systems that have not been designed to withstand such conditions. The US Federal Code, 10 CFR Part 50, prescribes the design criteria with which nuclear facilities must comply. Although hurricanes with wind speeds of 160 km/h have great climatic influence, they do not provide an additional threat to conventionally well-designed buildings.

In the United States, all types of extreme weather conditions are considered by the designers of higher potential risk non-reactor fuel facilities, such as reprocessing plants or plutonium recycle plants, depending upon the location in the country. Tornadoes are frequent in the Midwest and hurricanes can be severe along the eastern coastline. Both wind phenomena are capable of lifting and propelling objects such as automobiles or telephone poles. These missiles are taken into consideration during the design stage, both for their initial impacts and possible secondary fragments spalled from concrete walls or other types of momentum transfer.

Analytical methods have been developed to determine the effects of sudden pressure changes on facilities, primarily as connected with tornadoes. A high-pressure differential can create a significant external or internal force on building walls, as well as create high-velocity airflows in either forward or reverse direction. Some analyses have coupled earthquake damage followed by relatively strong attendant winds in order to gain a perspective of design resistance to such extreme events. The analytical techniques have been used to estimate both the quantities and location of radioactive material movement through and from processing cells. Maximum credible doses to individuals, both on the plant site and beyond its controlled boundaries, have been calculated by such techniques.

Maximum water flooding conditions connected with large storms have also been estimated.

The design against earthquakes is generally considered as an umbrella protection for most types of external hazards.

9.4.2 *Extreme temperatures*

The duration of extreme temperatures has to be considered in order to assess the effects of freezing, for example, on secondary equipment (cooling circuits) of fuel cycle plants, as well as the effect of high temperatures on the efficiency of cooling systems.

9.4.3 *Snow*

The occurrence of snow and its effects have to be taken into account in the safety design and analysis, as well for structural and system effects as for staffing and access issues (including the off site access for the staff).

9.4.4 *Floods*

Floods have to be taken into account when designing a facility. Two approaches to cope with this type of hazard have been proposed:

- some countries take into account the highest flood levels historically recorded and erect the nuclear facilities on specific locations or at sufficient elevation to avoid major damage;
- other countries, where dams are widespread and built up-stream of potential or existing nuclear sites, take into consideration this hazard by designing the buildings in such a manner that they withstand the water wave released from the collapsing dam.

10. **References**

- [1] SCSIN (1985), *Protection contre un incendie*, Règle fondamentale de Sûreté, No. 1.4.a, Chapter 4A, February 1985.
- [2] WANO (2002), *Principles for Excellence in Human Performance*, GL 2002-02.
- [3] HSE (2003), *Reducing Error and Influencing Behaviour*, HSG 48, May 2003.

- [4] HSE (1994), *Third Report Organising for Safety*, ACSNI study group on human factors, 31 December 1994.
- [5] Reason, J.T., Duncan and Leplat (1987), *A Framework for Classifying Errors in New Technology and Human Error*, Wiley Publications.
- [6] HSE (1995), *Improving Compliance with safety procedures: reducing industrial violations*.
- [7] IAEA (1991), *Safety culture*, Safety Series No. 75, INSAG-4, Vienna.
- [8] IAEA (2002), *Safety Culture in Nuclear Installations*, TECDOC-1329, Vienna.
- [9] IAEA (2002), *Key Practical Issues in Strengthening Safety Culture*, INSAG-15, Vienna.

Chapter 5

SAFETY OF THE FRONT END OF THE FUEL CYCLE

1. Uranium mining and milling

The mining and milling of uranium do not have the same level of potential safety problems that are associated with operation of nuclear reactors and other fuel cycle facilities. The uranium mines do have the same safety and environmental issues as other mines in addition to the precautions required to deal with the radioactivity of the ore. Uranium mines are more publicly scrutinised because of these radiation issues. The results are that the safety, radiation, and environment programmes are highly successful.

There have been over 40 years of experience in successfully applying international radiation safety regulations at uranium mines. The ICRP has established recommended standards of protection. Risk factors were determined from low levels of radiation [1]. The scientific evidence does not indicate any cancer risk or immediate effects at doses below 20 mSv/y (millisievert per year). The ICRP recommended levels of effective dose are 1 mSv/y for the general public and 20 mSv/y for the radiation workers averaged over 5 years, with no individual year above 50 mSv. This is in addition to the background and medical exposures. Most countries have adopted these standards, including the two largest producers Australia and Canada. These standards are based on the following principles:

- justification: no practice involving exposure to radiation should be adopted unless it produces a net benefit to those exposed or to society in general;
- optimisation: radiation doses and risks should be kept as low as is reasonably achievable (ALARA), economic and social factors being taken into account;
- limitation: the exposure of individuals should be subject to dose or risk limits above which the radiation risk would be deemed unacceptable.

Mining has been successful at meeting these principles and standards. Radiation dose records show that the maximum doses are about half of the annual exposure limit of 20 mSv/y compared to natural doses in some areas of the world of up to 50 mSv/y. The mine and milling facilities are designed with the ICRP principles in mind, particularly ALARA. The proposals are closely reviewed by the government regulatory agencies to ensure the principles are adhered to. Regular reviews and inspections occur during construction, operation, and decommissioning to ensure the accepted plans are implemented and that the high standards are maintained in radiation protection. Public input is part of the process.

The three main sources of radiation exposure are radioactive dusts that are breathed in, gamma radiation from the ore that irradiates the body, and radon gas that is breathed in. Strict hygiene is practiced in the mines and process areas to prevent ingestion of uranium or uranium oxide. This includes restricted eating areas, washing prior to eating, regular washing of work clothes, and a urine sampling programme to monitor any ingestion.

The dusts are generated by drilling, crushing, and dry conditions where fine particles exist. The drilling is now done wet with the drill cuttings contained by wet scrubbers or some other form of containment to minimise contamination. Crushing is either done wet or with hooding and exhaust ventilation to contain the dust. Fines in areas such as process or roadways are kept to a minimum with prompt cleanup and keeping areas wet. Equipment such as scoop trams, trucks, and surface loaders has enclosed cabs with filtered air systems. Dust masks with the appropriate dust filter are used where necessary. Mines have area and personnel dust samplers to monitor the success of the programmes and where improvements are necessary.

Gamma radiation protection follows the three principles of shielding, time, and distance. The main goal is to keep the worker away from the source of the gamma radiation. This is achieved by doing the access and mining in the waste rock, where possible, particularly in higher grade underground mines. This usually involves using a non-access type of mining method that has the extraction chamber and drilling chambers in the waste rock. Blast hole stoping is a method conducive to this. The ore drilling is done from a drift in waste rock above or to the side of the ore zone to be extracted. The extraction is done at the bottom of the stope through draw points in waste rock such as at Rabbit Lake. The high grade McArthur River property uses this principle as well.

The raise bore mining method is schematically shown on Figure 5.1. The top photo shows the raise bore. The raise bore first drills a pilot hole downwards from a waste rock drift through the ore zone to the extraction chamber in waste rock. The drilling is done wet with water that carries the drill cuttings by pipes to the process. The 3 m diameter reamer head is then attached and pulled back up through the ore zone. The raise cuttings are collected through a chute into a remote controlled scoop tram for transport to the process.

Figure 5.1. Ore extraction – Raise bore method

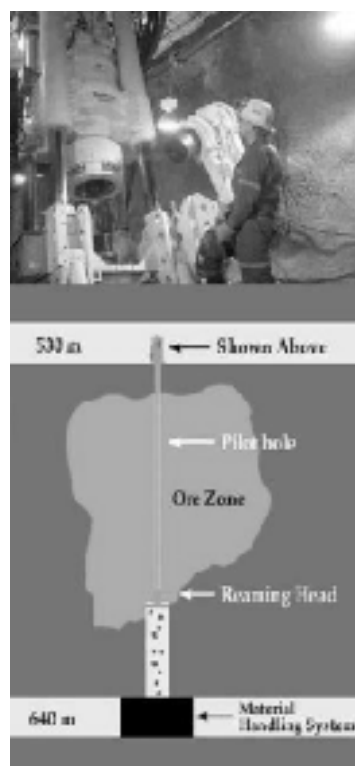

Shielding can also be done in mining by concreting or shotcreting over the gamma source.

Cluff Lake Mine uses shotcrete in their under hand cut and fill method. The ore is less than 1% and allows an entry mining method. The shotcrete and concreted backfill provide sufficient shielding to mine the ore safely. The tanks and pipes are designed with sufficient shielding thickness of steel and concrete to reduce the gamma radiation to acceptable levels. Access to process and mining areas, particularly during operation, are also controlled to minimise potential exposure times. Direct reading dosimeters are used to help minimise worker exposures, to increase the awareness of the workers to potential radiation sources, and to aid in the expedition of corrective measures.

Radon gas inhalation is a potential hazard as it decays to the solid radon daughter which is significantly alpha radioactive. The radon comes from mine water that is rich with radon directly from the ore or from the uranium ore body. This is usually not a problem in open pits. However, this can be a serious problem in underground mines if the appropriate controls, ventilation, and instrumentation are not effectively in place. Radon gas is controlled by preventing radon-bearing water from entering the underground workplace by designing the openings in dry areas. If this is not feasible, then grouting the cracks in the surrounding rock or applying an impervious layer to contain the water can reduce the radon. Radon-rich water can be dealt with effectively by containment in air tight enclosures or enclosures that are exhaust ventilated to remove the contaminated air to an exhaust pipe or airway. Where there are potential sources of radon in the workplace, single pass fresh air ventilation exhausting directly to a restricted exhaust way keeps the worker in fresh air. It is important to keep mechanical air control devices in fresh air so that repairs can be done in fresh air. In areas that have potential for radon, instruments that can continuously monitor the radon level can alert the workers to any changes so that corrections can be implemented to maintain the safe working conditions. The instrument displays should be located so that all workers in the area, as well as those entering the area, can be aware of the conditions. These methods effectively prevent worker exposures from radon.

Environmental safety issues are basically similar to other mines with an additional factor, radioactive contamination. The waste products are the waste rock, the tailings, and the contaminated water from mining or the process. The waste rock usually has three categories: uranium bearing but uneconomical, acid generating, or barren. The first two require containment to prevent water runoff to the environment. Approved designs for construction, operation and decommissioning are required. Barren waste rock can be stockpiled, or used for fill and roadways. The tailings must be stored in a manner to minimise the potential contamination of the water table as well as the generation of radioactive dusts. Historically, mines have used natural depressions or constructed tailings impoundments. There have been problems with low-level radioactive dust if the impoundments are not covered quickly in decommissioning.

The current thinking is to dispose of the tailings in water-tight surface containments designed to eliminate the pore water pressure problem or submerge them in highly impervious mined out pits constructed to allow the groundwater to flow around the tailings as shown in Figure 5.2.

Figure 5.2. Tailings management facility at Key Lake
 (Source: Cameco – Canada)

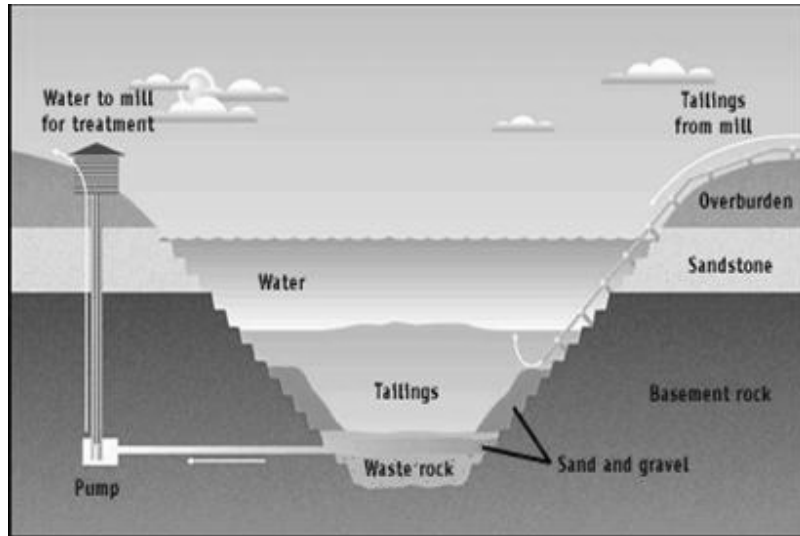

Contaminated water is water that has been in contact with the ore or has been contaminated in the process. The excess water that cannot be used in the mine or process is treated to meet the local government discharge standards. The contaminated water from a uranium mine also has radium that is removed usually with barium.

In situ leach process facilities have monitoring wells around the periphery of the mining area to ensure there is no contamination to the surrounding groundwater (Figure 5.3). After the mining is complete, the mining area is restored to the baseline water quality before decommissioning, which includes the sealing of the wells and removal of all facilities. Revegetation of the area is done as a final step.

Figure 5.3. Idealised *in situ* leach process in section at Crow Butte site
 (Source: Cameco – Canada)

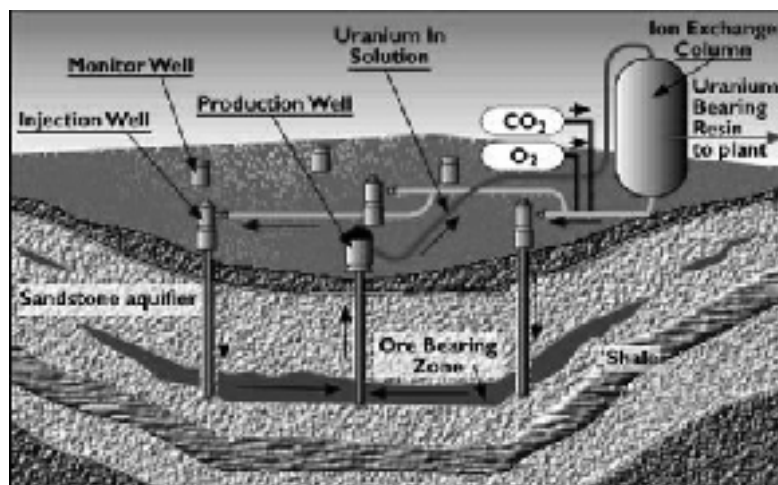

2. Uranium refining and conversion

The mining and milling processes produce uranium ore concentrate (UOC), sometimes known as yellowcake, which, chemically, is impure U_3O_8 or uranium diuranate. This has to undergo refinement, in processes described in Section 2-2, to convert it to nuclear-purity uranium hexafluoride, tetrafluoride or uranium metal, which are then processed to uranium oxide, or uranium metal, fuel respectively.

The potential hazards to workers and the public from the refining stages are similar in many ways, but there are two important differences. These are:

- The solvent extraction stage in the mining/milling process removes most of the radioactive daughter products of uranium, present in secular equilibrium with natural uranium. This means that operator and public doses due to short-lived beta radiation are much lower, and it effectively eliminates the impact of the daughter product radon;
- The most significant potential hazard is chemical, not radiological, arising from the handling of bulk quantities of hydrogen fluoride (HF) and the fact that a release of UF_6 (hex) would also generate HF on contact with moisture in the atmosphere.

The early process for refining in the United Kingdom, involving conversion of pitchblende ore, placed emphasis on complete changes of protective clothing, radiation monitoring badges, and frequent medical checks to protect the operators [2]. The substitution of UOC for pitchblende, although significantly reducing the hazard, did not in any way detract from the rigor of radiological protection that has continued, with incorporation of many improvements, to the present day. Some of these are described subsequently.

Emergency plans, for workers, on-site facilities, and for the general public, focus on dealing with the potential chemical hazard. These plans are publicly available documents, available from the refining utilities, and lodged in United Kingdom in places such as public libraries [3].

2.1 Radiological protection

The main potential radiological hazards in refining arise from the possibility of inhalation or ingestion of compounds of uranium, leading to internal dose. The potential for external dose is generally low except where the process leads to concentration of daughter products of uranium that have grown back in after the mining/milling stage. Regardless of the magnitude of the dose, however, the United Kingdom operators implement a continuing system of dose reduction, on the ALARP principle, wherever improvements can be identified and made. One of the stages at which such accumulation of daughter products can occur is the casting of uranium billet into crude rods for uranium fuel fabrication. Although not directly a part of the refining process, casting in the United Kingdom is carried out in the same building, and by the same workforce, as the preceding production of uranium from uranium tetrafluoride. For this reason, and to illustrate the general principles of dose reduction and management that are used, it is useful to consider the measures taken at the casting stage. A combination of capital investment in engineered dose reduction improvements and many other solutions stemming from joint management/workforce suggestions and initiatives, had resulted in a lowering of average dose (sum of internal and external) from about 18 mSv/y (1986) to about 7 mSv/y (1990) [4,5]. Since that time, many further workforce and management initiatives have been put in place with the effect that the average dose of the (now) combined uranium production and casting stages has been reduced to about 3 mSv per year [6,7]. Although operator doses at the UOC refining stages have always been generally at the lower end of these ranges (about 1-2 mSv/y in

modern times), the same principles of dose reduction have been, and continue to be, employed wherever practicable. In France, casting is carried out in separate plants but comparable general principles of dose reduction and management are employed in refining plants, where the average individual dose (including internal dose) is about 2 mSv/y.

The main thrust of dose management and reduction at UOC refining stages has, for many years, been in the area of minimisation of internal dose from the inhalation or ingestion of uranic powders such as UOC, UO_3 , UO_2 , and UF_4 . This is achieved firstly by aiming to reduce contact by personnel with these compounds by engineered methods; then to contain all operations with potential for generating airborne contamination inside enclosures equipped with air extraction and to ensure that operators engaged in such operations wear respiratory protection, which is also mandatory for some other non-enclosed operations. The change from fluidised beds to rotary kilns, for production of UF_4 , in the late 1970s significantly reduced the degree of operator contact with process materials at this stage and was an important landmark in this respect. This principle of containment, used for many years, and now augmented by incorporation of operator entry lock chambers in which powder can be washed or vacuumed off protective clothing, has proved very successful in reducing operator internal dose uptake. This success is demonstrated by reference to actual operator doses which now average around 1.0 mSv/y (or less, sum of internal and external) against the statutory limit of 50 mSv/y [8] and are summarised in Section 12-1.

All of this is underpinned by a sophisticated system of dose monitoring, recording, and follow up consisting of the following main features [9,10]:

- radiation film badges for operators (these can be augmented by other types of dosimeter as appropriate) to assess external dose;
- static air samplers positioned according to the outcome of comprehensive studies of operations and likely contamination levels (these can be augmented by operator-personal samplers as appropriate) which, combined with operator occupancy, are used to assess internal dose;
- urinalysis;
- whole body monitoring.

Though rare, all cases of unusual dose are rigorously investigated. Finlayson [11] describes how this is done.

All other refining companies, in other countries, use similar procedures in principle.

2.2 *Conventional safety*

The production of hex has been carried out since the early 1940s in the United States, since 1952 in the United Kingdom and France, and since 1969 in Canada. The design and operation of the facilities in this part of the cycle require that not only are radiological concerns satisfactorily addressed, but also that the main processing chemicals, HF, fluorine, and others, are safely handled. In fact, the primary concern from a possible major emergency viewpoint arises from the handling of these materials, so plans for dealing with such situations are based thereon. These are discussed below.

The CSNI Specialist Meeting [12] on the safety problems associated with the handling and storage of hex, held in Boekelo, concluded that the existing processes for refining UOC and conversion to hex gave rise to no significant radiological hazards, and that the safety problems were essentially those of a conventional chemical industry dealing with toxic chemicals. That conclusion

has stood the test of time and remains true to this day. However, adequate precautions are necessary and are implemented to protect workers from radiation exposure and the inhalation of uranic dust, as described above. This is further exemplified by the need to protect against radiation from flame reactor operations in some countries outside the United Kingdom.

Uranium hexafluoride at ambient temperature (at which it is stored) is a colourless, crystalline solid with a low, but significant, vapour pressure. When heated, for example to transfer it from vessel to vessel, the crystals sublime without melting, giving a vapour pressure of 760 mm Hg at about 56°C. At higher temperatures, melting, accompanied by a substantial increase in specific volume, occurs. It is the handling of hex, in the vapour and liquid states, that represents the greatest potential for high release rates in the event of a failure of containment.

Hex is a very reactive substance. It reacts with water, most organic compounds, and with many metals. However, it does not react with oxygen, nitrogen, or dry air. Its reactivity with moisture in air is what leads to the principal hazard if it is released to atmosphere. Two toxic substances, hydrogen fluoride and uranyl fluoride (UO₂F₂), are produced according to the equation:

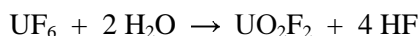

With gaseous hex, this reaction proceeds rapidly, liberating heat and accompanied by a substantial volume increase at atmospheric pressure. Emergency plans are structured to deal with this situation also.

Hex is stored in cylinders containing a maximum of 12 t, which is the limiting upper quantity that could be released from one cylinder. However, temporary in-process storage of hex in plant condensers could result in accidental release of a larger amount. Also, accidents involving more than one cylinder could occur, for example during transport or storage. At these stages, though, it must be recognised that the hex is in solid form and therefore much less likely to be released than when it is being produced, or transferred, in the liquid or vapour phases. The possibility of fire, raising the temperature sufficiently to vaporise hex, has to be taken into account, as do more remote scenarios such as accidental plane crashes onto a hex facility. These are all addressed in emergency plans that conclude that the main hazard is from chemical toxicity rather than immediate radiological hazard.

Some countries have chosen to reduce the risk associated with the storage of hex by converting depleted UF₆ to UF₄, a powder which can be stored more safely and at less cost. Decisions of this nature will be made after taking due consideration of potential risks from both situations on the ALARA principle. Depleted means either “pile depleted” that is having been used in a reactor, or “tails depleted”, being the depleted fraction from an enrichment process. In France, both pile and tails depleted UF₆ are converted into U₃O₈ powder, which is also a very stable form suitable for safe storage.

As far as actual experience is concerned, relatively few accidental releases of substantial quantities of hex have occurred. A review of those that have occurred is presented in Section 12-3 and discussed further in [12,13,14].

The main chemical hazard in the production of hex arises from the use of HF at the UF₄ and UF₆ production stages. Fluorine, though certainly highly toxic and damaging to human tissue, presents less of a hazard since its production can be stopped fairly quickly, for example, in the event of a release, and it is not stored. The use of the highly reactive, and explosive, chlorine trifluoride for hex production ceased many years ago. In the United Kingdom, the risk from HF has been reduced dramatically since the mid 1990s by significantly lowering the onsite inventory in favour of direct

feeding to user plants, and by the introduction of larger supply tankers which allow lower numbers of deliveries and fewer connecting/disconnecting operations. Despite this, the most stringent controls of, and procedures for, handling of this very toxic substance are still employed (and always have been). These are based on selection of correct materials for plant and equipment, containment, workforce protection and education, and regularly rehearsed emergency plans for all stages from local plant to offsite areas.

Other potential large-scale hazards can include, depending on the processes used, magnesium, hydrogen, and nitric acid. Magnesium is stored in a bonded store, with fire and explosion prevention measures, and is subject to similar protection measures during use in the process. Hydrogen inventory is minimised by a “just in time” supply system and its usage takes advantage of all up-to-date safety systems and procedures. Nitric acid is still stored and used in bulk quantities, but the inherent risk associated with it is very much less than that of HF. Nevertheless, its use is still subject to the same standards of care and containment.

Very few fatal, or other truly serious, accidents have occurred in the history of UOC to hex refinement. However, there is an incidence of the kind of accident that can occur on any type of chemical plant – falls, chemical burns, hot and cold burns, accidents due to electricity, release of stored energy, or failure to wear protective clothing, as well as many other types. Refining operators have always paid particular attention to this type of accident but, toward the end of the 1980s, the United Kingdom operator felt that its standards in this area did not match those for radiological protection. Accordingly, it embarked on a programme aimed at reducing the incidence of this type of accident. There were many reasons why this was necessary, and these, together with the results up to the mid-1990s, have been described in [15]. The rate of accidents that resulted in a person having to lose more than three consecutive days work had, by then, been more than halved. In the United Kingdom, this is a legally reportable measure of accident prevention performance. Since that time, the programme has moved forward based on systems for improvement of safety culture and personal safe behaviour to the extent that this operator now ranks with the best chemical facility operator in the world ([8] and Chapter 12).

2.3 *Emergency plans*

As stated above, these centre on the need to respond to toxic chemical releases though, on multifunctional sites such as the United Kingdom one, there is also an element related to action in the event of an uncontrolled nuclear reaction (a criticality incident) [16,17]. In the United Kingdom, as in other countries, the emergency plan is a formal requirement of the licence to operate [18]. It covers local plant on-site and off-site emergency scenarios and a key feature is the requirement to demonstrate to the regulator the effectiveness of the plan by means of scheduled exercises at all levels.

More recent legislation, although aimed primarily at conventional chemical plants, places additional commitments on nuclear chemical plants [19]. In addition, application of the new Radiation Emergency Preparedness and Public Information Regulations 2000, has resulted in a slight extension of the emergency planning distance for sheltering from radiation as part of the overall response [20].

2.4 *Safety management and assessment*

The United Kingdom refining operator implements a structured and comprehensive safety management and assessment system which covers requirements for existing and future plants, and for plants that have been shut down for decommissioning. It is based on a process of categorisation of a

project's safety significance followed by a rigorous assessment of safety implications and needs, the depth of which increases according to the safety significance. All projects, from very minor modifications to existing processes, up to the most major new projects, are covered by the system. All internationally recognised techniques for this kind of work are used and assessments are subject to audit and independent peer review. Full details of the system in use up to the mid-1990s were presented in [21]. Since that time, this operator has introduced a number of further improvements to the way in which it prepares its safety cases. The most significant of these is the Continued Operation Safety Report (COSR) for existing plants. The purpose of the COSR is to summarise the safety arguments and to highlight the main systems (engineering and procedural) that ensure that a plant (or other facility) remains safe. It does this in a simpler format, with a greater emphasis on continued safety of plant engineering functions, than did its predecessors [22].

2.5 Waste management and environmental monitoring

The wet process for refining UOC includes a solvent extraction stage in which remaining impurities in the UOC are separated from the uranium. The radioactive component of these impurities consists of alpha active ^{230}Th and ^{232}Th isotopes, with beta active ^{234}Th and ^{234}Pa arising in an aqueous waste stream known as raffinate. It is accepted practice to dispose of this raffinate to the tidal waters of a river estuary because of its very low environmental impact. In the United Kingdom, this has been carried out for many years under the terms of an authorisation granted by the relevant regulatory authority, currently the Environment Agency [23,24]. The operator carries out a wide-ranging programme of environmental monitoring (which is a combination of a Statutory Environmental Monitoring Programme and additional voluntary work) in order to quantitatively determine the impact of this and other disposals and publishes the results of this programme annually [24]. This shows that the radiation dose received, predominantly from refining operations on this site, to the very small numbers of persons most exposed, is of the order of 10 mSv/y. To other people, it is very much less than this. These results are summarised in Sections 12-1 and 12-2. Their significance can be gauged from the fact that average exposure to the sum of natural radiation, and radiation for medical purposes, in the United Kingdom is about 2 600 μSv per person, with much higher figures than this in some parts of the country [25].

Discharges of airborne radioactivity, disposals of solid waste, and direct radiation are all also measured and their effects estimated. They result in a lower impact than that of liquid disposals.

A number of independent organisations also monitor the impact of these disposals and predominant amongst these is the regulatory authority, the Environment Agency [26]. Although not all of the authority's determinations of radioactivity levels agree with those of the operator, the majority does, and the differences can, in most cases, be explained by decay of short-lived beta activity or different methods of analysis. They are not significant in terms of impact and there is general agreement that arrangements in place to monitor radioactivity levels are effective.

The UOC used for refining also contains a range of non-radioactive impurities which are separated and discharged in the raffinate along with the radioactive component. Details of these discharges are published together with those of the radioactive species [24].

During 1993, the United Kingdom operator, at the request of the regulatory authority, carried out a Best Practicable Environmental Option (BPEO) study on its liquid radioactive disposals [27]. A BPEO study considers all parts of the environment so that an assessment of impact on the environment as a whole, rather than just one part of it, can be made. A large number of possible options for treatment or discharge of the liquid waste stream were considered and assessed and the outcome was

that the only change that should be made was to set out to select for refinement those UOCs with relatively low thorium content. Since then, this has been put into practice with the effect of reducing ^{230}Th and ^{232}Th discharges to the nearby tidal river. A review of this study is expected to conclude that this practice should continue.

3. Uranium enrichment

Most nuclear power plants use enriched uranium to improve reactor power density, increase operating time between refuelling, reduce spent fuel quantities, and allow the use of light (normal) water for the moderator and coolant. Enrichment uses physicochemical methods to increase the concentration of the fissile uranium isotope (^{235}U) from its naturally occurring level of about 0.71% to the 3-5% range for power reactor use. A DU stream containing less than natural assay uranium (typically 0.25-0.4% ^{235}U , depending mainly on economic conditions) is also generated as a by-product and is sometimes referred to as uranium tails. The enrichment plants are large facilities because of the small differences in physicochemical properties between ^{235}U and the other uranium isotopes (primarily ^{238}U) that require many unitary enrichment stages. A listing of the large-scale, operating enrichment facilities is given in Appendix 1. These are based on GD and GC technologies. Advanced GC and laser-based processes are also being investigated in active R&D programmes.

3.1 Separative work unit (SWU) – A metric for enrichment plants

The concept of separative work is used to understand and compare the various enrichment processes. Separative work is a quantitative measure of the amount of isotope separation obtained by a separator. A separator is a process or device which accomplishes the enrichment of the ^{235}U uranium isotope. For uranium enrichment, separative work is usually expressed in units of kg SWU or simply SWU. A given amount of separative work can significantly enrich a small amount of uranium or slightly enrich a greater amount of uranium. Separative work is proportional to the amount of uranium processed. Separative work increases with the degree of enrichment in ^{235}U in the enriched product (i.e. more work is required to recover more ^{235}U from the same amount of natural uranium) or the depletion of the isotope in the DU tails.

Separative work is defined by the following equation:

$$\text{SWU} = [P \cdot V(x_p) + W \cdot V(x_w) - F \cdot V(x_f)] \cdot T$$

where:

- T = time (usually 1 year);
- P, W, F are product, tails, and feed flow, in kg;
- V(xi) = separation potentials.

The separation potentials are sometimes called value functions, and are defined as:

$$V(x_i) = (2 \cdot x_i - 1) \cdot \ln[x_i / (1 - x_i)]$$

where $x_i = x_f, x_p$, or x_w represent assay levels (enrichment) in the feed, product, and tails streams respectively.

The flow rates can be calculated from:

$$[F/P] = (x_p - x_w)/(x_f - x_w)$$

$$F = P + W$$

For uranium enrichment, a feed material is introduced to the separator and the resulting product is produced with a higher enrichment while the generated depleted stream is produced with a lower enrichment. The uranium enrichment process usually utilises multiple separators arranged in stages to achieve useful amounts of product enrichment. Stages are arranged in series to increase enrichment and in parallel to increase throughput. The assembly is termed a cascade. The assay of the product is the percentage of uranium atoms that are ^{235}U . The process of enrichment increases the assay while the process of depletion decreases the assay. Through a succession of stages, the enrichment of ^{235}U is increased until the assay of ^{235}U reaches the desired level for the particular application. For most commercial applications, the ^{235}U is enriched to something less than 10% ^{235}U (3-5% is typical for nuclear power reactors) and is termed low-enriched uranium (LEU).

Figure 5.4 provides a curve for the feed rate (kilograms of feed for each kilogram of enriched product) and a curve for the SWU factor (SWU per kilogram enriched) as functions of the product enrichment level, for a 0.3% tails assay. Typically, for LEU with about a 3% assay, around 5.5 kg of feed and 4.3 SWU are required per kilogram of product, with a tails assay of 0.2%. With a tails assay of 0.3%, 6.6 kg of feed are needed, with only 3.4 SWU. In contrast, increasing the assay to around 4.5% can require about 10.2 kg of feed and 6.2 SWU per kilogram of product, at a tails assay of 0.3%.

Figure 5.4. Feed rate and SWU relationships

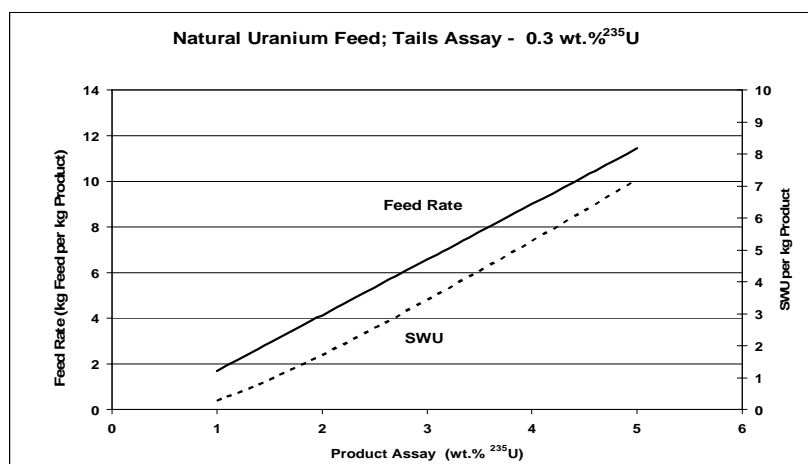

A large commercial nuclear power plant requires 30-35 t of uranium per refuelling outage. Plants on annual cycles use LEU around 3% assay, and plants on longer cycles (18 months) use 4-4.5% assay LEU. These parameters translate into approximately 100 000 to 120 000 SWU per reactor year.

In contrast, some research reactors use HEU fuel. Around 200 SWU are needed to produce 1 kg of 90% HEU (i.e. containing 90% of the ^{235}U isotope) from 200 kg of natural uranium. However, HEU is a small market (most research reactors have been modified to work with 20% assay uranium, for proliferation reasons) and most enrichment facilities are designed for producing LEU for nuclear power production and cannot produce HEU.

Economical and reliable operation of enrichment facilities depends upon balancing facility capital costs (number of stages), feed quantities (tails assays), and operating costs (power and equipment maintenance).

Separative work depends only on the end states and is independent of the type of enrichment process. The separation factor is the ratio of the amount of enrichment achieved to the amount of depletion achieved, and is usually based upon one stage or separator. The separation factor is sometimes referred to as alpha and is intrinsic to a specific process. For processes utilised commercially, the separation factor is approximately independent of the feed assay. Ideally, a separator for an enrichment process would have a high separation factor, a high throughput, and a relatively high ratio of product rate to feed rate.

3.2 Enrichment technologies

A number of different enrichment technologies have been proposed to achieve ²³⁵U enrichment. The principal technologies include GD, GC, laser isotope separation, and electromagnetic isotope separation. Table 5.1 provides a list of uranium enrichment methods and their parameters that have undergone significant testing and/or use. Of these principal technologies, uranium enrichment by the GD and GC technologies have proven to be the most commercially viable alternatives and have been implemented at the plant scale. Enrichment by GC methods is becoming more prevalent.

3.2.1 The gaseous diffusion enrichment process

The GD processes for uranium were first developed in the 1940s. The first successful, large-scale facility was constructed and operated in Oak Ridge, Tennessee, in the United States. Since that time, several plants have been built worldwide. Gaseous diffusion plants (GDPs) have a large floor area under roof; the GDPs in the United States have over 160 ha (400 acres) within the process buildings. In the past decade, several GDPs have been placed into standby operation because of an overabundance of enrichment supply, due in part to the success of the GC technology (discussed later) and the downblending of weapons HEU to reactor-grade LEU.

Table 5.1. Overview of uranium enrichment methods

Method	Working medium or fluid	Approximate number of stages to 5% LEU	Operating mode	Potential hazards with respect to GDPs
Thermal other physical	UF ₆	>1 000	Continuous	Higher
Electromagnetic calutrons	UCl ₄ , U	2-10	Batch	Higher
Gaseous diffusion (GDP)	UF ₆	700	Continuous	[Baseline for comparison]
Gas centrifuge	UF ₆	50-100	Continuous	Slightly lower
AVLIS	U-Fe Metal Alloy	1-5	Batch ¹	Higher
SILEX	UF ₆	1-5 – under development ²	Batch ¹	Slightly lower

1. The AVLIS and SILEX process were developed using a batch operation, however, they have been demonstrated to operate in the continuous mode on a pilot level. Additional work will be required before they can be routinely operated in the continuous mode.

2. Currently, USEC is doing tests at SILEX to determine the separation factor for the process which will allow the calculation of the number of stages required; it is too early to comment on the number of stages required.

The GD process depends on the separation effect from the molecular effusion of gas molecules through a membrane. The gas utilised is uranium hexafluoride. On average, lighter gas molecules travel and diffuse faster than heavier gas molecules. Therefore, the flow through a membrane of the uranium hexafluoride with a ^{235}U atom travels slightly faster than the uranium hexafluoride gas with a ^{238}U atom. As such, the ^{235}U uranium hexafluoride molecules strike the separator barrier more often, and if the barrier is properly engineered, thereby diffuse through the barrier to produce a uranium hexafluoride gas downstream of the barrier which is slightly enriched in ^{235}U uranium hexafluoride. The separation factor is about 1.004 per stage. This is a small value and many successive stages are required to achieve useful enrichment of ^{235}U . For power reactor grade LEU, between 500 and 700 stages in series are needed.

The main components of a GD stage include a large cylindrical vessel that is mounted either horizontally or vertically, which contains the barrier. A compressor compresses the UF_6 gas to a pressure sufficient to create flow through the barrier. The compressors are typically driven by electric motors and the UF_6 gas, once it passes through the barrier, is passed through a heat exchanger to remove the heat of compression prior to being introduced and compressed in the subsequent stage. The compressors require seals to prevent outleakage of UF_6 and inleakage of air. Outleakage would result in contamination of the facility and would pose a hazard both chemically and radiologically to the operating personnel. Inleakage of air must be avoided to preclude the introduction of moisture into the process since the moisture interacting with the UF_6 would produce toxic and corrosive acids. In addition, the introduction of moisture could compromise the safety envelope used to preclude criticality since most diffusion systems rely on moisture exclusion as one of the multiple barriers applied to preclude criticality.

In addition to the major operating systems, GDPs require a mechanism to feed the UF_6 and withdraw the depleted and enriched UF_6 , as well as a means to maintain the desired operating temperatures of the facility. The temperature is maintained by large reservoirs of cooling water which are used to dissipate the waste process heat. The electrical load requirement for GDP facilities is significant.

Diffusion plants are designed for economic reasons to be run continuously for periods of several years at one time. Reliability of process equipment and components is high. From a safety standpoint, too, maintenance should be minimised in all areas of the plant where UF_6 is present and particularly in high-enrichment areas where radiation doses could be significant. Bearing in mind that a diffusion plant comprises both pressure systems and vacuum systems, driven by massive pumps, it is not surprising that the most common problems associated with operation of diffusion plants involve vibrations leading to pump and valve leakages and possibly even failure. Vibration could lead to blade failure, and missiles could sever UF_6 lines and lead to a release into the atmosphere. Figure 5.5 shows the effect of a fire initiated by a metal- UF_6 incident at the Portsmouth plant in the United States (9 December 1998); safety systems activated and plant personnel responded appropriately and contained the incident (summary report is given in Section 12-3). Such a release is by far the greatest threat to operating personnel from enrichment plants. The feed and withdrawal systems contain liquefied UF_6 and represent the greatest potential for offsite impact. However, with many years of operational experience to draw on, potential releases are now much less frequent. Modularisation of diffusion plants can ease on-line maintenance on one isolated module at a time.

Operational experience with diffusion plants has been good. The facility operations have generally been reliable and have performed well with low levels of UF_6 release during normal operations. Since the overall hazard associated with enrichment plants is the toxicological effects of UF_6 , it is of paramount importance that any diffusion plant to have in place a comprehensive leak detection and alarm system. The EURODIF plant in Tricastin, France, and the USEC plant in

Paducah, Kentucky, United States, all have systems for detecting and containing accidental UF_6 releases.

Figure 5.5. Portsmouth cell housing after fire

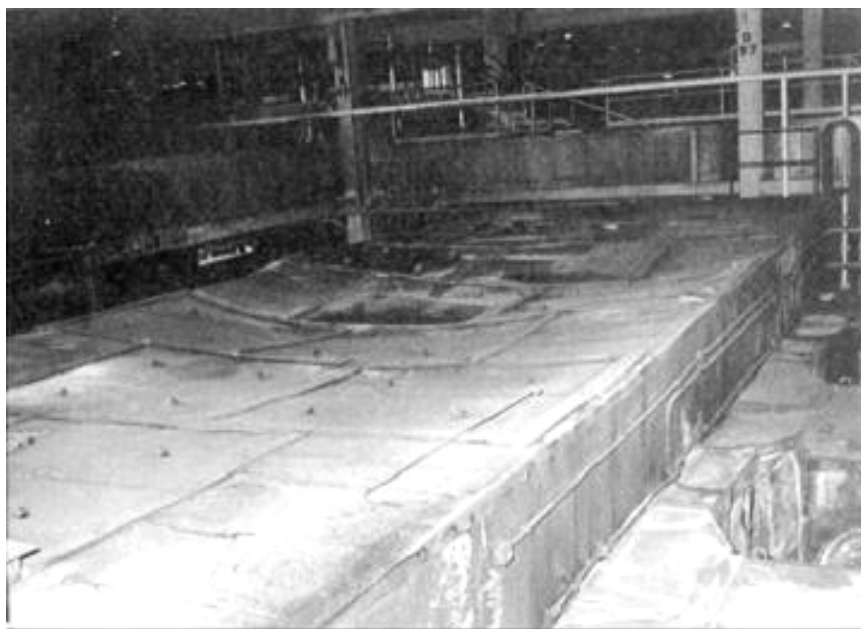

3.2.2 Gas centrifuge enrichment process

The use of centrifugal methods for isotope separation was first discussed in the early 1900s. Uranium enrichment by centrifuges was first discussed in the early 1940s. Working centrifuges of about 1 SWU/machine were developed and tested in the mid-1940s but were overshadowed by the large-scale success of GD, easier to implement in a short time. Experimental work continued on centrifugal methods leading to successful implementation on a large scale in the 1970s.

The gaseous centrifuge (GC) process utilises gaseous UF_6 which is fed into a cylindrical rotor that is spinning at a high rate. The spinning cylinder can be operated at peripheral speeds of several hundred meters per second. The cylinder is evacuated and maintained at low pressures. Figure 5.6 provides a diagram of a gaseous centrifuge machine. The gaseous UF_6 is introduced at the centre of the cylinder. Centrifugal force causes the heavier $^{238}\text{UF}_6$ molecule to move closer to the spinning cylinder wall than the lighter $^{235}\text{UF}_6$ molecule, thus tending to separate the two uranium isotopes. Enriched UF_6 and depleted UF_6 are removed near the ends by special scoops and baffles. Connections are usually made coaxially. Separative efficiency is greatly enhanced by increasing the diameter and length of the cylinder, the peripheral speed of the centrifuge rotor, and by counter current flow induced by internal baffles and thermal gradients. However, these changes also increase the potential hazards and consequences of failures. The tensile strength of the material of construction and resonant vibration frequencies physically limit the size and SWU per machine. Typical machines are 25-30 cm (10-12 ") diameter and 4-6 m (15-20 ft) high. Thus, typical rotational speeds of 20 000 to 25 000 rpm translate into edge velocities of 300-400 m/s (1 000-1 300 ft/s). In the United States, larger machines were used in pilot programmes during the 1970s and early 1980s, and these designs may form the basis for a revised testing and pilot programme.

Figure 5.6. Diagram of a gaseous centrifuge

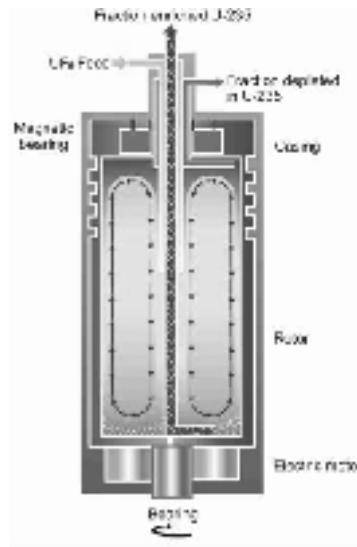

Several large facilities with individual capacities in the MSWU range now exist in Europe and in Japan. Operational experience with centrifuge plants has been good. Plants have generally been very reliable and performed well with low levels of UF_6 release during normal operations. There have been very few and only minor mechanical failures. Furthermore, the electrical consumption of a GC facility is much less (typically more than 20 times) than that of a GDP which generally translates into lower operating costs.

A failure of a GC unit operating at the high operating speed of a GC would generate shrapnel as a result of the destruction of the rotor and other spinning components. Prevention of such a failure is minimised by good design, materials of construction, and assembly of the unit. Research into new constructional materials continues in order to develop safer and higher performance centrifuges. Management of these material stresses is at the heart of the safety of centrifuge plants. Figure 5.7 shows a portion of the many machines in a cascade. A 1-1.5 MSWU/y GC facility might have up to 42 000 machines. At an annual failure rate of 1%, there would be about one machine failure per day. Thus, reliability and failure mitigation are very important, and the facility must accommodate GC machine failure while maintaining safety.

Figure 5.7. Cascade of centrifuges



Gas centrifuge enrichment plants pose hazards associated with handling UF₆ and enriched uranium, as well as hazards that are also found in other industries – particularly those posed by the use of high-speed rotating equipment. The plants are designed to be run continuously for periods in excess of ten years, and reliability and ease of maintenance are of paramount importance both for safety and economic reasons.

3.2.3 *Chemical exchange processes*

Different isotopes affect chemical reaction kinetics. In general, the compound containing the heavier isotope has a slower reaction rate than the lighter isotope. Isotopes of heavier elements also experience lesser relative differences in the reaction rates, resulting in lower separation factors and more cascade-like steps as compared to isotopes of lighter elements. However, this kinetic isotope effect can be used to enrich a heavy element such as uranium. Separation factors are roughly comparable to those of GD and many stages would be required, but this could be balanced by the potential for simpler operating conditions and equipment that exists.

Enrichment by ion exchange is a chemical process which has been studied, and a pilot plant has been successfully tested in Japan, but has not been followed by industrial development. This process does not have any of the associated hazards of high-speed rotating equipment and pressure/vacuum systems. It does not utilise UF₆ and so none of its hazards are present. The criticality problems of handling enriched uranium do apply, however, and these are covered by concentration limits.

The choice of ion exchange medium must also be made carefully, bearing in mind the reagents used in the columns. In particular, the use of nitrates and nitric acid as regeneration agents for the ion exchange system must be carefully monitored to avoid oxidation reactions with organic ion exchange materials. Rapid oxidation can produce explosions and several have occurred due to these ion-exchange resins/nitrate/nitric acid reactions in other installations.

3.2.4 *Laser enrichment*

There are two principal methods of enriching uranium by means of lasers – the atomic route and the molecular route. The atomic route is generally designated as AVLIS. In this route, the working material is uranium metal, usually as an alloy. Uranium metal vapour, at around 3 000°C, is produced by electron-beam heating of a platen in a vacuum chamber. The hot vapour migrates away from the platen. A multi-step photo-ionisation process is performed on the uranium vapour with tunable lasers, resulting in the selective excitation and ionisation of ²³⁵U. The resultant ions are separated and extracted electromagnetically (Figures 5.8 and 5.9). Experimental and pilot testing of AVLIS has demonstrated that reactor level enrichments are achievable in one or two stages, and licensing of a large facility has been considered in the United States. However, significant engineering is needed to improve the reliability of key components and demonstrate the economics of the overall process, including the conversion plants required to integrate an AVLIS plant with existing fuel cycle facilities. Thus, active licensing and larger demonstrations or plants are not currently planned. The research and development of AVLIS has been carried out in the 1980s to the early 2000s in Japan.

In the molecular route, the laser is used to selectively excite one isotopic form of a molecular compound of uranium. Most methods have focused on gaseous UF₆. The compound is used in its vapour state and requires a very powerful laser with an energy flux of some 100 MJ/cm². The gaseous UF₆ has to be cooled to less than 80 K, usually by expansion through a nozzle when mixed with a carrier gas, such as nitrogen. Several processes were under consideration in different countries. In

Japan, Molecular Laser Separation Test programme started in 1988 and continued until 1998. Elemental technologies which include power laser have been developed during this period and there still exist research and development items. At the present time, the most active programme involves the SILEX process in Australia. This uses UF_6 and demonstration testing is planned.

Figure 5.8. The principle of the AVLIS process

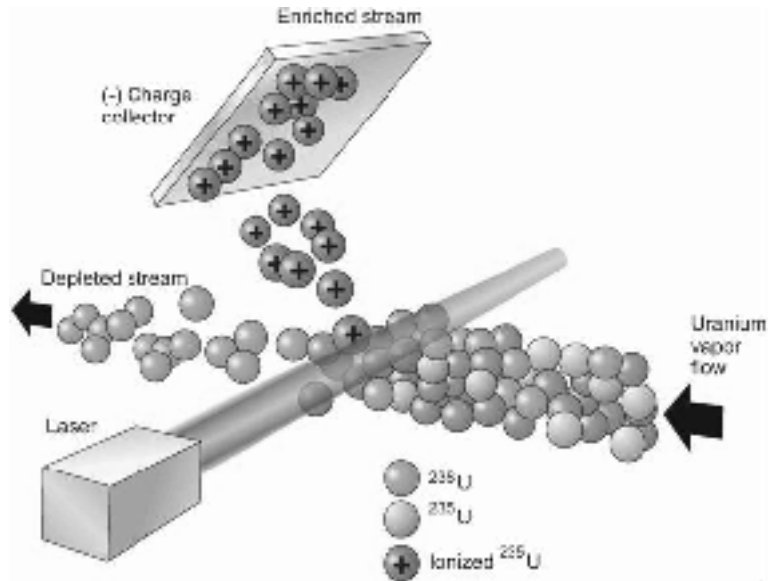
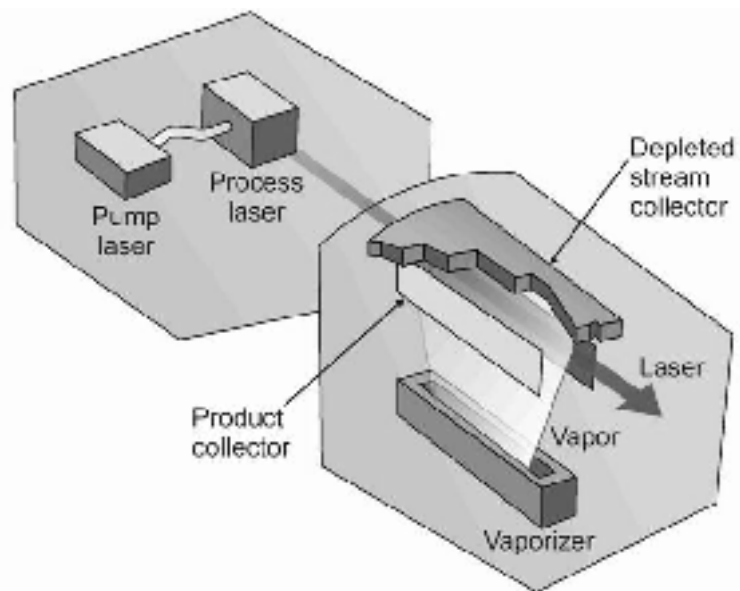

Figure 5.9. The AVLIS system



Conventional hazards associated with the use of high-power lasers (i.e. high voltages and high-power laser beams) are common to both methods. In addition, the possible toxicity of laser dyes and potential fire/explosion hazards associated with high-pressure dye/solvent circuits are taken into account during safety assessments. Containment of high-temperature corrosive uranium vapour poses some metallurgical problems for the vacuum chambers. Uranium accumulation within the vacuum system may require periodic cleanout and decontamination. The vessel will have to be designed to withstand or prevent any reactions and over-pressurisation resulting from contact of hot, liquid uranium with cooling water. An additional problem with the atomic route is the removal of the ^{235}U metal from the collector plates. Finally, AVLIS routes present the potential for dense uranium phases and will require more attention to criticality controls than the GDP and GC processes. Hazards associated with molecular routes include the combination of the corrosive nature of UF_6 and thermo-mechanical constraints which make it difficult to find suitable materials for this route. In addition, heat exchangers and separation/recycle of carrier gases will be necessary.

3.3 *Uranium hexafluoride hazards*

The only uranium compound that is suitable for diffusion, centrifuge, or laser enrichment (by the molecular route), and which is gaseous at reasonably low temperatures (40 to 60°C), is uranium hexafluoride, UF_6 . This substance has the additional advantage that fluorine is mono-isotopic. However, uranium hexafluoride UF_6 or “hex” is a powerful fluorinating agent. It reacts with almost all metals to form metal fluorides. It reacts, often explosively, with organic material to form fluorinated compounds and hydrogen fluoride. With water or almost any level of water vapour, it forms highly corrosive and toxic hydrogen fluoride gas, together with a number of solid and toxic compounds of uranium, oxygen, fluorine, and water of hydration.

Containment of UF_6 is of prime concern, from the point of view of safety, at all stages of the enrichment process. Typical containment materials, such as stainless steel and copper/nickel alloys, retain their long-term integrity by virtue of the immediate formation of a passive, impervious, protective fluoride layer when first contacted by hexafluoride. This layer prevents further corrosion and thinning of the containment.

Processing facilities are designed to a high degree of leak-tightness, particularly where hexafluoride is under reduced pressure. This prevents the ingress of moisture and the formation of solid UO_2F_2 and related compounds which could accumulate and cause blockages. Deposits can also form and require additional monitoring and controls to address criticality safety.

It is those two requirements, i.e. to contain UF_6 within a plant and to keep air and moisture out, which tend to dominate most of the tasks performed in enrichment plants.

UF_6 is supplied to the plant in large containers, typically 12 tHM. At room temperatures UF_6 is solid, and the containers are warmed to generate UF_6 as a gas. Overfilling UF_6 storage containers can lead to rupture due to expansion of UF_6 solid on melting. This has resulted in at least one incident at enrichment plants. At the end of the process the depleted hexafluoride, or tails, is recondensed into containers which may be stored in the open. Having little commercial value as long as FBR are not widely used, stocks of depleted UF_6 have substantially increased over the years, and they can present a hazardous inventory to local populations in the event of a failure of containment accompanied by a source of heat, e.g. an accidental aircraft crash. Storage of the tails as a DU oxide would appear to be more acceptable, longer-term alternative, although there are hazards associated with the conversion. Some countries have chosen this route.

The primary hazard associated with enrichment plants is the toxicological effects of UF₆ should it get into the environment. Therefore, of paramount importance in such plants is a comprehensive leak detection and alarm system.

3.4 Nuclear/radiation hazards

3.4.1 Criticality

Nuclear criticality is always a concern when working with enriched uranium. Criticality is not a major concern in centrifuges themselves because the nuclear inventory in the machines and process piping is insufficient to form a critical mass under all credible scenarios. Criticality is controlled in other areas of the centrifuge plant, and in other enrichment processes, through the use of geometrically safe equipment, control of moderation (or a combination of the two), as well as adherence to administrative control of the process. In view of the size of equipment used in diffusion plants, criticality remains a potential problem. In other enrichment processes, the criticality problems can generally be resolved by engineered means. Criticality assessments, based on an assumed maximum level of enrichment, could be invalidated by an accidental over-enrichment in the process. Structured fault identification techniques such as HAZOP could highlight areas where this is a potential problem.

3.4.2 Recycled uranium

Until recently most enrichment was carried out only on uranium supplies that have not been irradiated in a reactor. However, in some nations, including the United States and France both to a limited extent, progress has been made within existing nuclear fuel cycles to make use of recycled uranium recovered from the reprocessing of spent nuclear fuel.

Recycled uranium differs significantly from natural uranium in five respects:

- ²³²U, which does not occur naturally, is present in recycled uranium. It has a greater specific activity than ²³⁵U, and its decay chain includes a 1.9 y half-life ²²⁸Th alpha-emitter and a number of hard gamma emitters, notably ²⁰⁸Tl. The gamma activity increases with time, reaching a secular equilibrium much greater than natural uranium in about ten years.
- ²³⁴U, a naturally occurring alpha emitter, is also enriched in the fuel before irradiation. It is only partly burnt-out during irradiation. As a result, recycled uranium has a higher alpha activity than natural uranium.
- ²³⁶U, a neutron poison, accumulates. Therefore, a slight increase in the enrichment level is needed in order to compensate for the poison effect.
- Traces of plutonium and neptunium will also contribute to the alpha activity of recycled uranium.
- Traces of fission products (primarily ⁹⁹Tc but others are possible, such as ¹⁰⁶Ru) may contribute to a higher gamma background.

Thus, recycled uranium adds these radiation dose and contamination concerns. The traces of plutonium, neptunium, and fission products can be substantially eliminated by efficient separations at the reprocessing plants. The presence of ²³²U should encourage utilities to recycle material quickly, but economic factors up to now have resulted in little recycling of uranium. Most of the present stockpiles from reprocessing are already at or near equilibrium gamma dose levels.

GC process is better suited than GDP process to enrich recycled uranium, because of the much smaller dimensions of the equipment and consequent smaller hold-up: changes of feed are easier and there is much less contaminated equipment to decommission later on.

4. Fuel fabrication

For nearly five now decades the fabrication of uranium fuel elements for GCR (gas-cooled reactors) and Magnox-reactors, AGR (advanced gas-cooled reactors), LWR and HWR has been an industrial enterprise [28,29]. More than 8 800 tHM uranium oxide fuel elements are manufactured each year in OECD countries (more than 7 500 tHM for LWR and more than 1 100 tHM for CANDU). Also the fabrication of plutonium-containing MOX fuel elements for FBR and thermal reactors has reached industrial maturity on a modest scale of throughput. Very few accidents involving significant radiological hazards and substantial release of radioactive material to the environment have been reported from the nuclear fuel fabrication industry. In addition, no criticality accident has occurred in facilities linked to the commercial generation of electricity. The reasons for this very good safety record are the well-defined processing and handling operations and associated safety procedures, and the chemically stable solid state of most of the radioactive materials involved. The main exceptions to the latter are UF_6 conversion and wet scrap recovery phases which require liquid processing. Potential UF_6 release is also of concern in fuel fabrication plants.

MOX fuels are used for both fast reactors and thermal reactors. Due to the fact that the implementation of FBR in many countries has been postponed or even abandoned, a growing interest in recycling plutonium in LWRs can be observed in some countries. Since most of the plutonium available for thermal recycle in the future will be recovered from LWR spent fuel with increasing burn-up, the design of new planned MOX fuel fabrication facilities has to be based on typical LWR-plutonium isotopic compositions and PuO_2 contents of 3 to 8% in the MOX fuel for LWR.

For the conversion of UF_6 to uranium metal or UO_2 , wet and dry conversion processes are used on a large industrial scale. The subsequent processes of powder production, pellet pressing and sintering, rod fabrication and assembling of fuel elements are fully developed. Completed fuel assemblies are stored at the fabrication plant before being transported to the reactor. This storage is regarded as part of the fabrication plant.

The conversion of plutonium nitrate solution to PuO_2 is part of the recovery of plutonium at the reprocessing plants in most cases. Some MOX fuel fabrication plants, however, may also be equipped with facilities for plutonium nitrate conversion and for dissolution and purification of plutonium-containing scrap material. Several chemical conversion processes for plutonium nitrate solution or co-conversion processes for uranium-plutonium solutions are industrial standard. The following steps of MOX-powder and pellet fabrication and the manufacturing of MOX fuel assemblies for FBR and LWR are technically very similar to the fabrication of UO_2 fuel assemblies.

4.1 *Enriched uranium hexafluoride conversion to UO_2*

Due to the low radio toxicity of slightly enriched uranium, only limited off-site environmental consequences are to be expected following accidents. However, as in the case of the enrichment process, the safety significance of accidental releases may require a more careful assessment when recycled uranium arising from spent fuel reprocessing comes to be used on a larger scale. In general the special and inherent design safety features and carefully planned operational procedures reduce, to

very low levels, the probability of significant accidents due to plant operation. Both these and external events are considered here.

In the design phase of fuel fabrication plants internal safety hazards such as fire, explosion, release of UF_6 and criticality have to be considered. Adequate precautions are incorporated in the design to reduce the probabilities of these events to an acceptable level. Reliable operation is of equal importance to the safe design of the facility because operational experience clearly indicates that non-routine operations and human error are main contributors to incidents.

Various kinds of external events could have significant consequences for both the plant itself and the environment, and these too have to be considered in the safety assessment. Flooding the facility could be the cause of a criticality excursion, therefore the plants are usually built in a very low flood probability zone. However, if the absence of flooding cannot be ensured design precautions should be taken to prevent the plant from becoming critical in the flooded state. The main hazard in case of an external event such as earthquake or accidental plane crash arises from the possible release of uranium hexafluoride.

Specific safety studies have been performed and safety criteria have been established, in addition to the safety analysis, within the licensing procedure for fuel fabrication plants in some countries [30,31,32,33].

The following possibilities for in-plant-accidents are considered to be relevant:

- release of UF_6 caused by a pipe or valve failure or rupture of a heated UF_6 -container;
- criticality;
- explosion in a fluidised bed or sintering furnace.

Spills or leakages of uranium containing solutions, release of uranium dust due to filter failures, and fire in the scrap purification are other possible incidents. The main hazards, albeit small, to personnel during normal plant operations are associated with:

- the potential inhalation of uranium oxide fine particles when working with powders;
- exposure to external radiation during fuel inspection and storage.

Releases of UF_6 caused by failures of pipe connections or valves have occasionally occurred in fuel fabrication plants. Minor or major contamination with UO_2F_2 , within the conversion building, from the reaction of the released UF_6 with moisture, was the main result of these incidents. No off-site consequences occurred. To prevent the need for major clean-up work after a UF_6 release, a separation or enclosure of the UF_6 conversion plant area is recommended. Rupture of a heated UF_6 -cylinder in the evaporation station at the head end of the conversion process, represents the most severe possibility for a large UF_6 release. In the case of enriched uranium the capacity of UF_6 -cylinders of type 30B is 1.5 tHM. Studies indicate the maximum release of UF_6 in case of a rupture of a heated cylinder for enriched uranium would not be in excess of approximately half of this quantity. Rupture of the conversion furnace itself would only give rise to a small leakage because of the restricted inflow rate used. Modern evaporation stations for UF_6 are equipped and operated with remotely controlled or automatic valves to keep as low as possible the quantities of UF_6 released in case of an incident.

One of the major safety concerns in a commercial fuel fabrication plant and the associated fuel store is the potential for a criticality. Since in most facilities only LEU is handled (with enrichments up to 5% ^{235}U), fabrication steps which are made under dry conditions are inherently safe in the absence of a moderator. In the steps in which hydrogenated fluids are used, mass or geometry controls are applied. In some cases fixed neutron absorbers are additionally used to maintain subcriticality even in the event of accidental moderation and neutron interaction. Off-site exposures from any fission

products generated in criticality excursions are likely to be insignificant. The main hazard will be the local high-radiation fields which are produced by the excursion.

The increased use of recycled uranium in the future will not increase criticality hazard. Also the increase of burn-up probably requires only a small increase of the initial enrichment so that fuels for LWR with much more than 5% ^{235}U are unlikely to be fabricated in large quantities in the foreseeable future.

The use of reprocessed uranium in fuel manufacturing, with higher concentrations of ^{232}U , ^{234}U and ^{236}U induces a higher gamma radiation field due primarily to the formation of the decay products ^{212}Bi and ^{208}Tl . With increasing burn-up the concentration of ^{106}Ru also increase, but this effect disappears after a prolonged storage. The radiological impact of ^{232}U and ^{106}Ru are both time-dependent but in an opposite way. If large quantities of reprocessed uranium are to be handled, improved shielding and encapsulation of uranium are desirable. The level of alpha or gamma-emitting impurities in reprocessed uranium call for improved purification of the UF_6 at the end of the conversion steps and for a substantially improved cleaning of liquid effluents. Studies of these effects and their possible influence on accidental situations should be performed taking into account not only fuel manufacturing but the complete recycling strategy for reprocessed uranium.

In fluidised bed or sintering furnaces, hydrogen is used as a reducing agent, usually diluted with inert gas to prevent the likelihood of explosion. However explosive mixtures can develop from incomplete removal of air from a cold furnace at start-up, or from in-leakage of air into the furnace. Control mechanisms have a low probability of failure, but the possibility of the development of an explosive air-hydrogen mixture cannot be completely excluded. The pressures developed would be sufficient to blow out large quantities of UO_2 powder, if an explosion occurred in a fluidised bed furnace. For a sintering furnace explosion, UO_2 would be blown out of the ends of the furnace in the form of pellets. The release of UO_2 to the environment would, however, be small and its off-site consequences would not be of any significance.

4.2 Specific safety measures for MOX fuel fabrication facilities

The specificity of MFFF safety is connected with the following:

- first of all, the radiotoxicity of plutonium, higher than that of uranium;
- secondly, the dry process fabrication method used in the industrial-size facilities currently in service, which has a potential for criticality and for dispersion of radioactive material;
- finally, the isotopic characteristics of the plutonium used in these facilities, which will have an effect on the criticality likelihood, the risk of external exposure, and the thermal risks.

External exposure and thermal hazards come from the neutron emission from the ^{238}Pu and ^{240}Pu isotopes and the gamma emission from the ^{241}Am which may have “grown into” the oxide by the decay of ^{241}Pu during storage.

A wide variety of hazards have determined the wide variety of adequate safety measures used in MOX fuel fabrication facilities.

4.2.1 Dispersion of radioactive material

Due to the high radiotoxicity of plutonium by inhalation, the safety measures and design characteristics related to MFFF safety are very different from those characterising the fabrication of uranium-based fuel.

The design-related measures taken to prevent the dispersion of radioactive material are based on containment systems whereby a series of static barriers is interposed between the radioactive material and the environment. The first containment system generally comprises a static barrier interposed between the personnel and the radioactive material. It may consist of glove boxes in which the process equipment is installed, the process equipment itself, welded fuel rod cladding, sealed containers intended for the transfer of the radioactive material, etc.

The second static barrier consists of the walls of the premises that contain the equipment ensuring the first barrier. The third and last barrier consists of the walls of the buildings. The second barrier contributes to the protection of the permanent workstations (control rooms in particular) and the third barrier guarantees that the environment is unaffected.

The quality of these static barriers is taken into account during the design and construction phases, particularly through the selection of materials adapted to withstand the stresses that they may be subjected to (mechanical, thermal, etc.), through the seismic design of certain structures and equipment, through the quality of construction and manufacture, and through inspections to verify this quality. The quality of design and construction of the first containment system must guarantee the absence of contamination within the plant premises during normal operation.

A dynamic containment is associated with these static containment barriers and complements them. It ensures a cascade of negative pressures directing the air circulation from the potentially less contaminated areas towards the potentially more contaminated areas. This system also ensures purification of the air before its discharge to the environment by trapping the possibly contaminated elements in a series of HEPA filters associated with each static containment barrier. The organisation of the buildings in containment systems, with their associated specific ventilation system, results in a division of the facilities into different areas according to the level of contamination risk, whereby different areas are accessed via air-locks.

The ambient activity rate of the premises where the glove boxes or radioactive material in sealed containers are installed is constantly monitored by systems that continuously sample and examine the work atmosphere, through real-time alpha activity measurements (EDGAR system) or time-delayed measurements.

Operating methods and maintenance must guarantee the observance of the design and construction measures: constant negative pressure within the glove boxes, leak-tightness and radiological cleanness of the premises, and the efficiency of the incidental contamination detection systems and of the filtering systems.

Specific practical training programmes dedicated to work within the glove boxes are provided to the plant operators. They are intended to provide the means of personal protection in case of risk of internal exposure, and to see to it that the rules to reduce the risks inherent in glove box operations (and their consequences) are observed.

In the late 90s, COGEMA has carried out significant research and development work, in collaboration with other manufacturers, to improve the mechanical performance of the gloves

equipping the glove boxes, to test the materials best suited for their use, and to master the fabrication processes, making it possible to guarantee their quality of manufacture.

4.2.2 *External exposure.*

The isotopic composition of the plutonium used requires that the risks from gamma radiation and neutron emission be taken into account. The gamma radiation varies according to the ^{241}Am content. The neutron emission varies according to the concentration of even isotopes in the plutonium, particularly the ^{238}Pu content. It is most significant in the assembly fabrication workshop. The corresponding dose rates cannot generate a significant likelihood of external exposure in routine operation.

The design-related measures intended to reduce the exposure of the operators to radiation include automation or remote control of the operation and of the product quality monitoring techniques, installation of protection screens suited for the nature and energy of the radiation, and design of process equipment to reduce the number and duration of interventions. During operation, the principal measures must proceed from application of the ALARA principle.

4.2.3 *Criticality*

The presence of significant quantities of fissile material (^{239}Pu , ^{241}Pu) in the equipment of the industrial-size MFFF, the various stages of the elaboration of the MOX blend, and the incorporation of hydrogenated material at some of these stages call for specific safety measures regarding criticality. The prevention of criticality is firstly based on the characterisation of the fissile material during the various stages of the fabrication of the MOX fuel: isotopic composition of the plutonium and uranium, physical and chemical form (powder, granules, pellets, fuel rods), density of the blend, PuO_2 content of the blend, and concentration of hydrogenated products in the blend. The full knowledge and control of these essential variables must be justified, as well as limiting their value in any situation. Second of all, the prevention of criticality is based on the determination of the control methods best suited for the process for each item of equipment or part of the facility.

The main control modes used (individually or in combination) in MFFF are the geometry of the equipment (particularly interim storage), mass, and moderation. In certain cases, neutron-absorbing fixed materials are also used to maintain a subcritical condition, even in the event of accidental moderation or neutron interactions.

The fact that the MOX fabrication process employs dry (or weakly moderated) fissile material and the use of moderation as a control mode associated to the mass or geometry calls for strict measures regarding design and operation so as to guarantee the limitation and control of the moderation in all situations. The accidental situations, in which the full control of criticality must be demonstrated, are studied by taking the other hazards into account (thermal hazards, fire, flooding, earthquake, etc.).

In addition, a criticality detection and alarm system monitors all parts of the facility where a criticality excursion is plausible.

4.2.4 Thermal hazards

The thermal power of the plutonium requires that the release of heat be taken into account. This release of heat must not lead to a deterioration of the safety functions, which are essentially containment of the radioactive material, protection against ionising radiation, and prevention of criticality. The main points to be examined concern the places where significant masses of material are concentrated: powder, pellet, fuel rod, and assembly interim storage, as well as large capacity homogenisers. The possible consequences of a complete loss of ventilation, the means generally used to remove the heat, must be evaluated.

4.2.5 Fire

Unlike a criticality excursion or an explosion, a fire is rarely a sudden event and often breaks out from a small source. The persons responsible for the design, construction, and operation of fuel fabrication facilities carefully consider the possibility of fires and provide for the equipment and procedures required to prevent them.

Although the nuclear materials used during the processing (uranium and plutonium oxides) are not flammable themselves, certain elements of the equipment, such as the glove box panels, may be made of more or less combustible material. In addition, a fire may be connected with the interim storage of combustible waste or fluids and break out further to flammable gas leakage.

The principal general preventive measures concern the choice of materials, methods, and equipment and the limitation of the heating load within the premises. The use of fast kinetics combustible substances must be limited as much as possible.

According to the in-depth protection concept, the next step is to provide for a quick detection of the fire by installing equipment suited for the expected events.

In order to limit the propagation of the fire, the facility is divided into fire and containment sectors. Finally, the means of intervention must be provided, including trained intervention teams and devices such as fixed CO₂ injection systems. The ventilation must be designed and controlled in order to protect the last filtering stage to minimise discharge to the environment.

A fire must not lead to a criticality excursion through the deterioration of a neutron absorber, a modification of dimensions, or the moderation of fissile material when a hydrogenated extinguishing substance is used. Finally, a localised fire must not jeopardise the availability of the criticality accident detection equipment. A large fire not properly subdued may lead to significant consequences on the environment. These consequences must be assessed.

4.2.6 Explosion

The mixture of gases supplying the high-temperature sintering furnaces has a concentration of H₂ (in argon) limited to 8% in order to control the flammability and explosion of this gas in air. The mixture is either prepared outside the nuclear facility and its content verified before use, or prepared on line from component gases. In the latter case, safety features are incorporated in the gas mixing equipment, such as electromechanical isolation valves interlocked with gas analysis system.

The potential for explosion also comes from the radiolysis occurring, for the most part, in solutions containing plutonium and leading to the release of H₂. However, solid waste and unsintered process rejects containing hydrogenated additives may also lead, with slower kinetics, to the production of H₂. Corresponding volumes are ventilated in order to keep H₂ concentration always below flammability limit.

4.2.7 Hazards of external origin

External hazards can become initiating events for risk-significant incidents or accidents. The following hazards must be systematically taken into account, as they are in all nuclear facilities:

- Earthquakes: in addition to the design of the facility, it is necessary to examine the risk of fire (due to the use of flammable gases) and the risk of criticality excursion, that might be both caused by an earthquake.
- Flooding: caused by tides, streams, and rainfall, possibly resulting in a dispersion of material as well as in a risk of criticality excursion.
- Risks related to the industrial environment and transport routes: the main hazards are explosions and toxic clouds. Regarding transport, accidental aircraft crashes must be considered (a probabilistic approach may be used to quantify this risk).
- External fires, extreme temperatures, wind, and snowfall.

5. References

- [1] ICRP (1990), *1990 Recommendations of the International Commission on Radiological Protection*, Annals of the ICRP Publication 60, Vol. 21/1-3.
- [2] Locke, D.H. and Smith, J.R. (1993), *The Nuclear Engineer*, Vol. 34, Issues 3 and 4, May/June and July/August.
- [3] Lancashire County Council (UK) (1996), *Offsite Plan and Handbook for BNFL Springfields Fuel Division* (as amended).
- [4] Fishwick, A.H., Finlayson, J.L. and James, R.D. (1992), Proceedings of International Conference on Radiation Effects and Protection, JAERI, Mito, Japan, p. 430.
- [5] Fishwick, A.H., Finlayson, J.L. and James, R.D. (1992), Proceedings of International Conference on Radiation Effects and Protection, IRPA 8, Montreal, Canada, p. 837.
- [6] Finlayson, J.L. (1998), I Chem E Internet Conference, Safety 98, Institution of Chemical Engineers, Rugby, United Kingdom.
- [7] Finlayson, J.L. (1995), "Radiation Dose Management in the Nuclear Industry", Proceedings of BNES Conference, Windermere.
- [8] BNFL (1997), *Safety, Health and Environment Report* (1997 and other years), Risley, Warrington, United Kingdom.
- [9] Fishwick, A.H., Finlayson, J.L. and Dower, B. (1994), *Radiation Dosimetry*, Vol. 53, Nos. 1-4, p. 21.

- [10] Price, A. (1989), *Radiation Protection Dosimetry*, Vol. 26, Nos. 1-4, p. 35.
- [11] Finlayson, J.L. (1999), *An Internal Dose Investigation*, Soc Rad Protection, 6th International Symposium, Southport, United Kingdom.
- [12] AEN (1978) CSNI Specialist Meeting on the Safety Problems Associated with the Handling and Storage of UF₆, OECD, June, Paris.
- [13] Cain, C.L. and R. Chappel (1986), *Rupture of Model 48 1 UF₆ Cylinder and Release of Uranium Hexafluoride*, US NRC (Nuclear Regulatory Commission), NUREG-1179, February.
- [14] US NRC (1986), *Assessment of Public Health Impact from Accidental Release of UF₆ at the Sequoyah Falls Corporation Facility at Gore, Oklahoma*, US NRC (Nuclear Regulatory Commission), NUREG-1189, March.
- [15] Finlayson, J.L., Fishwick, A.H. and Morton, A. (1996), *I Chem E Loss Prevention Bulletin*, No. 130, p. 3.
- [16] Bhanot, K.E. (1999a), "Development of a Criticality Emergency Planning Code of Practice", Soc Rad Protection, 6th International Symposium, Southport, United Kingdom.
- [17] Bhanot, K.E. (1999b), *Proceedings of International Conference on Nuclear Criticality (1999)*, Vol. II, p. 907, Versailles, France.
- [18] Nuclear Installations Act, 1965 (as amended), Nuclear Site Licence, BNFL plc, Springfields Works, No. 30G.
- [19] Gill, G.G. (2000), "Implementation of the COMAH Regulations at BNFL Springfields", Proc of ESREL 2000, SARS and SRA-Europe Conference, Edinburgh, Scotland, May 2000, p. 1025.
- [20] Gill, G.G. (1999), "Application of Some Aspects of the REPPiR Regulations", Soc Rad Protection, 6th International Symposium, Southport, United Kingdom.
- [21] Finlayson, J.L., Fishwick, A.H. and Gill, G.G. (1995), "Procedures for Plant Safety Cases in the Nuclear Industry", *I Chem E Loss Prevention Bulletin*, No. 123, p. 19.
- [22] Rice, S. and Buchan, A. (2000), *Nuclear Energy*, Vol. 39, No. 1, p. 19.
- [23] Certificate of Authorisation – Disposal of Liquid Radioactive Waste from BNFL Springfields Works, August 1991.
- [24] BNFL (1999) Annual Report on Discharges and Monitoring of the Environment (1999 and previous years), Risley, Warrington, United Kingdom.
- [25] Hughes, J.S. and Shaw, K.B. (1996), National Radiological Protection Board, NRPB-M748, Chilton, Didcot, UK, OX11 0RQ.
- [26] Environment Agency (1999), "Radioactivity in the Environment", Report for 1999, ISBN 1857054946 and previous years.

- [27] BPEO Study (1993) for Springfields Liquid Radioactive Wastes, BNFL, Preston, United Kingdom.
- [28] NEA (1988), *Summary of Nuclear Power and Fuel Cycle Data in OECD Member Countries*, OECD, Paris.
- [29] IAEA (1988a), *The Nuclear Fuel Cycle Information System. A directory of Nuclear Fuel Cycle Facilities*, Vienna.
- [30] Dasté, B. (1980), « La sûreté dans la fabrication du combustible nucléaire », *Annales des Mines*, 186^{ème} année, No. 6, June, pp. 63-76.
- [31] EPRI (1979), “Status Report on the EPRI Fuel Cycle Accident Risk Assessment”, NP-1128, (Electric Power Research Institute), July.
- [32] Thomas, W., Hesse, U. and Warnemunde, R. (1981), “Sicherheitsanalyse zur Rezyklierung von Plutonium in LWR”, *Teile A und B, Brennelementherstellung*, GRS-A-569, Marz.
- [33] Der Bundesminister des Innern (1983), “Sicherheitsanforderungen für Kernbrennstoffversorgungsanlagen”, Teile 11, Ill. RS-AGK 5 -510321/2, Juni.

Chapter 6

SAFETY OF THE SPENT FUEL STORAGE

Several technologies are being used for the storage of spent fuel at reactor (AR) sites and at sites away from reactors (AFR) (Figure 6.1). Both wet (pool) storage facilities and dry storage facilities (buildings and containers) are used on a commercial scale.

The safety of spent fuel storage has been extensively evaluated. The NRC reported in the “Waste Confidence Decision” of 1984 [1] that there is reasonable assurance that spent fuel can be stored safely and without significant environmental impact in reactor pools or in AFR spent fuel storage installations. For both dry storage and wet storage, the NRC stated its belief that current storage technologies are capable of providing safe storage for at least 30 years beyond the active lifetime of the reactor facility. The NRC also concluded that the possibility of a major accident or sabotage at a spent fuel storage facility with radiological consequences for the public is extremely remote. The BEFAST I report [2] followed by the studies of BEFAST II (1986-91) [3], BEFAST III (1992-97) [4] and further study [5] as well as the survey of experience in the storage of nuclear fuel by the IAEA [6] support the confidence in longer term wet and dry storage. In the IAEA report on fuel cycle status and trends [7] it is stated that there is a general consensus that feasible and proven technologies have already been developed and exist for short- and long-term storage of spent fuel.

Figure 6.1. Pool storage (Source: COGEMA – France)



Considerable experience has been gained in the transport of spent fuel elements and in the consequent safety-related development of suitable transportation casks. This experience has made it possible to develop a concept for dry storage of spent fuel elements within transportation casks; dry storage containers generally have not been the transportation casks themselves. At Gorleben and

Ahaus in Germany, AFR dry storage facilities that use this concept have been licensed. This concept is based on three essential safety requirements:

- The casks for dry storage of spent fuel elements must satisfy the stringent requirements of type B(U) transport casks [8,9] for the whole lifetime of the facility.
- A system of quality assurance and inspection is instituted to guarantee that the requirements for type B(U) casks identified above are satisfied.
- The cask has to fulfil the “two barrier principle”, which means that the release of radioactive materials into the environment has to be prevented by a double-lid system together with the equivalent very strong cask itself.

The concept of the so-called “dual purpose” (storage/transport) cask has recently [10] been licensed in the United States in the framework of a new policy of dry storage in Independent Spent Fuel Storage Installations (ISFSI). According to this new policy the reactor operators are entitled to store the spent fuel elements, which have cooled in a pool for at least one year after unloading from the reactor, in specially licensed containers under dry conditions for 20 years or more. A number of storage casks have received official approval for that purpose, e.g. CASTOR V21, MC10, NAC S/T, NAC-C28 S/T, etc.

The US DOE is sponsoring a study to determine the effects of a long-term normal storage (20 to 30 years) on the performance of a storage cask in transportation. Included in the study are the effects of radiation, corrosion and heat on the container. The safety problems associated with the short-term storage of spent fuels arise from the high-fission product content of the fuels and the presence of fissile materials. The beta-gamma activity in LWR spent fuel six months after unloading from reactors still amounts to about 150 TBq/tHM. The plutonium produced in a PWR fuel assembly is about 4 kg. Thus, a 1 000 tHM fuel storage facility has a plutonium inventory on the order of 9 t and the maximum heat evolved from the fission products in the fuel after one year's cooling time is about 12 MW.

Although the inventory of radioactivity is high, dispersion and release of any significant proportion of it cannot take place either rapidly or readily.

1. Wet storage facilities

1.1 At reactor (AR) pool storage

This is a highly developed technique which is the standard method used worldwide for short-term storage of spent fuel. The continuous production of spent fuel by the power reactors all over the world and the delay in developing the required reprocessing capacity or long-term storage facilities prompted the reactor operators to increase the pool storage capacity by enlarging existing pools, building new facilities and increasing the specific fuel density in the pools (re-racking).

1.2 Away from reactor (AFR) pool storage

AFR wet storage facilities have been commissioned and are now in operation, notably the CLAB facility at Oskarshamm in Sweden and the TVO-KPA facilities at Olkiluoto in Finland. The CLAB facility was commissioned in 1985 and has a capacity for 5 000 tHM being extended to 8 000 tHM. About 4 000 tHM are stored as for end of 2003 (3 450 tHM as for 31 October 2001). The storage section of the facility has been constructed entirely under ground in a rock formation. The TVO-KPA facilities began operation in 1987 and have a capacity for 1 200 tHM.

1.3 Pool storage capacity at reprocessing sites

In France, COGEMA has completed an extensive programme to expand the wet storage facilities at La Hague. The total capacity of the facilities amounts in 2003 to 18 000 tHM. Seismic considerations have been taken into account for these new pools where the pool structures are supported on visco-elastic pads.

At Sellafield in the United Kingdom, the storage capacity has been expanded to around 10 000 tHM. At Tokai mura in Japan the storage capacity is now 140 tHM, and at Rokkasho mura the storage capacity is 3 000 tHM.

1.4 Safety issues with wet storage of spent fuel

Table 6.1 [11] compares fuel conditions in the reactor and in the storage pools, emphasizing the much more benign environment of the latter. Temperatures and radiation fluxes are lower in the pool, and there is no intrinsic driving force for the sudden release of a major fraction of the radioactive materials contained in the stored spent fuel even under abnormal operating conditions. Pressures are generally lower in-pool, but pressure differences are more favourable in-reactor (outside overpressure) than in-pool (internal overpressure). However, no loss of tightness has ever been recorded during storage in pools.

Table 6.1. Comparison of conditions for water reactor fuel

Parameter	In-reactor	In-pool
Fuel temperature (°C) (peak centreline)	1 200-1 700	100
Water temperature (°C)		
BWR	270-300	20-50
PWR	320-340	20-50
Cladding inside surface temperature (°C)	340-400	30-60*
Gas pressure MPa**		
LWR	0.5-15	0.2-8
Fission gas evolution (in per cent)		
BWR	2	negligible
PWR	15	negligible
Surface heat fluxes (W/cm ²)	up to 80	0.03
Radiation fluxes (max)		
Neutron (n/cm ² .sec) > 1 MeV	3 to 6 x 10 ¹³	10 ⁵
Gamma (Gy/h)	10 ⁷	10 ³

* After cooling for several weeks; the exterior surface temperature is ~10°C above the bulk water temperature; the interior and exterior clad surface temperatures are essentially the same at pool storage conditions.

** 1 MPa = 10 bar = 145.04 psi. Values quoted in original reference have been rounded off.

The zirconium based or stainless steel cladding of the fuel rods is the most efficient barrier against fission product release during handling and storage of spent fuel elements (stainless steel cladding is practically no more used now for LWR, but stainless steel clad fuels are still in storage, particularly FBR fuel). Consequently, knowledge of those cladding properties that determine the fuel rod integrity is important. Visual examination and radiation monitoring have revealed no evidence of

any degradation in the stainless steel or Zircaloy clad uranium oxide fuel which has been stored for periods of 10 to 20 years. Examination of some CANDU fuel stored for 27 years revealed no deterioration of the cladding [12]. The situation is less favourable with Magnox clad metallic uranium fuel, but only if the cooling water chemistry is incorrect when there then may arise some indications of the occurrence of progressive cladding failure.

Mechanical damage during reactor unloading and fuel handling in the pools appears to have been minimal.

The hydrogen concentration found in Zircaloy fuel rod cladding at the end of reactor residence time is typically several 100 parts per million. When the fuel pin is cooled to approximately 40°C, after shutdown, a large part of the hydrogen in the cladding tube is precipitated in the form of finely dispersed hydrides. It is known that this precipitated hydride enhances the cladding strength although ductility is reduced. Since no fuel deformation occurs during handling operations, this reduction in ductility should not result in any additional defective rods entering the storage pool. Experience endorses this assertion.

It is known that for longer storage times at normal pool temperatures of approximately 40°C no increase in the size of hydride precipitates occurs.

There are slight temperature differences between the extremities of the stored fuel assemblies, caused by the upward coolant flow, but no redistribution of hydrogen by thermal diffusion mechanisms is anticipated because of the very low diffusion coefficients and the negligible solubility at this low temperature.

Given adequate control of water purity, which is important in the corrosion context, it is known that Zircaloy is virtually immune to corrosion by oxidation in water under the long-term storage conditions of fuel assemblies. Likewise, fission product induced corrosion will be negligible.

Cladding stress corrosion cracking phenomena have been considered. Caesium and iodine are not present in elemental form, due in part to the formation of CsI for example, and therefore do not contribute to cladding degradation from stress corrosion. There is significant stress relief in the cladding as it cools down under storage conditions. Stress corrosion does not appear to be a problem in spent fuel storage.

The structural parts in fuel assemblies consist of a number of materials including Inconel, Zircaloy-2, Zircaloy-4, other zirconium alloys and austenitic stainless steel. Corrosion of these parts by pure oxidation in the water at a pool temperature around 40°C can be excluded. At this temperature, electrochemical corrosion of the stainless steels can be avoided by appropriate control of pool water quality. At the end of their service life, the structural parts of the fuel assemblies are covered with an intact oxide layer which is a major factor contributing to the inhibition of electrochemical attack during storage.

Direct exposure of persons working in storage facilities can occur during such activities as handling of fuel casks and fuel assemblies, handling of contaminated filters, and repair and maintenance work. Experience shows that, in common with other fuel cycle facilities, the risk of increased occupational exposure arises when any maintenance or unusual operations are carried out. Such increased exposures can, however, generally be minimised by good planning, adequate redundancy of critical components, paying particular attention to the design of those items that are liable to become contaminated from the point of view of repair and maintenance, and by the use of

local shielding and equipment decontamination procedures. Systems and components that are important in this context include:

- pool water cooling and make-up systems;
- filter equipment for purification of pool water and decontamination of fuel flasks;
- ventilation systems;
- equipment for temperature, water level and leakage measurement in the pools;
- hoists and handling systems for flasks, canisters and fuel assemblies;
- equipment for handling and storage of spent filter resins and other wastes.

There have been no serious incidents at spent fuel storage facilities involving significant radiation exposure of workers or the general public. However, some contamination of storage pools has occurred due to defective fuel or cladding corrosion, the latter particularly in the case of Magnox clad fuel storage in water whose chemistry was not controlled. Such contamination has been found to be a major source of operator dose and local spread of contamination.

Shielding is normally ensured by providing a minimum of 4 m depth of water above the fuel elements in storage, which is enough to reduce the dose rates to less than 0.01 mGy/per hour at the pool surface. Fuel transfer mechanisms have limit switches and mechanical stops to prevent the inadvertent raising of a fuel element to within less than 3 m of the water surface. A high-integrity pool structure is needed in order to guarantee adequate containment of the pool water, but a limited loss of water resulting in a significant reduction of the shielding layer is unlikely to involve significant over-exposures to personnel since adequate countermeasures can be taken in time.

1.4.1 Possible accidents in wet storage

In the safety analysis of a spent fuel storage pool a number of anticipated disturbances and minor accidents have been identified. These include loss of off-site power, component failures, leakage of pool water and fuel handling faults. A proper design ensures that significant releases of radioactivity will not occur under these circumstances and that the resulting environmental impact will be negligible [13].

Radioactive contamination of pool water can result if those fuel elements which have developed defects during reactor exposure are not identified and isolated and are therefore stored in the pools together with intact fuel. Radioactive contamination of the pool water, for occupational safety reasons, has to be maintained at levels of about 30 MBq/m³ or less by means of ion exchange and filtration. Additional leakage of activity from defective irradiated fuel appears to occur only slowly under storage conditions, the soluble species having already largely been dissolved in the reactor coolant in most cases.

A prerequisite for a significant release of radioactive material to the environment under more severe accident conditions is the damage of the cladding of a fairly large amount of stored fuel, with an accompanying release of gaseous and/or airborne activity from the fuel. Two conceivable mechanisms which might lead to this situation have been identified. One possibility is that the fuel overheats so that the fuel cladding loses its integrity; the other is a massive mechanical impact on the stored fuel.

A necessary condition for the former is the loss of pool water to such an extent that cooling of the stored fuel ceases and the fuel temperature increases due to decay heat. The pool water could be lost either by leakage at a rate in excess of the make-up system capability or due to failure of the pool

water cooling system together with loss of make-up water capability to compensate for the evaporation which would follow pool overheating. However it has to be kept in mind that loss of water from the pool structure is inherently a slow phenomenon with only gradually increasing severity for which corrective measures can be taken in due time.

The circumstances in which an event could lead to severe mechanical loading of the fuel have been identified as:

- handling faults, e.g. fuel cask lifting device failure;
- external events (earthquake, tornado, flood or accidental aircraft crash, etc.) which could cause structural failure.

Such events are taken account of in the formulation of design safety requirements. In addition to direct releases of activity following such incidents, the possibility of the subsequent initiation of other accident sequences such as criticality accidents and loss of cooling water should not be overlooked in the safety assessments.

The most severe potential accident for a wet storage facility appears to be one which involves complete loss of water from the pool due to, for example, an earthquake. To cope with this hazard a seismic design will be adopted for the pool structure, taking into account historical data and characteristics of site foundation in seismic events. Therefore an occurrence of such a severe accident is extremely improbable. Even if the cracking of the concrete pool structure was hypothesised it might not lead to catastrophic failure because any elastic return of the rebar configuration would cause the crack to close-up, to an extent, after cessation of the earthquake load. It is recognised that storage pool integrity, avoidance of large-scale mechanical damage to the fuel, and provision of adequate make-up water supply systems to cope with loss of pool cooling situations are the most important design considerations. Double-barrier pool construction is now common design practice for ensuring pool integrity and it also aids monitoring for leakage. There are, however, a number of other safety-related structures and systems, which include:

- the ground housing the storage pools;
- the building structure;
- the storage pool structure;
- canisters or baskets for the spent fuel;
- pool water cooling systems;
- emergency make-up water systems.

If the storage period of spent fuel were to be increased significantly over presently envisaged levels, the only additional safety problems which would appear would relate to fuel assemblies during re-racking and the integrity of fuel assemblies during re-packaging and re-shipping for reprocessing or disposal.

The main considerations relating to the closer packing of spent fuel in the storage pools are:

- the storage configuration remains subcritical;
- the heat load will not raise the water to an unacceptable temperature under normal operating conditions;
- the additional weight of the fuel will not cause failure of the liner or the structure under normal and design basis accident conditions (i.e. fuel cask drop).

The additional heat load will not be a significant problem if only relatively old fuel is stored in this manner.

Compact racks and close packings of consolidated fuel may also influence the seismic design and emergency preparedness.

1.4.2 Loss of power supply

Although the cooling system and electrical power supply provisions normally include a measure of redundancy, this may not be essential on safety grounds alone for independent spent fuel storage facilities. Immediate restoration of cooling following an interruption should not be necessary and, if the failure condition persists, the make-up water supply should be adequate to prevent a serious fault escalation sequence from developing.

Normal plant provisions include redundant components which are powered from separate bus bars so that the only common component in the AC power supply system is the main switchgear. Arrangements are also normally made for the main switchgear to be manually connected to an independent on-site power source. The on-site power supply may be a stationary or mobile diesel generator or a gas turbine installation.

A loss of off-site power for longer than a few hours has a very low probability. Loss of both off-site power and the independent on-site supply has an even lower probability and it is therefore considered that the power supply loss fault is not significant in the context of the safety of the pool cooling system. Furthermore the cooling system of a spent fuel storage pool could be stopped for a significant period (at least ten days in most cases) without any effect on fuel integrity [14].

1.4.3 Fuel element handling faults

A fuel handling accident such as dropping a fuel cask or canister gives rise to possible radioactive releases to the environment and may result in severe damage to the storage facility. Rupture of the cladding can occur, but if the fuel has been cooled for more than six months the only isotope of importance which may reach the environment would be ^{85}Kr . However ^{85}Kr does not contribute significantly to the off-site individual exposures because it is a readily dispersed inert gas. ^{129}I does not appear to be a problem due to the small amount of its activity in the fuel. In the unlikely event that an accident occurs with fuel which has been cooled for less than six months, ^{131}I could also be released. However ^{131}I , with a half-life of eight days, would not become an environmental contamination concern. Protection of the pool structure against such faults and the provision of high-reliability handling systems are measures which are implemented.

1.4.4 Criticality

Criticality safety in storage pools is generally ensured by the design of the baskets and racks for the fuel assemblies, primarily by diminishing neutron interaction by adequate spacing of the positions for the fuel assemblies. In many cases additionally fixed neutron absorbers, like boron steel plates, are used to reduce the distances between the positions and to enhance the storage capacity. Consideration is also given to possible handling failures, especially to drops of fuel assemblies or heavy loads. Also in the event of an earthquake subcriticality of the stored fuel must be maintained. The criticality safety concept for AFR pools was originally based on the assumption of fresh fuel, not taking into account

the reduction of fissile material and the neutron absorption of fission products due to the burn-up. Most AFR pools now take credit of the burn-up to store high enrichment elements in baskets or racks designed for lower enrichment elements (See also end of Section 7-3.1). This requires strict control of the initial enrichment and the guarantee of a minimum burn-up – which can be checked with relatively simple equipment before leaving reactor site – to avoid the erroneous loading of higher enriched fresh fuel. Similarly repair or consolidation of fuel assemblies within wet storage pools needs specific attention to maintain subcriticality for all steps of operation.

For some fuel, higher density storage may result in reduced moderation and favourably reduce the nuclear reactivity of the system.

Compact racks and close packings of consolidated fuel may also influence the cooling requirements, the seismic design and emergency preparedness.

Special attention is given to the criticality hazard present in some fuel transport and handling operations. Some PWR fuel transport flasks contain borated water, as do the storage pools at reactor sites, and this water is usually flushed out at storage or reprocessing site receipt station. Before authorising this flushing out process or the immersion of a flask into the unloading pool, the water of which is not borated, a careful check of the fissile material content is made on the basis of the safety report of each container and the shipper's documents to ensure that criticality safety shall be maintained. Quality assurance procedures play an important role in this check.

Criticality safety is ensured during fuel handling by applying the principle of transferring one fuel element, basket or bottle at a time. This may be achieved in pools in a number of ways; by fixed geometry (stops), by limitations on the permitted loads of handling systems or by redundant interlock arrangements.

Criticality accidents in pool storage systems are not likely to give rise to any release of radioactive material to the environment.

1.4.5 Loss of cooling

In the event of total loss of cooling, the thermal capacity of the pool water is sufficient to keep water temperature below boiling point for a period in excess of at least 24 hours and perhaps as long as several years, depending on the original depth of water above the stored fuel and on the quantity and the irradiation history of the fuel. It is expected that adequate time would be available to take corrective action even if complete loss of cooling occurred. As an example, a moderate water flow-rate of the order of 10 m³/hour would be sufficient to maintain a constant level in a typical pool and therefore prevent boil-off of the water and consequent cladding failure and fault escalation. However, the water flow rate for a particular spent fuel pool is dependent on the fuel burn-up, the decay time, the water volume, and pool configuration. Supplies of make-up water are usually constantly available to offset evaporation losses if it is not possible to reactivate the cooling system within an adequate time.

Under normal circumstances the pool water temperature is kept below 40°C to maintain a habitable environment within the building without excessive ventilation. This is generally well below the structural design wall temperature limit. Structural damage to the main pool envelope and its liner may occur if the water temperature increases significantly beyond design limit – when this one is below 100°C – and remains there for a long period of time. However, if such a temperature rise is only for a short time corresponding to a transient boiling accident, it will not affect the pool structure. Nevertheless, further studies to analyse spent fuel heating following loss of all the pool water have

been made in order to get an insight into this extreme accident (which is a beyond design accident). Among them IRS-290 [15] caused a public stir, because of a misunderstanding of the report's conclusions. However, the position of that report on such a severe accident was made clear afterwards by the same author, who made efforts to correct the misunderstanding [6].

A somewhat more comprehensive analysis has also been performed for the NRC by Sandia Laboratories to determine the temperature rise of spent fuel following a hypothetical accident involving draining of a storage pool [16,17]. Moreover deterministic studies are in progress in France on the low probability, and beyond design basis, accidents for large storage pools. In the light of these studies, it is confirmed that in any circumstances, priority should be given to keep a minimum quantity of water in the pool, to ensure at the same time cooling and radiation shielding.

In 2001, NRC performed an evaluation of the potential accident risk in a spent fuel pool at decommissioning NPPs [18]. The study was prepared to provide a technical basis for decommissioning rulemaking for permanently shutdown nuclear power plants. The study described a modelling approach of a typical decommissioning plant with design assumptions and industry commitments; the thermal-hydraulic analyses performed to evaluate spent fuel stored in the spent fuel pool at decommissioning plants; the risk assessment of spent fuel pool accidents; the consequence calculations; and the implications for decommissioning regulatory requirements. It was known that some of the assumptions in the accident progression were necessarily conservative, especially the estimation of the fuel damage. As a result, the NRC is (as of the first part of year 2004) in the process of producing more realistic assessments of critical parts of the pool storage accident scenarios. There will be an independent peer review by the US National Academy of Sciences and the results should be available some time in 2005.

2. Dry storage facilities

2.1 Status

The dry storage of spent fuel is increasingly being used in several countries. The dry storage concepts currently being implemented include: dry wells, metal casks, silos (concrete casks), and vaults.

2.2 Dry wells

In Japan, a dry well storage facility for spent uranium metal fuel from a research reactor has been in operation since 1982. The facility stores about 15 tHM of such fuel. The IAEA survey [6] reported that there have been no abnormal occurrences or requirements for remedial action at the facility. In the United States, LMFBR fuel was stored in dry wells at INEEL. Dry wells were used for the storage of small amounts of PWR fuel at the Nevada Test Site (NTS) as part of a large dry storage demonstration programme. Storage started at the Climax deep dry wells (600 m below the surface in granite) in 1979. In 1983 the PWR assemblies were moved to a vault and dry wells to the EMAD facility. One of the elements has been submitted to an extensive characterisation through non destructive and destructive examination. No significant problems were identified.

2.3 Metal casks

Designs of metal casks for use in spent fuel storage have been in existence since the late 1970s. The cask designs have capacities ranging from 4 to 26 PWR fuel assemblies and from 10 to 60 BWR

assemblies. The tendency there, the same as for wet storage, is to take into account some burn-up credit that allows for more compact design. The casks are generally equipped with a double-lid system to ensure safe containment of contents. These casks have been subjected to a variety of tests and demonstrations since the early 1980s using both intact and consolidated fuel.

In Germany, full-scale demonstrations of spent fuel storage, in casks manufactured from nodular cast iron, have been in progress since 1982. In Switzerland, about 3 tHM of spent fuel (in 50% consolidated form) has been in storage in nodular cast iron casks since 1983. At the time of the IAEA survey [6] there had been no abnormal occurrences, however no fuel had been retrieved for inspection. Since 1984, four types of metal storage casks have been tested in the United States. The DOE sponsored the demonstration of the storage of BWR fuel in metal casks at the Morris storage facility in 1984 and 1985. The DOE entered into a co-operative agreement with Virginia Power, a United States utility, to demonstrate the use of three types of metal casks. The AFR US site at the Virginia Power Surry nuclear power station has been licensed by the NRC for storage of spent fuel in metal casks. At the INEL site one case of degradation had been observed. After the first series of tests, cracks were observed in the welds of the borated stainless steel basket.

The first central AFR storage facility in Germany with an initial capacity of 1 500 tHM has been built at Gorleben. This facility makes use of the principle of dry storage of irradiated fuel elements in transport containers of the GNS-type (CASTOR) or TN-type, in which the fuel elements are kept in a helium atmosphere to allow a long-term storage. This interim storage facility was completed in 1983 and taken into limited operation later. Its capacity has been extended to 3 800 tHM. A second storage facility at Ahaus received a construction licence in 1983. Results of demonstration activities have shown the following:

- radiation and thermal levels have been acceptable;
- no fuel rod failure has occurred during demonstration storage;
- no secondary wastes have arisen from the storage operation.

Germany has decided to commission on each reactor site a dry storage facility on the model of Gorleben's one, able to house the spent fuel of the site for the whole remaining lifetime of the reactors of the site. The first of these twelve facilities has been commissioned in November 2002 at Emsland site (Lingen), with a capacity of 1 250 tHM in 125 metal casks (Figure 6.2).

Figure 6.2. Dry spent fuel storage in steel casks at Emsland (Germany)

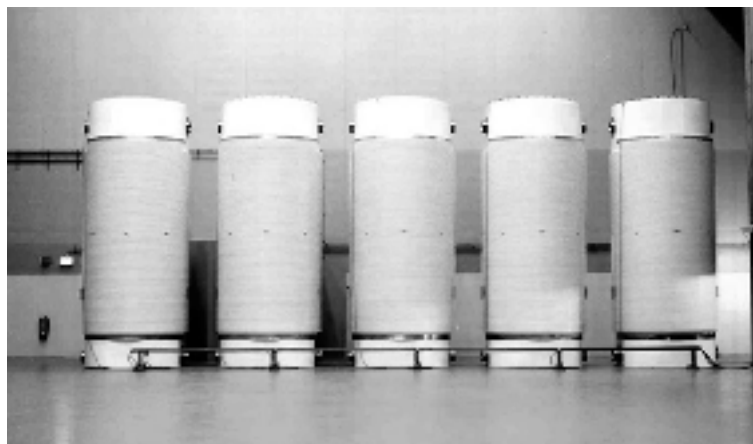

2.4 Silos (concrete casks)

Concrete cask technology has been used for the storage of spent fuel in Canada and the United States, and is also under development in other countries. In Canada, demonstration programmes for dry storage in concrete casks of commercial CANDU fuel under various environmental conditions, and of various production fuel on a routine basis, are being carried out at the Whiteshell Nuclear Research Establishment. Sixty-seven tHM of CANDU fuel are also being stored at the Gentilly reactor site. There have been no problems or abnormal occurrences with the storage of spent fuel at these sites. In the United States a concrete cask containing PWR spent fuel assemblies was successfully tested as part of a major dry storage demonstration conducted at the Nevada Test Site.

2.5 Vaults

The United Kingdom experience with dry storage of spent Magnox fuel in vaults is extensive. The initial experience with vaults started in 1957. Three vaults were constructed for storage of Magnox fuel starting in 1962 and have been operating on a commercial basis since 1972. Two additional vaults were licensed and built and have been successfully operating since 1980. Generally, there have been no major operating problems. However, in July 1990, there was a leak of rain water into the vault at Wylfa power station; this led to superficial corrosion of 35 elements and severe corrosion of only 11 out of an inventory of some 21 000 elements [19].

France has a dry storage vault facility for interim storage of canned FBR pins in the Marcoule reprocessing pilot plant (APM). A second facility for stainless steel clad fuel from HWR and material testing reactors named CASCAD has been constructed at Cadarache. This facility is designed for medium-term storage (50 years) of spent fuels for which reprocessing is deleted or not foreseen for technical or economic reasons. Amongst them are HWR fuels from the EL4 reactor and MTR fuels from the Osiris research reactor.

The facility consists essentially of a parallelepiped semi-buried concrete storage room, which contains 319 stainless steel tubes hanging from its roof and which are closed at the bottom. The containered fuels are unloaded from the casks, and put into baskets which are stacked in the tubes. The tubes are plugged with shielded and air-tight plugs and they are equipped with bottom shock absorbers. Air cooling occurs by natural convection outside the tubes (indirect cooling). An emergency forced-air ventilation system equipped with high-efficiency filters is provided in case of air contamination or temperature inversion. The air flow enters the storage room, flows around the storage tubes and is exhausted through a stack. The design basis cooling capacity of the normal convection system is 600 W per tube while the concrete wall temperature does not exceed 80°C. The tubes are monitored for surface temperature and internal contamination. By design the building withstands the maximum safety seism of IX MSK and is subcritical even in case of flooding. This facility started operation in June 1990. Extension of the storage facility is a reserved option.

In Japan, a dry store for about 30 tHM uranium metal spent fuel was brought into operation in 1982; since then no defects or failures of storage canisters have occurred [20].

In the United States, high-temperature gas reactor (HTGR) fuel has been stored in vaults at INEL since 1964. Carolina Power and Light, a utility in the United States, received a licence in August 1986 to operate a vault type dry-storage facility consisting of horizontal concrete modules.

2.6 *Summary of dry storage experience*

Many thousands of spent fuel assemblies of different types have been stored for periods of time ranging from a couple of years to over 40 years in more than 20 different dry storage facilities. In general the spent fuel behaviour during storage has been excellent, with the exception of the in-leakage of rain into a Magnox vault in the United Kingdom which led to only localised corrosion, and no detrimental effects of dry storage on the integrity of the spent fuel have been detected. A few leaking rods have been detected in some demonstration programmes; however the cladding defects had no adverse impact on storage or retrieval of the fuel and the rods may have been defective prior to dry storage.

PWR fuel elements were stored during 15 years in a dry, inert-atmosphere storage cask at the Idaho National Environmental and Engineering Laboratory (INEEL). Fuel burn-up ranged up to 36 GWd/MTU. During this storage period the peak cladding temperature ranged from 150°C to 350°C. The cask was opened to inspect the condition of the fuel rods. No rod breaches were observed, and there was no visible degradation or CRUD/oxide spallation from the fuel rod surface (CRUD stands for Chalk River Unidentified Deposits, from the name of the NPP where these oxide deposits on the Zircaloy cladding were observed for the first time). Thermal creep measurements were made, which indicated that significant creep ductility remains. Overall, no deleterious effects on fuel or cladding were observed after 15 years of dry cask storage [21]. The US Updated programme plan for high-burn-up LWR fuel [22] gives a wide bibliography of the work performed on these subjects.

2.7 *Safety issues for dry storage facilities*

Safety issues addressed by the US NRC in their review of licence applications for metal casks and horizontal concrete modules (vaults) include: the ability of the selected materials to retain integrity in service; shielding design and materials; fuel-basket design and materials, including neutron absorbers; lid design and sealing techniques; cooling duct design (for vaults); design for lifting hardware. Examples of site-specific issues include: storage raft/pad design and safeguards; the detection and correction of leaking cask/container lids; seismic effects on storage pads, vaults, and casks; procedures for loading and transporting casks/containers to the storage pad/vault; the radiation doses received by the workers and the public; maintenance procedures. The safety issues that are unique to concrete dry storage concepts include: the structural strength of the concrete; the ability to decontaminate the external surface of the cask or internal surface of the vault or well; the limited experience with using concrete at high temperatures.

3. **Areas of future work**

The areas of continued research include:

- further collection of data on dry and wet storage experience to confirm the safety of available storage concepts (including experience with consolidated fuel);
- spent fuel monitoring;
- decontamination and cleaning of spent fuel storage, transport and handling facilities;
- storage of defective fuel (growth of defects, impacts on safety);
- long-term storage (100 years or more) in wet and dry storage facilities (extrapolation of present experience, validity of extrapolated data, accelerated tests, etc.);
- development of predictive models for the behaviour of spent fuel during and after interim storage (material aspects, failure mechanisms);

- effect of crud on spent fuel integrity.

A research and development program on long-term subsurface dry interim storage has been recently undertaken in France in the framework of the December 1991 law on the research concerning high level and long-lived waste.

In the United States, following the Updated program plan for high-burn-up LWR fuel [22], work is in progress at Argonne National Laboratory on medium and high-burn-up fuel rods to:

- measure isotopic compositions;
- measure creep rates under storage conditions;
- determine mechanical properties in relation to expected accident conditions.

This information will be used to confirm that acceptance criteria for dry storage are adequate, and to develop acceptance criteria for storage casks and facilities. This work will involve the Zircaloy-2 and 4 alloys, and, when available, Zirlo and M5 alloys.

The future work for long-term storage of spent fuel was discussed in 2003 at a conference involving 35 countries [23]. Technical consensus was reached that present technologies for spent fuel storage provide adequate protection to both people and the environment. Wet and dry storage are considered both to be proven technologies. In light of changes involving higher burn-up, higher initial enrichment, MOX fuel, and modified cladding materials, continued investigative work is necessary. It was noted that on the order of 10 000 tHM spent fuel is unloaded in the world every year, and this should increase to 11 500 tHM by the year 2010. Some national situations may require urgent attention to provide sufficient capacity for long term storage. Some technical and regulatory challenges raised by the long term storage scenario were listed:

- storage durations have been trending upward, and an upper limit of 300 years in some cases may be appropriate;
- specific acceptance criteria, in terms of cladding integrity, should be provided, in light of wet or dry storage, for the storage duration;
- risk assessments of storage systems performance is a growing technology; preliminary results show that there is an extremely low risk associated with dry storage systems. This area should be further developed;
- there is continued interest in the use of dual purpose dry storage (including shipping) in terms of the cask response to accident conditions (possibly involving malevolence);
- overall, there is continued interest in refining the assessment of the impact to the public for the complete transportation scenario;
- all of these topics are of added interest to most countries, taking into account that storage, and not disposal, is the likely situation for spent fuel over the next several decades.

IAEA is planning SPAR-II, a sequel of the “Spent fuel performance assessment and research” study [6].

The United States has issued in 2004 interim guidance for the review of spent fuel storage in dry casks [24]. This guidance is in part related to the points listed above in that it provides acceptance criteria clarification for dry storage. In particular, the following criteria are given:

- the maximum calculated fuel cladding temperature should not exceed 400°C for normal conditions of storage, and for short-term loading operations. (A higher short-term temperature limit for low burn-up fuel may be used, if the cladding hoop stress remains below 90 MPa);

- during loading operations, repeated thermal cycles should be limited to fewer than 10 cycles, with cladding temperature variations that are less than 65°C;
- for off-normal and accident conditions, the maximum cladding temperature should not exceed 570°C.

A general requirement to account for in reactor formation of oxides and hydrides is provided in the context of high burn-up fuel (>45 GWd/tHM): the stress calculations for the integrity of the cladding must take into account all of the relevant factors, including the effects of oxidation and hydriding.

Overall, this Interim Guidance is intended to meet four safety objectives:

- radiation doses from the spent fuel are less than regulatory limits;
- subcriticality is maintained under all credible situations;
- there is adequate confinement and containment of the spent fuel under all credible storage conditions;
- the storage system allows for ready retrieval of the spent fuel.

As noted by the IAEA conference, and as anticipated by the NRC interim guidance document, as spent fuel burn-up increases beyond currently licensed levels, further consideration of the acceptance criteria is indicated. This indicates (as anticipated by the IAEA conference) further evaluation and research into the long term behaviour of fuel and storage components.

4. References

- [1] US NRC (1984), "Waste Confidence Decision", (Nuclear Regulatory Commission) Federal Register, Vol. 49, No. 171, 31 August.
- [2] IAEA (1987), "Behavior of Spent Fuel Assemblies During Extended Storage", Final Report of the Coordinated Research Programme BEFAST, Phase I (1981-86), IAEA-TECDOC-414, Vienna.
- [3] IAEA (1992), "Extended storage of spent fuel", Final report of a Co-ordinated Research Programme on the Behaviour of Spent Fuel and Storage Facility Components During Long Term Storage (BEFAST-II) 1986-1991, IAEA-TECDOC-673, October, Vienna.
- [4] IAEA (1997), *Further analysis of extended storage of spent fuel* (BEFAST-III), IAEA-TECDOC-944, Vienna.
- [5] IAEA (2003), "Spent fuel performance assessment and research" (SPAR, 1997-2001), IAEA-TECDOC-1343, Vienna.
- [6] IAEA (1988), "Survey of Experience with Dry Storage of Spent Fuel and Update of Wet Storage Experience", Technical Reports Series No. 290, Vienna.
- [7] IAEA (1988), "Nuclear Power and Fuel Cycle: Status and Trends", (1988 Edition), Vienna.
- [8] IAEA (1985), "Transport Regulations", Safety Series No. 6, International Atomic Energy Agency, Vienna.

- [9] IAEA (1982), "Advisory Material for the Application of the IAEA Transport Regulations", (Second Edition), Safety Series No. 37, Vienna.
- [10] US NRC, "Licensing Requirement for the storage of Spent Fuel in an Independent Fuel Storage Installation", (Nuclear Regulatory Commission), Rules and Regulations, Title 10, Chapter 1, Code of Federal Regulations, Energy part 72.
- [11] Johnson, A.B. Jr. (1978), "Impacts of Reactor-Induced Defects on Spent Fuel Storage", Proceedings of NEA Seminar on the Storage of Spent Fuel Elements, Madrid, June 1978, OECD/NEA, Paris.
- [12] Wasywich, K.M. (1991), "Examination of used Candu fuel following 27 years of storage under water", RECOD-91, Vol. 1, pp. 371-376.
- [13] US NRC (1979), "Final Generic Environmental Impact Statement on Handling and Storage of Spent Light Water Power Reactor Fuel", (Nuclear Regulatory Commission) NUREG-0575, August.
- [14] GRS-A-59 (1977), "Untersuchungen zum vergleich grosstmoglicher storfallfolgen in einer Wiederaufarbeitungsanlage und in einem Kernkraftwerk", November.
- [15] Bachner, D., Holm, D., Meltzer, A., Morlock, G., Neusser, P. and Urbahn, H. (1979), "Untersuchungen zum Vergleich Grosstmoglicher Storfallfolgen in einer Wiederaufarbeitungsanlage und in einen Kernkraftwerk", Institut fur Reaktorsicherheit, IRS, AB 290, August.
- [16] US NRC (1979), "Spent Fuel Heat-up Following Loss of Water During Storage", (Nuclear Regulatory Commission) NUREG-CR 0649, May.
- [17] Benjamin, A.S. and McGloskey, D.J. (1980), "Spent Fuel Heating Following Loss of Water during Storage", Nuclear Technology, July, Vol. 49, No. 2.
- [18] Collins, T.E. and Hubbard, G. (2001), "Technical Study of Spent Fuel Pool Accident Risk at Decommissioning Nuclear Power Plants", NUREG-1738, February.
- [19] *New Scientist*, No. 1758, March 2, 1991.
- [20] Shirai, E. *et al.* (1991), "Dry storage facility of JRR-3 spent fuels", RECOD-91, Vol. 1, pp. 367-370.
- [21] NUREG (2003), "Examination of Spent PWR Fuel Rods after 15 Years in Dry Storage", Argonne National Laboratory, CR-6831, September.
- [22] US NRC, (2003), "Updated program plan for high-burn-up LWR fuel", 15 August, ADAMS#ML031810103.
- [23] IAEA (2003), "International Conference on Storage of Spent Fuel from Power Reactors", CN-102, June, Vienna.
- [24] US NRC (2004), "Spent Fuel Project Office-Interim Staff Guidance-11, Revision 3", Available on NRC Public Web Site at: <http://www.nrc.gov/reading-rm/doc-collections/isg/isg-11R3.pdf>.

Chapter 7

SAFETY OF FUEL REPROCESSING

1. General considerations

Spent fuel from NPP has been reprocessed on an industrial scale for about 40 years, by separating the recyclable fissile material from the unusable fission products contained with them. The separation technique generally adopted is liquid-liquid extraction, using nitric acid for the aqueous phase and tributyl phosphate (TBP) for the solvent of the organic phase, following the PUREX process [1].

The total quantity of civil and military fuel already reprocessed throughout the world is estimated to be several hundred thousand tonnes of which 80 000 tonnes in Europe.

At the end of 2002, the total quantity of civil fuel reprocessed in OECD countries was approximately 45 000 tHM of metallic fuel (mainly for Magnox and GCR type reactors) and nearly 25 000 tHM of oxide fuel (mainly for light water reactors – LWR).

In France UP1, the first plant built in Marcoule for metallic fuel, operated from 1958 to 1997. It is currently being dismantled after having reprocessed 18 000 tHM. The La Hague site, where the plants UP2-400, UP2-800 and UP3-A are located (Figure 7.1), reprocessed 10 tHM of FBR fuel, 6 000 tHM of metallic fuel between 1966 and 1987, and 18 308 tHM of oxide fuel between 1976 and end of 2002. The capacity of the La Hague site is 1 700 tHM/y of LWR fuel [2].

Figure 7.1. Aerial view of the La Hague UP3-A Plant (Source: COGEMA – France)



In the United Kingdom, the Sellafield site has reprocessed around 40 000 tHM of fuel since 1952 in its different plants: BUTEX, closed in 1964; B205 for Magnox fuel; and THORP for oxide fuel. The total production of THORP, since it came into service in 1994 up to end of March 2003, is 4 00 tHM of British AGR and foreign LWR fuel. The Dounreay plant, which specialised in the reprocessing of civil experimental fuels (research, FBR) was closed down in 1992 [3,4].

In Germany, the Wackersdorf project for a plant reprocessing 350 tHM/y was abandoned in 1989 before the beginning of construction [5]. The WAK pilot plant in Karlsruhe was closed down at the end of 1990.

In Japan the Tokai Reprocessing Plant, a pilot facility in operation since 1977, reprocessed about 1 000 tHM of fuel (by end of October 2003). Its operation was stopped in 1997 because of the bitumen fire event and restarted in 2000 with an annual capacity of 40 tHM of experimental fuel. A plant of industrial size (800 t/year of LWR fuel) is being built in Rokkasho mura. It will be commissioned in 2006.

Civil fuel reprocessing plants and pilots built elsewhere in OECD countries (NFS West Valley in the United States, Eurochemic in Belgium, and Eurex in Italy) have been closed down. Plants are still operating in Russia.

All the installations involved in the fuel cycle are subject to safety regulations specific to each country and are designed, built, operated and decommissioned to comply with these various regulations and conditions. Their design, construction, operation, and decommissioning are generally controlled by authorisation procedures under the appropriate governmental regulatory bodies.

Numerous safety factors have to be taken into account. These can be divided into hazards of nuclear and non-nuclear origin, and non-nuclear hazards may be of internal or external origin.

- Hazards of nuclear origin, connected with the physicochemical characteristics of radioactive materials:
 - dispersion of radioactive materials;
 - external exposure;
 - criticality;
 - consequences of the release of heat;
 - consequences of radiolysis.

Non-nuclear hazards are inherent to every industrial activity, but they may induce nuclear hazards. This category is subdivided into:

- Hazards of internal origin, for situations caused by the operation of the installation:
 - fire;
 - handling faults;
 - internal flooding;
 - internal explosion;
 - consequences of the use of chemical products;
 - consequences of the use of pressurised equipment;
 - consequences of the use of electricity;
 - loss of supply of energy and utilities.

- hazards of external origin, generated by the natural and industrial environment of the installations:
 - earthquakes;
 - accidental plane crashes;
 - severe weather conditions;
 - external flooding;
 - consequences of the presence of industrial environment and transport routes.

Corresponding risks are made acceptable by means of safety functions (the functions whose loss might result in radiological consequences for the personnel or the environment). The first safety function is that of containment. Other functions such as cooling, monitoring, keeping of physical structures and the control of criticality may also be considered.

The potential risk comes from stored and reprocessed radioactive material. One tonne of fuel irradiated in a LWR, cooled for one year, contains about 74×10^6 GBq (2 million curies) of fission products and up to 10 kg of plutonium. The inventory of the process units can represent the equivalent of 5 times the daily capacity of the plant, i.e. 5 to 7 tHM/day corresponding to about 4×10^5 TBq (10 million curies) of fission products and approximately 50 kg of plutonium. Taking into account the decay over the time period, residual thermal power is much lower than in a nuclear power plant.

Compared with the inventories of radioactive material upstream and downstream of the reprocessing plant itself (in spent fuel storage or HLLW storage, for example), the inventory of the process units is relatively low. The risk comes from the fact that during all the stages in the process the material is present in dispersible forms, such as solutions, powders, and gases, and is subjected to physical and chemical reactions. Containment is therefore indispensable for preventing dispersion outside the installation, notably in the event of an accident. The roles of containment and of the off-gas purification circuits of the ventilation systems which complete it are investigated in detail below.

1.1 Hazards of nuclear origin

1.1.1 Dispersion of radioactive material

The principal hazard in reprocessing plants is that of the dispersion of radioactive material: it may result in exposure of the personnel and contamination of the environment.

From the design stage onward, great importance is attached to the interposing of barriers between this material on the one hand, and the personnel, public and environment on the other, in order to reduce this risk. Thus a primary system of containment fulfils this safety function by means of static containment (tanks, pipes, enclosures, and cells), completed by dynamic containment by means of ventilation of the process equipment, vessels, or cells. This enables a flow of air to be created from the potentially less contaminated areas to the potentially more contaminated areas, by keeping the latter at a lower pressure than the adjacent areas. This function is described in more detail below. The primary containment system is not normally accessible to the personnel.

In the event of damage to this first containment system, a second system ensures static and dynamic containment in the areas adjoining those of the first system (working areas and equipment rooms accessible to the personnel).

The number of containment barriers installed depends notably on the evaluation of risks. The primary containment barrier represented by the process equipment and piping, may not be easily accessible for maintenance or repair once the installation is in active operation; the construction materials must therefore be chosen with particular care. A large proportion of the equipment that acts as the primary containment barrier in the reprocessing process is in contact with concentrated nitric acid, often at high temperature. Highly oxidising metallic substances such as plutonium (VI), which augment the corrosiveness of the liquids, may be present in certain areas of the installation. In certain sectors, notably the dissolvers and evaporators, the medium is aggressive and erosion increases the rate of wear of the materials (e.g. the UP3-A shear-dissolver chute). Stainless steels, zirconium, titanium, niobium and tantalum are materials that possess high levels of resistance in this kind of environment. Considerable research has been carried out into their properties in relation to corrosion; several papers relevant to fuel reprocessing have been presented at RECOD conferences [6,7,8,9,10].

Continuous progress has been made in the field of remote maintenance, which has enabled numerous repairs to be carried out on systems in active operation. The integrity of the materials involved in safety is checked during regular inspections using technology such as television cameras, endoscopes, fibre optics, and pressure tests. There is every reason for submitting dissolvers and evaporators to these checks, as they feature pressure vessels for their heating and are exposed to the most aggressive environments, but such inspections are not easily carried out.

It may be necessary to breach the first containment barrier in order to carry out maintenance work. The result is a higher likelihood of exposure to radiation for the workers and of dispersion of radioactivity. One of the main objectives in the design of reprocessing plants is to minimise the need for maintenance, especially in active zones and where there may be a breach of the first containment barrier. Much progress has been made in this field in the more recent facilities. The tendency toward the use of power fluidic technology (notably hydraulic pumps and ventilation valves), more reliable than moving parts, is particularly interesting [11], although not yet widespread.

Many developments have also been made in the manner in which maintenance work is carried out within the primary barrier. This has been through the modular design of equipment enabling the use of remote manipulation or robots and through the use of equipment enabling the barriers to be crossed without breach of containment, with biological protection to limit the exposure of operators. The progress recorded in this domain in the La Hague plants thanks to the use of EMEM-MERC (mobile equipment replacement cask) has been decisive (Figure 7.2).

The reprocessing equipment is almost all contained within cells enclosed in thick concrete walls, constituting the second containment barrier. The external walls of the plant can constitute a third barrier against release into the environment. These barriers must be designed and built in such a way that the containment function will not be significantly impaired either by natural phenomena, however unlikely (flooding, earthquakes, tornadoes, etc.), or by accidental external aggression (such as accidental plane crashes, explosions, projectiles from neighbouring factories, etc.).

The pipes that convey radioactive liquids from one building to another may represent a weak point in the containment system. These pipes are often raised off the ground, on racks, or below ground level, in trenches or covered channels. Some countries have introduced standards; for example, overhead pipes on racks are generally required to have a double casing to ensure containment on two levels, whereas underground channels must be leak-proof to provide a second containment barrier. Appropriate monitoring and leak-detection systems can then be used to limit any environmental impact.

Figure 7.2. EMEM (mobile equipment replacement cask) in the AD2 facility at La Hague
(Source: COGEMA – France)



As already observed, static containment barriers are complemented by the dynamic containment of ventilation systems. There are several such systems in a reprocessing plant, each one designed for a specific function:

- The dissolver off-gas venting systems (DOG) are designed to process hot, humid gases that enter into or result from the dissolving process. They may be designed to extract iodine, carbon isotopes (as in the THORP plant), radioactive aerosols and other volatile or gaseous substances such as nitrogen oxides. Preference is generally given to scrubbers, chemical absorbents, and HEPA filters.
- The process vessel ventilation systems are required to treat moist off-gases which, although less humid than in the DOG, may also carry active particles. In general dehumidifiers and filters are used in these cases.
- Cell ventilation circuits are designed for large volumes of relatively dry air at ambient temperature, with a low radioactive content. The use of filters is generally sufficient.
- Building ventilation systems are also designed to control the characteristics of the atmosphere to ensure an adequate working environment; rates of airflow are often high and a humidifier may be installed at the inlet.

The correct functioning of all ventilation systems is decisive in limiting the consequences of any discharge of radioactivity into the environment, whether accidental or resulting from normal process operations. These systems must have sufficiently high levels of redundancy and reliability, and they must be subject to regular operational tests, especially to check the efficiency of the filters.

1.1.2 External exposure

External exposure is mainly due to gamma and neutron radiation, with a smaller proportion of alpha and beta radiation. From designing the plants onward, emphasis is placed on limiting the level of radiation exposure to personnel by:

- designing working stations as far away from radioactive material as possible;
- installing protection adapted to the nature and energy of the radiation emitted;
- limiting the exposure time of the personnel.

1.1.3 Criticality

Insofar as fissile material is manipulated in numerous different zones inside a reprocessing plant, there must be measures of protection against criticality excursions. Section 4-2 deals with criticality prevention in general, whereas the aspects that apply to reprocessing are examined below.

Among the prevention measures is the use of geometrically safe equipment; this takes into account all the possible concentrations of fissile material that could result either from normal operation or from dysfunctions in order to ensure that reactivity cannot reach a level that would lead to a criticality excursion. If this results in equipment of excessively small dimensions, neutron absorbers such as gadolinium, hafnium, and boron (either in the form of solids or soluble poisons) can be used to reduce reactivity. The following measures all play a part in criticality prevention in reprocessing plants:

➤ Control of the mass

The total mass of fissile material in a tank or any given part of the installation is limited to such an extent that the likelihood of criticality is nil, no matter how the fissile material may be arranged. This method applies to solid material.

➤ Control of the volume

This applies principally to liquids. If a tank or given part of the installation contains a total volume lower than the critical volume of a chemical compound containing fissile isotopes (taking into account the possibility of blockage or overflowing), the likelihood of criticality is nil. The use of these first two methods may require the construction of unacceptably small installations, in which case one of the two following methods will have to be used.

➤ Control of the concentration

This applies to liquid solutions with a relatively low concentration of fissile matters. For each tank, pipe, or other part of the installation, it is easy to calculate the critical concentration threshold. It is sometimes necessary to monitor numerous variables in the process, including those of non-fissile material, to verify that the concentration thresholds will not be exceeded. In-line instrumentation is often needed to monitor the concentrations and profiles of fissile material and to detect undesirable accumulations.

➤ Geometric control

This type of control covers a range of techniques. It consists mainly in limiting the physical dimensions of components of the process equipment, thereby excluding any criticality for all possible variations in concentration, position, or chemical form of the fissile material anticipated for the

selected process. The dimensional limits are usually calculated on the basis of an infinite cylinder or plate, for which the surface to volume ratio is high, thus facilitating neutron leakage. This method is particularly suitable for reprocessing material with a high fissile material content.

There are six main areas in which it is imperative to take criticality risks into account:

➤ Shear pack

Any accumulation of spent fuel powder, which might lead to criticality in the event of accidental moderation, must be avoided. In-place decontamination may have to be carried out before an intervention on the shearing machine. If wet cleaning is required, it may be necessary to integrate a neutron poison into the cleaning liquid.

➤ Dissolver

The criticality safety of the dissolver depends on the geometric safety of the basket (Figure 7.3) and/or on the addition of a soluble neutron poison to the nitric acid solution. Burn-up credit is only taken into account if it can be monitored up line in the process feed, and this enables the increase of the typical dimension of equipment destined for industrial flow rates. If a soluble neutron poison is used, it is important to monitor the quantities added using two different and independent methods.

Figure 7.3. View of the wheel of the dissolver used in UP2-800 and UP3-A
(Source: COGEMA – France)

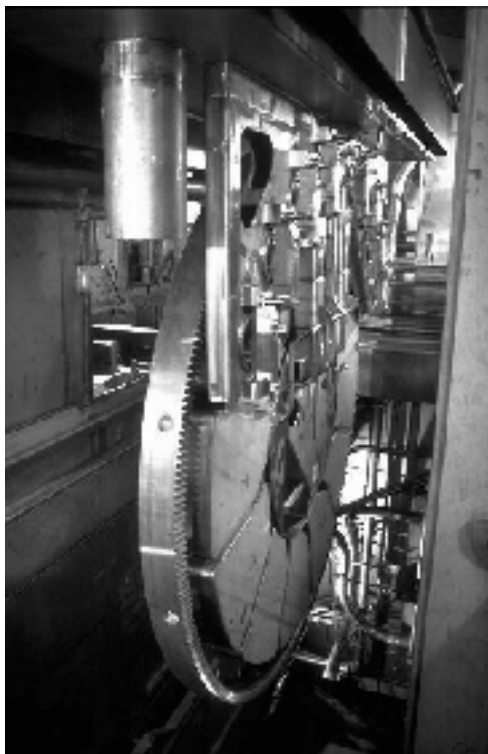

➤ Storage of hulls

The quantity of residual uranium and plutonium present in fuel hulls after dissolution must be measured for criticality prevention and, with a higher precision, for accounting purposes, before being

transported to the storage facility. Monitors select the energies of the specific gamma rays of certain isotopes, such as ^{144}Ce and promethium. These techniques have given satisfactory results in Sellafield (United Kingdom), in West Valley (Nuclear Fuel Services, United States) and in La Hague (France). Other techniques exist, based on the principle of passive or active neutron interrogation. These techniques, which guarantee the criticality safety of storage, are also used in the La Hague facilities.

➤ Solvent extraction process

The design objective must be to provide a safe geometry for the extractors. If this is not possible, concentrations of uranium and plutonium must be monitored and the conditions that might lead to a build-up in these concentrations must be prevented from occurring. The required flow rate and quality of each reagent must be defined; they must then be precisely measured and analysed in situ. The profile of uranium and plutonium concentrations in each extractor must be carefully monitored and all the equipment must be subjected to regular surveillance to avoid the accumulation of fissile material.

➤ Purification of uranium and the production of oxide

In installations that process uranyl nitrate solutions, if ^{235}U enrichment is controlled to be less than 2%, criticality safety can be ensured without further restriction; if the enrichment is greater than 2%, the concentration must be controlled. Geometric control can be used for oxide conversion equipment; a combination of geometry and moderation control (by considering an envelope water content) must be used for oxide storage installations.

➤ Purification of plutonium and the production of oxide

A minimum ^{240}Pu content (isotope that absorbs neutrons, the concentration of which increases with the burn-up) in the material used during the process is taken into consideration. This enables the dimensions of equipment to be increased.

In wet process purification, it is important to make use of risk assessment and failure analysis to evaluate the probable concentrations of plutonium in this part of the installation. In particular, the conditions that might lead to recycling of plutonium and its accumulation in the extractors should be determined in order to prevent this from occurring. Maximum concentrations of plutonium in excess of load diagram levels may be recorded locally, from untimely variations in temperature or acidity, for example [12]. Plutonium in solution can display a tendency to form a colloid that plates out and settles on the surface of the equipment if acidity falls below a certain level, which is itself a function of the concentration in plutonium [13,14]. These malfunctions, if not controlled, might lead to an increase in doses and heighten the risk of a criticality incident. Precise evaluations of operating conditions, control of the temperature, and the preservation of minimum levels of acidity all contribute to preventing the occurrence of the failure scenarios described above.

For the production and conditioning of oxide in solid form, prevention of criticality consists essentially of geometric control (cylindrical containers of limited diameter with a minimum distance maintained between the cylinders).

1.1.4 Hazards connected with production of heat

All radioactive material gives off energy that must be removed to avoid an excessive rise in temperature, which might lead to a dispersion of radioactive material or damage the material and equipment that fulfils safety functions.

To minimise this risk, on the basis of the worst-case scenario, the design has to:

- choose material and equipment that retain required integrity under operating conditions;
- ensure that the thermal energy emitted by the radioactive material is removed by active or passive (natural convection) cooling systems by adequately designing the dimensions, redundancy, reliability, and maintainability of the cooling systems.

In practice, the activity and production of heat per unit volume of material throughout the different stages of reprocessing are generally low, and increases in temperature in the absence of cooling would be slow. Strong rises in temperature could only occur in zones where the fission products or fissile material are concentrated, for example, in the centrifugal decantation bowls of the clarification system or in the high-level concentrated liquid waste storage tanks, which are consequently designed in accordance with the principles described above.

1.1.5 Hazards connected with radiolysis

Water and organic material decompose under the effects of radiation. This is the phenomenon of radiolysis, the main result of which is the production of hydrogen, which presents a potential for fire or explosion when it exceeds certain levels of concentration in the air.

This danger is particularly present in solutions containing plutonium and fission products. Diluting the hydrogen generated, using a venting system, prevents it.

1.2 Non-nuclear hazards of internal origin

1.2.1 Fire hazards

A large fire spreading through a reprocessing plant might be one of the main vectors of dispersion of radioactive material into the environment, notably in the event of ventilation system failure, damage to engineered controls or introduction of common mode failure between protective systems and the impossibility of containing the fire within the buildings involved. Reprocessing plants use flammable solvents and certain pyrophoric materials. In addition, the chemical process involves the use of agents with oxidising and reducing properties. The safety analysis of installations and the analysis of incidents must take into account all the potential mechanisms of fire and explosion in order to minimise these risks.

The risk of fire can be reduced by eliminating sources of ignition and hot points and by installing fire detection and extinction systems. Extinguishing agents must be compatible with the equipment and materials affected by the fire and with the subsequent cleaning operations. Inerting gas can be injected into cells, but this may over-pressurise the cell and cause out-leaks; oxygen starvation by sealing the cell may therefore be a better alternative in such cases. For more detailed information about potential fires (or explosions) and their prevention, see Proceedings of the CSNI Specialist Meeting on Interaction of Fire and Explosions [15] and IAEA Symposium on Fire Protection [16].

Nuclear fuel and its cladding may, in certain cases, catch fire during head end processing. Several combustible materials may be used during tail end processing. The PUREX process, moreover, requires a diluent to carry the TBP through the different stages of extraction, and this is almost always a flammable solvent such as kerosene or dodecane, with flash-point around 60-70°C. In certain circumstances, it can be ignited even with a bulk temperature below the flash-point if the local temperature is itself above this flash-point [17]. Hydrogen can be used as a reducing agent on an

industrial scale, and it also appears as a systematic by-product of radiolysis in parts of the process: its concentration must be limited to values below the ignition threshold.

1.2.2 Hazards connected with handling

During handling operations, the loads may suffer shocks, deformation, crushing, or dropping due to failure of handling equipment, derailment of a transporting unit, collision with an obstacle, or poor gripping. These events may have direct or indirect radiological consequences:

- if the load contains radioactive material;
- if the load damages part of the safety system of the installation (damage to containment barriers, to equipment fulfilling a safety function, etc.).

The reliability of the handling systems involved (for example gantries, cranes, remote manipulators) must be ensured by appropriate specifications, design, and standards as well as a programme of tests and in-service inspections.

1.2.3 Hazard of internal flooding

Internal flooding is connected with the presence of fluids in the pipes and tanks of facilities in every industrial installation: cooling water, heating water, treated water, chemical solutions, fire fighting water, etc. In nuclear fuel reprocessing plants, the most important direct hazards generated by flooding are:

- criticality caused by the presence of hydrogenated liquid in areas containing fissile material;
- damage to equipment fulfilling safety functions;
- dispersion into the environment of radioactive material transported by the fluid involved.

1.2.4 Hazard of internal explosion

Explosion is a phenomenon during which pressurised gases are produced in a very short period of time. This phenomenon can be accompanied by a shockwave if a deflagration occurs. In reprocessing plants, an explosion may lead, directly or indirectly, to the dispersion of radioactive material within the installation and into the environment through damage to containment barriers or other safety related systems.

The accumulation of flammable powder, gas, or vapour may lead to an explosion. The risk of explosion linked to flammable substances can be reduced by implementing various measures: preventing the accumulation of flammable air/gas mixtures, elimination of sources of ignition, the operation of installations at a temperature below the flash-point of solvents or other critical temperatures, and the introduction of appropriate detection and monitoring systems. Hydrogen gas probably represents the greatest potential cause of explosion, due to its rapid rate of diffusion, its low ignition energy input, and the wide range of concentration limits that may give rise to an explosion. In 1983, for example, the Dounreay plant in the United Kingdom had recorded three explosions over 26 years, all three caused by hydrogen [18].

However, other explosive mechanisms also exist. These are generally exothermic chemical reactions, with reaction runaway, which may occur in the process when definite conditions are met. In order for a process to be designed and operated in safe conditions, it is essential to have a thorough

prior knowledge of these mechanisms and their determining factors. Three such reactions, described in more detail below, are:

- the explosive combustion of zirconium powder;
- the decomposition of hydrazoic acid;
- the reaction of solvent (“red oil”) with nitric acid.

The following are also possible generators of violent chemical reactions:

- the production of hydrogen by radiolysis;
- the oxidation of U(IV);
- the use of reducing agents (hydrazine, etc.);
- the use of solvents and diluents;
- the use of formaldehyde;
- the presence of nitrites in resins and bitumen.

1.2.5 Hazards connected with the use of chemical products

Apart from fire and explosion described above, the usual hazards associated with the use or presence of chemical products are mainly:

- toxicity for the personnel and the environment;
- corrosion.

A chemical product may be a source of danger either through contact or by inhalation of its vapours. The usual arrangements, most of which come from general regulatory requirements, are taken to deal with these risks.

1.2.6 Hazards connected with the use of pressurised equipment

Essentially, as with any classic industry, this hazard is linked with the potential failure of equipment using steam, superheated water, or compressed gases (air, oxygen, nitrogen, hydrogen, etc.).

Projectiles or streams of fluid resulting from the failure of such equipment or from the degradation of circuits may have consequences for personnel and for the safety of installations, notably in the event of shock or overheating of equipment fulfilling a safety function.

1.2.7 Hazards connected with the use of electricity

Besides the usual risks, the risks connected with the use of electricity are fire and explosion, which are described above. Here again, the application of usual, mostly regulatory, arrangements is the determining factor in reducing these risks.

1.2.8 Hazards connected with the loss of supply of energy and utilities

Like any other industrial installation, reprocessing plants use different utilities in their operation: electricity, water, compressed air, steam, etc.

A prolonged loss in the supply of certain of these utilities may have consequences for the operation of equipment fulfilling safety functions or alarm and monitoring functions. The appropriate arrangements (redundancy, replacement, etc.) can be taken once a detailed analysis of requirements has been carried out.

1.3 *Non-nuclear hazards of external origin*

External hazards may originate in the natural or industrial environment of installations. Unlike hazards of internal origin, it is not always possible to act on the cause of events; the safety of installations is therefore based essentially on controlling the consequences.

The safety of an installation in relation to these hazards is first examined during the design stage, often within the framework of risk assessment surveys using HAZOP surveys or other methods. It is essential to have access to exhaustive databases that can enable the probable frequency of a given external event to be calculated, in order to quantify the potential risk. Such databases are becoming ever more widespread and relevant insofar as operators throughout the whole world are accumulating data to support safety surveys for new power stations or new projects.

It is essential to examine these external events at an early stage in the design of a plant, as they can have a major influence on the location, design, and civil engineering of the plant.

1.3.1 *Earthquakes*

An earthquake is characterised by:

- Its magnitude: the energy released at its epicentre. The Richter open scale is used to quantify the magnitude.
- Its intensity on the site concerned: measuring the impact on and damage to man and his environment. The scale used for this measure is the MSK scale, which has 12 levels.
- Its spectrum, either conventional (NRC type) or derived from actual measurements.

Besides the damage it may cause to buildings, an earthquake may cause the loss of safety functions, either by direct destruction of the equipment fulfilling safety functions or by generating projectiles capable of causing the loss of these functions.

The choice of the design earthquake for installations and equipment takes place in two stages, if it has not been defined *a priori*:

- the first stage consists of analysing past earthquakes on the basis of historical data and geological surveys; this enables the maximum historically probable earthquake (MHPE) to be defined;
- the second defines, by an increase of the level, the intensity of the safety earthquake, SE, that corresponds to the hypothetical maximum situation.

Using the SE for the design basis of installations ensures that safety functions will continue operating in the hypothetical event of such an earthquake. Possible use of the MHPE as the design basis for operational equipment enables operations to continue without verification in the event of such an occurrence.

1.3.2 *Accidental plane crashes*

A plane accidentally crashing into one of the facilities of a reprocessing-recycling plant might have unacceptable consequences for the environment.

In France, aircraft traffic is divided into three categories:

- military;
- commercial (airlines, airmail planes, etc.);
- general: small planes of less than 5.7 tonnes.

This risk is analysed by probability analysis. Taking into account the organisation of air space, the nature of flights (military, commercial, or general aviation) and known accident statistics, it is possible to define, for a given site, the reference aircraft, the probability per square meter of its crash, and the crash trajectories.

Only sensitive surfaces are considered, i.e. those on which the impact might have significant consequences and which are not protected by shields thick enough to withstand the defined design-basis projectile.

In practice, in France, almost all nuclear installations are located away from commercial air corridors and military aviation activities. They are therefore only designed for the impact of general aviation aircraft, such as a Cessna 210 or Learjet.

In the La Hague site the sensitive surfaces are of such a small area, owing to the biological protection shields, that no additional design arrangements are necessary. Moreover, the concrete biological protection of the high-level areas is often much thicker than the minimum thickness necessary for withstanding the impact of a Learjet.

In other countries, where the density of air traffic is much greater, the possibility of an accidental plane crash is taken into consideration a priori. This is the case in Germany and Japan, where the impact of military planes is systematically taken into account.

The impact of a large plane crash has usually not been taken into account in the design basis. The safety consequences for the nuclear installation depend on numerous parameters besides the weight of the plane. Most nuclear installations, even if they have not been designed and built to withstand an impact of this nature without some damage, possess a good capacity of resistance, thanks notably to their containment enclosures made of heavily reinforced concrete.

1.3.3 *Severe weather conditions*

Extreme climatic conditions (heat, rain, wind, lightning, cold, frost, snow) can affect certain safety functions of the installation: ventilation, cooling, fire extinguishing systems, etc.

Most of the equipment is situated inside very robust buildings. The impact of unfavourable weather conditions on their operation is therefore extremely limited. However, certain equipment situated outside the buildings may be affected by extreme climatic conditions, for example:

- the wind resistance of chimneys;
- the resistance of structures against heavy snowfall;
- the frost-resistance of piping, ducts, or air coolers;

- access for emergency services (firemen, staff, etc.).

Extreme weather conditions are consequently taken into consideration in the design basis of installations and in the provisions made for operation.

1.3.4 External flooding

Flooding of buildings in reprocessing plants may be caused by rain falls, a rise in ground water levels, tsunamis or river floods.

Flooding in the buildings can be prevented by appropriate choices of the level of implantation of buildings and measures involving waterproofing, drainage, and ground water lowering.

1.3.5 Hazards connected with the industrial environment and transport routes

Hazards connected with the industrial environment and transport routes are due to the proximity to the installation of:

- chemical, petrochemical industries, etc.;
- oil pipelines, gas pipelines, etc.;
- routes used to transport explosive materials (road, rail, river, or sea traffic).

An explosion may generate an air pressure wave, a seismic wave, or the emission of projectiles capable of affecting equipment fulfilling safety functions.

An analysis of the industrial environment must, therefore, be carried out at the design stage, and permanent monitoring must be implemented when the plant is in operation.

2. Reprocessing of Magnox and alloy fuels

2.1 Criticality

Insofar as Magnox fuel uses natural uranium, criticality problems are much less serious than those encountered with other enriched uranium fuels. Consequently, general mass control in the decladding cells is sufficient; the dissolver can have a large capacity if necessary. For plutonium cycles, however, geometrical control is required, since the concentration of fissile material is higher and there is a potential for accidental over-concentration.

Fuels from irradiation or research reactors are mainly HEU alloys, generally alloyed with aluminium and with aluminium cladding. These fuels are usually totally dissolved in nitric acid, using a mercury catalyst for example, by batches, and in this case criticality control by mass-limitation is essential. The dissolver liquors are then transferred to the next stage in the process, where, as described above, the concentration is verified to maintain safe conditions (Section 7-1.1.3).

2.2 Fire

Fire hazards connected with the use of solvents and radiolytic hydrogen are common to the reprocessing of all types of fuel using the PUREX process. Papers on fire hazards and protection in

general are in [15] and [16]. Magnox fuels, however, present a specific problem: that of the potential for combustion of the magnesium cladding and of the uranium during the decladding process and during handling of the resulting fuel rods up to the moment when the fuel is introduced into the dissolver.

Irradiation in the reactor may cause external porous zones to appear on certain elements. Moreover, uranium metal in contact with pool water (if the cladding is damaged or perforated by corrosion) will form uranium hydride. This is an unstable compound with a strong tendency to ignite when it is dry and submitted to a mechanical shock. The decladding process itself or the shock of a hydrated unclad element may be enough to ignite the hydride. There is then a potential for a spread of the fire, especially if the uranium is porous, and this may cause up to an entire element to burn-up in a large fire, as the uranium metal will itself burn in air if it is hot enough or finely divided.

Likewise, the presence of hydride remaining on Magnox fuel waste may cause the cladding to ignite. Occurrences of this type of fire have been recorded in the decladding cells in Sellafield and La Hague [19]. Fire detection and extinguishing systems are installed as the primary safeguards to minimise the consequences of any ignition.

2.3 Corrosion

The use of ferrous sulphamate in the Magnox fuel reprocessing process in the United Kingdom increases corrosion in certain equipment, while limiting the potential for reducing the volume of aqueous waste by evaporation.

2.4 General

In 1986, the UK HSE carried out a safety audit of the Sellafield reprocessing plant. The results of this audit, which was focussed on the oldest installations (20 to 30 years), give a useful overall view of the safety of fuel reprocessing in general and of Magnox fuel reprocessing in particular [20].

3. Reprocessing of uranium oxide fuels

3.1 Current situation

Uranium oxide reactors are mainly used in light water reactors (LWR), pressurised water reactors (PWR), boiling water reactors (BWR), AGR, advanced thermal reactors (ATR) and HWR (such as CANDU).

Reprocessing of spent oxide fuel started in 1966, and at the end of 2002 about 25 000 tHM had been reprocessed, mainly in the three plants UP2 and UP3-A in France and THORP in the United Kingdom. Table 7.1 gives more precise data.

Given the experience acquired in fuel reprocessing during the 70s, and to meet the growing demand for reprocessing facilities, the decision was made in the late 70s to construct large-scale plants capable of reprocessing national and foreign fuels. A detailed list of these plants is given in Appendix 1.

Table 7.1 Oxide fuel reprocessing statistics

Plant	Operational period	Total production (tHM)
NFS West Valley (United States)	1966 to 1972	262
La Hague UP2 and UP3-A (France)	1976 to end of 2002 (going on)	18 317
Tokai Reprocessing Plant (Japan)	1977 to end of December 2003 (going on)	1 023
Karlsruhe (Germany)	1971 to 1990	208
Eurochemic (Belgium)	1966 to 1974	180
Sellafield (United Kingdom)	before 1973	100
THORP (United Kingdom)	1994 to end of March 2003 (going on)	4 400
Total (Approximate, dates are not consistent)		24 490

The plants that came into service in the 90s are now fully operational. They are constantly being optimised and adapted to new commercial and environmental requirements. The annual capacity available to electricity companies using oxide fuel is currently 2 700 tHM. It will rise to 3 500 tHM in 2006 after the Rokkasho Reprocessing Plant's completion.

The enrichment ratio, the burn-up, and the cooling time of spent fuels can vary considerably depending on the type of reactor from which it comes. Economic requirements are leading to a steady increase in the initial enrichment of the uranium (up to ratios on the order of 5%) to achieve longer cycles in the reactor and, consequently, higher burn-up (which can reach 75 000 MWd/tHM).

In terms of safety, these developments mainly concern the neutron emission, thermal power of the fuel and control of criticality, without creating any new problems; they thus require modifications in the operating conditions of installations to maintain their safety levels.

As far as criticality is concerned, it should be noted that the reactivity of spent fuel varies little, whatever the initial enrichment ratio (the length of the cycle increases in proportion to any increase in the initial enrichment ratio, resulting in an equivalent level of depletion of the fissile material). This explains the increasing tendency of operators to take burn-up credit into account, i.e. to consider the actual reactivity of the fuel rather than its reactivity before irradiation, for this latter would severely restrict the capacity and therefore the economy of facilities [21,22]. Given the double-contingency principle generally implemented in criticality safety, this necessitates a double determination of the actual state of the fuel, one of which may be based on a record of the life of the fuel element in the reactor, established according to recognised quality assurance procedures, the other on actual measurement. These determinations are based on important R&D programmes, both for the validation of measuring equipment and programmes of interpretation of the measurements and for the definition of the limits suitable for controlling criticality.

3.2 *Safety analysis*

The safety aspects of uranium metal fuel reprocessing and uranium oxide fuel reprocessing display several marked differences that are due to:

- the nature of the cladding material (mainly Zircaloy instead of magnesium or Magnox alloy);
- the chemical form of the uranium (oxide instead of metal or alloy);
- the higher burn-up of oxide fuel.

Unlike magnesium or Magnox alloy, Zircaloy cladding is not corroded by pool water. Consequently, the cooling time of spent fuel can be extended to several years or decades, which enables considerable radioactive decay to take place (notably for ^{131}I and ^{106}Ru). On the other hand, particles of Zircaloy (called “fines”) that are generated during reprocessing can increase the potential for fire and explosion.

Because of the higher burn-up of oxide fuel, a markedly greater quantity of fission products is produced (although this is mitigated by the longer cooling time) as well as plutonium and other alpha emitters. Solvent deterioration, hydrazine consumption, and the potential for criticality, exposure, and contamination are all higher.

3.2.1 Investigation of head-end operations

The reprocessing of fuel from LWRs presents practically no fire hazard connected with the pyrophoric properties of plutonium and uranium metals, as these are present in oxide form. However, Zircaloy debris or dust constitute a potential for fire or explosion in plants reprocessing this fuel.

The fragmentation of LWR fuel elements by shearing of fuel assemblies during head-end processing produces fine particles of Zircaloy. These particles may present a potential for ignition of the layers of dust that accumulate in certain zones of the installation, or of dust explosion when they are lifted up by air movements (casing of shearing machine, dissolver, and centrifuge or filter).

A assessment programme relative to this risk sponsored by the CEC and the Federal Ministry of Research and Technology has been carried out in Germany [23].

A systematic survey of the fire and explosion risks of Zircaloy fines has been published in [24]. This quantifies the parameters of ignition. Irradiated Zircaloy fines have a bulk density of about 2.4 g/cm^3 , a specific surface area of $0.1 \text{ m}^2/\text{g}$, a self-ignition temperature of 160 to 210°C , and a glow temperature of 230 to 260°C .

Powdered dust with a grain structure of about $3 \mu\text{m}$ that is carried up into the air can explode at ambient temperature and in the presence of oxygen in concentrations much lower than 5%. The ignition temperature is, however, inversely proportional to the specific surface of the Zircaloy dust; it decreases as the size of the grains decreases. For dust particles with a diameter of around $18 \mu\text{m}$, this temperature is 360°C [24]. Gaseous nitrogen does not react with Zircaloy fines, which present absolutely no reactivity under water.

Grain structure distribution demonstrates that shearing produces very few fines of less than $100 \mu\text{m}$. Moreover, large quantities of UO_2 dust, with its high inerting capacity, dilute the Zircaloy particles by a factor of between 10 and 100 in the shearing machine, thus preventing the ignition of the dust cloud, according to [25] that concludes, as do systematic studies carried out by KfK [24], that the fire and explosive potential of Zircaloy fines is relatively low in normal operating conditions, because of the dilution of the fines by UO_2 powder.

It would appear that the absence of any recorded Zircaloy fines explosions during the shearing can be imputed to the practical existence of these two conditions. In any case, dust clouds are inevitable in the shearing chute, and a reduction in the accumulation of Zircaloy fines to below several hundred grams must be aimed for from the design stage onwards. If this is not possible, nitrogen inerting must be planned to prevent the conditions likely to cause an incident during shearing. The

shearing machines in the La Hague site have been designed to prevent these accumulations, and they are, in addition, ventilated with nitrogen.

3.2.1.1 Dissolution

The formation of dust clouds is very unlikely, except in the shearing chutes where the potential for ignition cannot be totally excluded. Ignition phenomena remain negligible as long as the quantity of fines is limited. Quantitative hypotheses must be drawn up for the safety cases, and it must be possible to carry out inspection and elimination of particle accumulations within the required safety conditions.

3.2.1.2 Clarification

Zircaloy powders and insoluble residues (inclusions composed of ruthenium, rhodium, palladium, and insoluble fission product compounds of molybdenum, tin, antimony, zirconium, and niobium) are separated from the feeding solution of the liquid extraction process to prevent any clogging or interface fouling. This process is known as clarification.

As an example, 3 to 5 kg of residue is collected per tonne of LWR fuel irradiated at 33 000 MWd/tHM. The radioactivity of this residue is still very high three years after unloading from the reactor.

Spontaneous exothermic reactions between Zircaloy and some oxides of fission products such as MoO_3 can be detected during calorimetric experiments, following a rapid increase in temperature. In practice, self-heating is slow and cannot produce a violent reaction.

In conclusion, each specific safety case can only be drawn up after precise evaluation of design specifications, and may therefore vary from one plant to another. Appropriate evaluation and design combined with operating precautions enable incidents of this kind to be avoided.

3.2.2 *Investigation of solvent extraction operations*

3.2.2.1 Solvent fire hazards

An inventory of all areas in the installation where the quantity of solvent present is sufficient to cause significant likelihood of fire must be drawn up, and the following general precautions should be taken:

- The solvent is generally maintained below its flash point temperature (70°C) during all stages of the process. Normal operating temperatures vary between 30 and 60°C.
- The installation has no identifiable source of ignition. As far as possible, the solvent is confined in leak-proof process equipment and the electrical equipment of the cells, for example, has reinforced protection (encapsulation).
- Where there may be local temperature rises, in the steam ejectors for example, the atmosphere is composed mainly of steam and does not favour combustion. In certain cases nitrogen inerting is used.

For fire to break out in a cell, it would be necessary for some kind of failure to cause the solvent temperature to rise above flash point, for the primary containment to be breached, for a sufficient

quantity of solvent to accumulate in the cell to present a significant potential for fire, and lastly, for there to be a source of ignition. The frequency of an internal cell fire has been evaluated, according to calculations, at less than 10^{-6} per year, and this type of incident has never yet been recorded.

The possible consequences of a solvent fire in a cell have been quantified in a study [26] and can be summarised as follows:

- The mechanism is that of a relatively fast primary combustion during which the air present in the cell is used up. The fire then either goes out and starts up again when a sufficient quantity of new air has entered the cell, or decreases from the primary combustion speed to a much lower combustion speed limited by the air intake rate (secondary combustion).
- The extraction of air by the cell ventilation system is taken into account when calculating the degree of pressurisation of the cell. These calculations enable determination of the quantity of air escaping from the cell during the primary combustion and the quantity of radioactivity released. The discharge of air and its dispersion in the environment are used as the basis for calculating the dose absorbed and the resulting impact.
- The consequences of secondary combustion where the fire is fed with air by the leakage rate of the involved zone, without taking into account any fire-fighting action, appear to demonstrate that the potential external consequences of a solvent fire remain below the criteria for taking such an accident into account. Nevertheless, it appears that rules of good practice require that all cells containing a significant quantity of solvent should be equipped with fire-fighting systems. The preferred extinguishing agents are foams and inhibiting gases.
- The benefit of fire-fighting systems appears to be limited to reducing the consequences of secondary combustion. Consequently, the risk of solvent fire in cells can be considered as being always mastered.

3.2.2.2 Decomposition of solvents and chemical reducing agents

The radiolysis of the solvent during reprocessing generates products, such as dibutyl phosphate, which form compounds with heavy metals (red oils). The decomposition of these compounds can be explosive. This is taken into consideration in the evaporators by improving the separation of the solvent from the solutions fed into the evaporator and by limiting the temperature of the evaporator walls (to 135°C, for example).

The presence of denitration reagents, such as formaldehyde, may constitute an explosive source in the evaporators if the parameters of the reaction are not controlled.

In the La Hague plants as well as in the THORP plant in Sellafield, tetravalent uranium is produced by catalytic reduction of a solution of uranyl nitrate with pressurised hydrogen gas. The excess hydrogen is then separated from the uranium (IV) nitrate. The main risk associated with this operation is the explosion of hydrogen. The preventive measures used include a hydrogen detection and alarm system, the automatic closing of the hydrogen supply when a leak is detected, and a redundant ventilation system designed to maintain the concentration of hydrogen in the cell below the ignition threshold.

The process cells are isolated and separated from the rest of the reprocessing plant to prevent any accident that may occur in the uranium (IV) facilities from having any nuclear consequences. Moreover, the equipment and cells are designed to withstand any explosion in order to limit the consequences (blow-out roof or panel).

The rate of formation of radiolytic hydrogen increases in proportion to the radioactivity of the solutions of fission products and plutonium. Consequently, to eliminate any potential for explosion, the tanks are ventilated, either by direct air injection into the plenum or by bubbling to reduce the concentration of hydrogen in the air to less than 4%.

3.2.2.3 Explosion hazards

In 1962, a reduction of plutonium by uranium (IV), with an excess of hydrazine acting as both stabilising reducing agent and nitrite eliminator, was introduced in the PUREX process in the United States. The oxidation of the hydrazine by nitrous acid or nitrates in the presence of technetium (fission product of the spent fuel) acting as a catalyst leads to the formation of hydrazoic acid HN_3 as an intermediate product.

The possible sources of an explosion during reprocessing come from the decomposition products of hydrazine, hydrazoic acid, and nitrates, the formation of which depends, amongst other things, on the concentration of technetium and the flow of plutonium.

Hydrazoic acid, which is soluble in the solvent, is re-extracted by the alkaline solution in which the sodium nitrate accumulates. The alkaline solution is neutralised. It becomes acid when mixed with concentrated high-level solutions and free HN_3 may be produced, possibly accompanied by an explosion in the vitrification facility. To prevent this, hydrazoic acid is destroyed beforehand, by nitrous acid or an excess of nitrite for example.

The potential for explosion of HN_3 has led to the definition of a very prudent concentration limit of 0.05 mole of HN_3 per litre for solutions used in the PUREX process [27], but solutions of a concentration much higher than 0.05 M can be used safely. Experience has shown that no HN_3 explosion has ever occurred in reprocessing plants. A critical assessment of this safety standard has been published in Germany based on the systematic analysis of HN_3 in the solutions of the process used in the WAK installation in Karlsruhe [28]. The results confirm that HN_3 does not reach dangerous levels of concentration in the stream of the PUREX process.

3.2.3 Criticality

Criticality events can be caused by an accumulation of fissile material in non-conformance to specifications or by operator errors such as the unexpected transfer of process solutions.

The implementation of appropriate geometric controls, combined with the judicious use of neutron absorbers and reliable systems for monitoring the fissile material are no doubt largely responsible for the fact that no criticality accident has yet been recorded in the main process of fuel reprocessing facilities, whether the fuel comes from LWR or other types of reactor.

More precisely, the following provisions may be taken against criticality excursions:

- geometrical restriction of the dimensions of components to exclude any criticality, based on the normal concentration of fissile material present in the process increased by an additional margin of safety;
- for certain components that would be too small if this principle were applied, neutron absorbers can be used (hafnium, boron, etc.) to allow larger dimensions to be used;

- when geometrical control is not totally applicable, additional management controls and interlock systems are enforced.

These precautions are an example of the application of the double contingency principle, by which at least two independent failures, each of low probability and reliably detectable, must occur simultaneously before there can be any significant likelihood of criticality.

In operation, criticality safety is ensured by respecting the extraction diagram, feed parameters, monitoring the internal condition of equipment, and the rigorous management of transfers. The precipitation of fissile material in an alkaline medium must be avoided by controlling the acidity.

With respect to fuels richer in fissile material, such as plutonium, further R&D would assist with simplifying the implementation of safety criticality rules by:

- design of equipment enabling the flow of material to be increased for given dimensions (e.g. extractors);
- systems for the in-line measurement of concentration (reduction in measurement tank volume);
- computer-aided instrumentation and control to reduce operating margins;
- monitoring of the process equipment to avoid the accumulation of plutonium during the extraction or washing of the fissile material.

3.2.4 Corrosion

Most incidents due to corrosion occur in process equipment in such a manner that they only cause minor or zero discharges of radioactivity. The consequences for plant operation, however, are generally far from negligible: in the Tokai mura, Dounreay and WAK plants leaks in a dissolver and in an evaporator required prolonged shutdowns in operation.

Minor faults which appeared in the acid recovery evaporators in the Tokai Reprocessing Plant, for example, required operation of the installation to be suspended during around one year each time for their replacement in 1979 and 1983. The operation lasted approximately one year on each occasion. In addition, small quantities of radioactivity were found in the condensed vapour of the first dissolver in April 1982 and in the second one in February 1983. The corroded dissolvers were repaired in place using remote controlled equipment [29]. Certain plutonium solution evaporators, such as BNFL B 205 one at Sellafield, have also been corroded by redox reactions occurring at the surface of the materials. The welded seams present just above the surface of the liquid are those that tend to be corroded, and in Japan, Germany, and other countries relatively frequent replacement have been reported. There is now a tendency to adopt materials with much greater resistance to corrosion such as zirconium, tantalum, titanium or steel with 5% tantalum, 25% chrome and 20% nickel.

Equipment exposed to concentrated nitric acid at high temperatures (100-140°C) is made of stainless steel with 25% chrome, 20% nickel and 0.25% niobium. Leaks in the acid recovery evaporators of the Tokai Reprocessing Plant appeared after 6 000 and 13 000 operating hours respectively. They were ascribed respectively to the pitting of welded seams and corrosion of the base metal of two heating tubes in the reboiler [30].

Corrosion can be limited by the application of rigorous principles of quality assurance:

- components are built and composed of materials with high corrosion resistance, on the basis of a rigorous quality assurance system: pure zirconium for nitric acid dissolvers and

evaporators, special stainless steel with a very low carbon content for the fission product concentration evaporators;

- the use of evaporators operating under reduced pressures and at lower boiling temperature constitutes a very adequate method of lengthening the useful equipment lifetime and improving the overall safety of the distillation process.

In addition, permanent monitoring of the integrity of the primary containment barrier, by measuring the contamination level of air in the process cells, ensures the early detection of leaks and the taking of mitigating measures.

Research and development programmes on the corrosion of stainless steel are under way, as well as investigations of special metals such as titanium, zirconium, hafnium, tantalum, and titanium-tantalum alloys [31]. Equipment and methods of remote repair are being perfected as a precautionary measure [29,32]. Apart from the Tokai Reprocessing Plant dissolvers mentioned above, examples of their application are as yet rare.

3.2.5 Radiation exposure

An international comparative study of the exposure to external radiation of operating personnel has been carried out [33]. Despite the increase in production and burn-up rates, a clear continuous trend toward reduction in radiation exposure in plants in operation can be observed. In general, repair work and chemical analysis represent the major sources of radiation exposure. Further significant reductions in radiation exposure can be expected with the progressive introduction of more reliable components, the application of remote control techniques, and improvements in automated or in-line sampling and analysis techniques.

The primary objective of the design of new plants in La Hague was to reduce to zero the number of operating personnel exposed to doses higher than 5 mSv per year in normal operating conditions. To attain this objective, particular attention was paid to the containment of radioactive material and to the possibilities of remote maintenance [34].

This emphasis on radiation protection from the design stage onwards has led to a steady reduction in the exposure of workers over the years: from a collective dose for the whole site of La Hague of nearly 10 man.Sv/y in 1976, it dropped to 0.37 man.Sv/y in 2002. The average dose per person monitored in the La Hague site in 2002 was 0.061 mSv/y. The specific value of collective dose versus electrical energy produced by the fuel treated in the plant has been constantly decreasing over the years. Its evolution is shown in Section 12-1.

In addition, efforts are being made to reduce discharge into the sea to a level as low as reasonably achievable (ALARA), despite a strong increase in the tonnage reprocessed since 1992. An envelope estimate of the impact of the La Hague site activities on an individual of the most exposed group (reference group) was assessed to be less than 0.02 mSv/y, compared to around 2.5 mSv/y for the average exposure to natural sources of radioactivity.

3.2.6 Explosions in the different waste reprocessing units

During the solvent extraction process used in reprocessing plants, solvent may be accidentally carried along in the stream of fission products. The mechanisms likely to cause this require careful investigation. The solvent and its degradation products (so-called “red oil”), which may cause an

explosion in the evaporator, decompose rapidly, and experience acquired in the United Kingdom demonstrates that the TBP carried along with the fission products is converted into phosphoric acid within a few hours. Explosions of red oil can be prevented by eliminating the accumulation of organic material in the solutions and controlling the wall temperature in the evaporator.

The solvent dissolved in the aqueous phase is either washed away by a counter-current stream of diluent, as is the case in La Hague, or carried away by a counter-current stream of vapour, as in Sellafield. The evaporator of the latter site operates at reduced pressure to lower the boiling point of the liquid and the rate of corrosion, and to guarantee that the temperature remains well below the threshold for solvent/nitric acid reactions. The TBP solvent currently used is considerably less reactive to nitric acid than the Hexone used in the first United States plants and the Butex used in the first United Kingdom plant.

When formaldehyde is added to destroy the nitric acid (e.g. in the French process), the parameters of the reaction must be adjusted (temperature and acidity of the solution, pressure in the evaporator, feeding rate, etc.) in order to control the reaction and ensure that it takes place smoothly. Priming of the reaction is the stage which requires the most care, and the addition of formaldehyde must be adjusted to prevent the accumulation of unreacted reagent which might lead to an explosion when the reaction starts.

Fission product evaporators are installed in heavily shielded cells (typically 1.5 to 2 meters thick high density concrete). The lower part of the cell is lined with stainless steel, forming a retaining capacity to contain any possible leak. This capacity is equipped with ejectors to transfer the liquid to other tanks. One or several additional cells, which may or may not contain another evaporating unit, can be used to act as replacement in the event of repairs to the initial evaporator. A rotating programme of renovation of the evaporators can be envisaged to maintain a continuous evaporation capacity.

The evaporator is a thick-walled stainless steel tank, generally of pot type, built on the basis of a design that has been well proven in existing plants (Figure 7.4). It is possible to imagine, given certain accident scenarios, that an explosion in an evaporator might breach the primary containment barrier, but it would almost certainly not affect the second containment barrier in the majority of existing plants. Although explosions of fission product evaporators have never occurred, United Kingdom calculations for the Sellafield plant estimate that an explosion could release about 600 litres of fission product solution into the cell in the form of finely divided mist. A large fraction of this mist would rain-out or plate-out on the cell surface. The droplets remaining in suspension in the air could be evacuated by the ventilation ducts to the HEPA filters. Moisture separators located upstream of the filters would hold back most of the mist and thus substantially limit the amount of activity discharged into the environment [35].

Figure 7.4. General view of an evaporator (Source: COGEMA – France)



3.2.7 Explosion of a plutonium evaporator

The explosion of a plutonium evaporator in a reprocessing plant might lead to a considerable discharge of plutonium (see Section 7-5.4.1). Figure 7.5 shows such an equipment. Given the risks associated with this kind of equipment, which is in addition subjected to corrosion, certain processes are organised in such a way as to avoid the necessity for concentrating plutonium solutions, thus eliminating these problems. This is the case for French facilities.

Figure 7.5. View of a plutonium evaporator at Dounreay (Source: AEA Technology – United Kingdom)

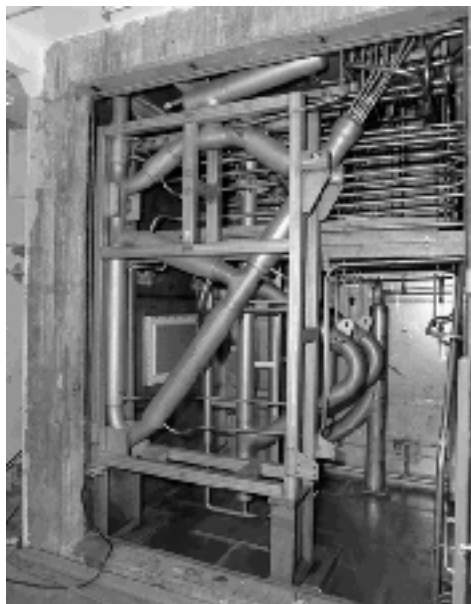

3.2.8 Ozone explosion during cryogenic krypton trapping

Given that the radiolysis of oxygen leads to the formation of ozone, it may be necessary to plan control procedures to maintain this substance at a low level of concentration. If it should be necessary to include a krypton extraction stage, the cryogenic distillation process used would bring a ozone explosion hazard.

An assessment of the ozone explosion hazard during the removal of krypton by cryogenic distillation in the DOG has been carried out [36]. The results indicate that the explosive limit is practically independent of the type of noble gas and approximately proportional to the heat capacity of the diluting gas. A reduction in the diameter of the rectification column slightly raises the explosive limit and very strongly inhibits the transition from deflagration to detonation. An increase in the pressure of the explosive mixture lowers the explosive limit.

Another process, developed in Karlsruhe, uses catalytic reduction to extract almost all the oxygen from the gases [37]. Krypton trapping techniques based on its absorption in solutions of fluorocarbon at cryogenic temperatures have also been developed [38].

3.3 Operational experience

3.3.1 La Hague plants

The good operating results achieved by the UP2-400 reprocessing plant in La Hague are principally due to:

- The attention paid to career-long training of personnel.
- The responsibility for safety assumed by the operators, under the control of the safety authorities.
- The constant application of improvements in technology, notably to mechanical operations in head end and tail end process workshops, which were responsible for the majority of shutdowns during the first years of operation of this plant.
- The experience acquired in the field of preventive maintenance and the rigorously prepared and executed maintenance work and interventions. One notable intervention took place between November 1985 and January 1986 on the high activity oxide (HAO) clarification centrifuge at the head end of the process. The beta-gamma dose rate measured on the rotor was 140 Gy/h, the actual collective dose for the 70 people involved was only 23 man.mSv [39].

The plant has operated at its rated capacity of 400 tHM/y. The end products (uranyl nitrate and plutonium dioxide) were recovered with a high yield, while meeting commercial specification requirements.

Good results in terms of productivity and availability can only be achieved by respecting rigorous safety standards. For the UP2-400 plant, no significant operating incident has been reported.

Important modifications have been made in the UP3-A and UP2-800 plants in La Hague to improve PUREX process performance, notably:

- optimised management of effluents and wastes;
- measures aimed at preventing the dispersion of alpha emitters in most liquid waste streams and directing them as much as possible into waste to be vitrified;

- improvements in decontamination efficiency (neptunium, technetium, etc.), and reductions in the salt content in liquid and solid waste;
- recycling recovered reagents as completely as possible: nitric acid, water, TBP, and diluent.

The process equipment has been designed to improve safety and reliability by:

- use of new materials such as zirconium to avoid problems of corrosion by hot nitric acid (in the dissolvers, and in the acid recovery evaporators);
- annular and cylindrical pulsed columns of safe geometry with improved packing [40], see Figure 7.6;
- choice of a continuous process rather than batch process, for example, a geometrically safe continuous dissolver of larger capacity, and equipment of large capacity for the continuous conversion of plutonium oxalate.

Figure 7.6. Pulsed column in the T2 facility at La Hague (Source: COGEMA – France)



Some more improvements were brought in the late 90s by selectively collecting liquid waste streams and sending them to newly installed evaporators. Distillates are recycled as much as possible and concentrates are sent to vitrification. This has allowed:

- to reduce the activity and flow of liquid waste discharged to the sea;
- to cease the production of bituminised waste;
- to consequently reduce substantially the volume of solid waste produced, since 5 000 bitumen drums of 0.25 m³ capacity each are replaced by 1 glass canister of 0.15 m³ (these in round figures).

The last modification at the beginning of 2000 was the commissioning of the compaction unit of ACC, which allowed further reduction in the volume of solid waste produced.

Finally, UP2-800 plant has been completed by the commissioning in 2001 of a new plutonium end facility, R4, briefly described in Section 7-5.4.2.

All these improvements have led to the achievement of levels of performance much higher than the expected design values in the fields of instantaneous or average capacity, product quality, solid waste volume and losses in waste and effluents, while at the same time substantially reducing exposure of personnel compared to former plants [41].

3.3.2 THORP plant

Improvements have also been made to the THORP plant [42] notably:

- Adoption of a reagent without salt for plutonium/uranium separation (compared with the ferrous sulphamate-based reducing agent) in order to produce salt-free medium level effluents which can then be evaporated.
- Shearing of the entire oxide fuel element compared with the decladding of the metal fuel.
- Incorporation of a centrifuge to remove insoluble fission products from the HA dissolution liquors.
- Co-extraction, separation, and purification of uranium and plutonium carried out in pulsed columns with perforated (sieve) plates instead of mixer-settlers used in Magnox plants. This change enables the plant design to prevent criticality and to achieve a reduction in liquid volumes, residence times, and degradation of organic solvents by radiation, thereby reducing the potential for losing plutonium in some effluents.
- Conversion of plutonium nitrate into PuO₂ using the oxalate route of precipitation, filtration and calcination in continuous operated equipment (rather than batch).

3.3.3 Tokai Reprocessing Plant

The Tokai Reprocessing Plant is a typical pilot plant which has achieved good operating performances. The principal characteristic is the low level of radioactive discharge into the sea.

3.3.4 Rokkasho Reprocessing Plant

Construction of the Rokkasho Reprocessing Plant in Japan started in 1993 and its commercial operation is scheduled to start in 2006; its reprocessing capacity will be 800 tHM/y. It has been designed taking into account the operating experience of the UP3-A plant in La Hague.

The following policies were adopted for the design of the plant:

- As far as possible, the best available technologies already validated in existing plants have been adopted with the aim of obtaining a high level of availability of the plant. The validity of the new technologies used will be demonstrated by mock-up tests or similar.
- A survey of experience from existing plants has been carried out and the necessary corrections and/or improvements have been integrated into the design.
- the inspection, maintenance and even the replacement of equipment located in the high-level areas has been taken into account as far as possible at the design stage, based on the information gathered from operational experience.
- The design of the solid waste processing system takes into account the characteristics suitable for final disposal.
- Discharge of radioactivity in effluents is minimised on the basis of the ALARA principle. The effective dose equivalent to the general public due to the discharge of all radioactive material into the environment is evaluated to be 22 $\mu\text{Sv/y}$ at most.
- NO_x evolved from the denitrator of uranyl nitrate solution is recovered and recycled as reagent for decomposer of residual hydrazine, oxidiser of Pu(III). Thus, the formation of low-level radioactive and non-radioactive sodium nitrate waste will be greatly diminished.
- Plutonium nitrate and uranium nitrate solutions from their purification cycles are mixed in equal metal amount and denitrated by use of microwave heating finally producing a mixed oxide (50% U and 50% Pu), which is effective for nuclear non-proliferation.
- About 10 km south of the site is a field where Japan Air Self-Defence Force and US Air Force fighters carry out gunnery and bombing practice using mock bombs. Although an aircraft crash accident onto the plant seems extremely unlikely, the facility is protected by 1.2 m thick outermost walls and roofs.
- As regards safety, the design places the greatest emphasis on the containment of radioactive material according to the Regulatory Guides for Licensing of Reprocessing Plants published in 1986 by Nuclear Safety Commission of Japan. Great attention is also paid to the prevention of fires, explosions, criticality, leaks and boiling of HLLW.
- The Regulatory Guides require for a reprocessing plant a seismic design level as high as for a nuclear power plant. The plant foundations rest directly on a competent sedimentary rock.

4. Mixed oxide fuel (MOX)

4.1 Current situation

Small quantities of MOX fuel (about 3 tHM) have been reprocessed in the pilot plants of Karlsruhe (WAK) and Marcoule (APM) [43,44].

The campaign of reprocessing of MOX fuel assemblies carried out in the Marcoule Pilot Workshop (APM) succeeded, in particular, in demonstrating the feasibility, within envelope conditions (non-diluted MOX fuel), of Pu/U separation in pulsed columns, which is the operating method envisioned for the UP2-800 plant.

Two industrial-scale campaigns of MOX fuel assembly reprocessing were later carried out in the UP2-400 plant. One campaign carried out in 1992 concerned 4.7 tHM. This campaign was carried out by mixing the solutions obtained from the MOX fuel assemblies with uranium solutions recycled from reprocessing [45,46]. Another campaign carried out in 1998 concerned 4.9 tHM. This campaign was carried out by mixing the solutions obtained from the MOX fuel assemblies with solutions

resulting from UOX fuel assemblies. These campaigns validated the combined reprocessing of UOX and MOX fuel assemblies.

Table 7.2 shows the medium-term evolution forecast for LWR spent fuel in France. MOX fuel is one of the reference fuels for the UP2-800 plant. This plant will be able to operate following different methods:

- the MOX fuel can be reprocessed mixed with standard LWR fuel, with the two fuels being sheared and dissolved alternately on the same line;
- the MOX fuel can be reprocessed using two parallel lines, one for processing the MOX fuel and the second for processing standard LWR fuel, the dissolution solutions then being mixed before the solvent extraction stage [47];
- the MOX fuel can be treated on its own, with possible dilution using uranium recycled from reprocessing.

Table 7.2. Forecast of medium-term evolutions in fuel (France)

	Uranium-based fuel	MOX fuel
Enrichment	5% U 235	12.5% Pu total
Burn-up	75 000 MWd/tHM	65 000 MWd/tHM

4.2 Safety analysis

Compared with standard LWR fuel, the UO₂ fuel with higher burn-up and the MOX fuel require modifications in the evaluation of safety:

- Increase in the plutonium flows and re-evaluation of the criticality potential.
- Higher neutron emission from spent fuel. Second-generation MOX fuel emits 35 times more neutrons than standard LWR fuel. It will therefore be diluted with standard spent fuel from LWR, but additional neutron shielding may be required.
- Multiplication of alpha emissions by a factor of 15 for second-generation MOX fuel as compared with standard LWR fuel, which will reduce the effectiveness of the cooling time before reprocessing.
- Increase in the ²³⁸Pu content: 1.66% for standard LWR fuel; 2.77% for UO₂ fuel with high burn-up; 4.27% for first-generation MOX fuel with burn-up of 65 000 MWd/tHM produced from DU. Considerably greater radiolysis will result during all stages of the solvent extraction process, above all in the final plutonium purification cycle and in the precipitation of plutonium oxalate.
- More difficult complete dissolution of spent MOX fuel may require more aggressive conditions and result in further corrosion and criticality considerations; this could be mitigated by the use of carefully controlled methods for the production of the MOX fuel.
- The need to take into account, in the production of waste, the increase in alpha radioactivity and the associated increase in thermal power. This is obtained notably by modifications in the cooling time before reprocessing.

5. Fast breeder reactor (FBR) fuel

5.1 Current situation

The development of FBRs has slowed down considerably in the end of 90s. This type has been abandoned in the United States, Germany, Italy, and more recently in the United Kingdom and France. Only Russia and Japan continue development, while the French Phénix reactor is to be put back into service for a limited time as a research reactor. A certain quantity of spent fuel nevertheless remains throughout the world, and some of this will probably be processed to extract the plutonium it contains. The subject may be of less interest here than for LWR, but it is still a current issue.

The Dounreay pilot reprocessing plant was closed down in 1996.

The Tokai mura pilot plant CPF reprocesses fuel from the Japanese experimental FBR. Japan has a national programme implemented in the Recycling Equipment Test Facility (RETF) for the development of a new generation of equipment for FBR fuel reprocessing.

Around 100 tHM of FBR fuel have been reprocessed in pilot plants after varying cooling times (minimum 136 days). A campaign of FBR fuel reprocessing has been carried out in the UP2-400 plant (around 10 tHM). The dissolution solution was mixed with the dissolution solution from gas-cooled reactor (GCR) fuel before being fed through to the extraction process. Quantities of reprocessed FBR fuel in different facilities are summarised in Appendix 1.

5.2 Safety analysis

The main differences between the reprocessing of FBR fuel and thermal reactor fuel originate in the physical structure of FBR fuel elements. The pins of such elements are enclosed in a stainless steel casing and the problem is the disassembly to gain access to the fuel pins, given the high thermal output involved. The solution adopted consists of opening the casing (by laser cutting, for example), extracting each pin, and then cutting them up, either one by one or in bundles, and loading them into the dissolver basket. Chemical separation operations are limited by the high plutonium content of the fuel. It is therefore necessary to design geometrically limited plants to control criticality, which in turn limits the throughput of the installation.

5.3 Operational experience

The reprocessing of FBR fuel requires installations designed and built to cope with the high calorific potential of the fuel, especially after a limited cooling time, the very high plutonium content, and the possible presence of sodium on the surface and inside the fuel pins. Up to now, the chop operation has been performed on single pins (or in small bundles) to avoid any overheating of equipment. The presence of residual sodium may necessitate inerting the inside of the shearing machine to prevent sparking and incidental explosions of hydrogen after contact with aqueous solutions or moist atmospheres.

The possibility of reprocessing fuel with an initial enrichment up to 12.5% in plutonium in the UP3-A and UP2-800 plants has been studied. These fuels would be cooled for 6 years before reprocessing in dilution with standard LWR fuel. As with the FBR fuel reprocessed in the UP2-400 plant, it would be advisable to disassemble the fuel elements in order to feed the shear with bundles of pins in containers.

5.4 Storage of plutonium and conversion into oxide

5.4.1 Concentration and storage of the solution

One of the end products of the separation process in the United Kingdom and Japan is a plutonium nitrate solution with a concentration of a few grams per litre. This solution cannot be stored economically, nor can it be transferred to any of the following stages of oxide or metal production. It is therefore concentrated by evaporation to obtain concentrations of approximately 300 g/l. The plutonium nitrate is then stored in buffer tanks (see Figure 7.7) before being transferred to the oxide production facility. In France, the concentration of the end solution to about 40 g/l enables it to be converted directly into PuO₂ for storage or transport, without intermediate tank storage. This is the case not only for the existing UP2 and UP3-A installations but also for the R4 workshop of the UP2-800 plant, which started up in 2001 [48].

Figure 7.7. Subcritical harp-shaped tanks for the storage of plutonium nitrate
(Source: AEA Technology – United Kingdom)

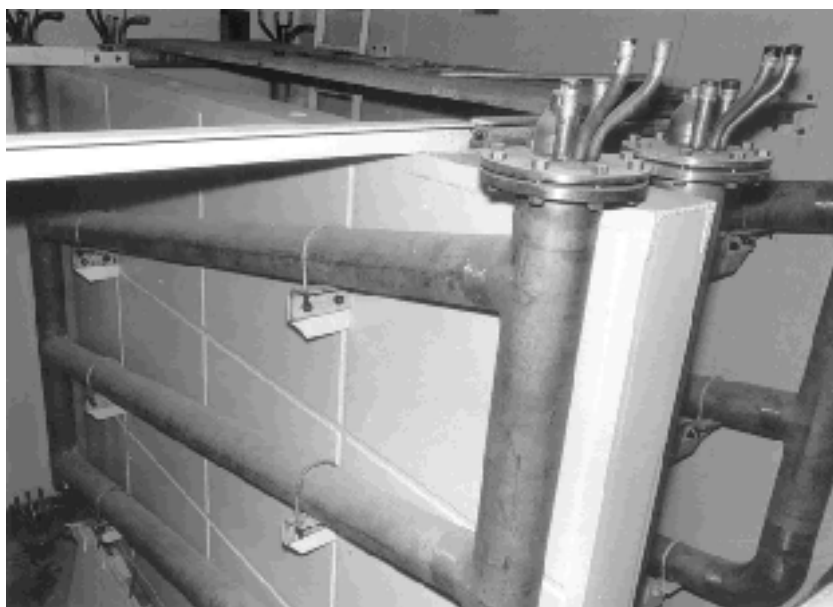

The explosion of a plutonium evaporator in a reprocessing plant may constitute one of the most serious accident scenarios (depending on the design of the plant), giving rise to a discharge of plutonium into a cell, into the zone around the glove boxes, or even into the environment in the case of serious accident. Solvent can be accidentally carried along in waste or aqueous products streams. If the solvent and its degradation products are heated in an evaporator, in contact with nitric acid and heavy metal compounds, they will decompose. In certain conditions it is possible that this decomposition may turn into thermal runaway, over-pressure, and even explosion. Although only a low probability, the runaway or explosion can be prevented by:

- Limiting as far as possible, through washing, the accumulation of organic material in the plutonium stream fed into the evaporator.
- Controlling the process parameters in the evaporator. Wall temperature is the determining factor, and it is generally maintained under 135°C [19], both for safety reasons and to reduce the corrosion rate.

When hydrazine is used in the process, there is a very slight possibility that hydrazoic acid will form in the evaporator, with a potential for an explosion. A hydrazine destruction stage may be used prior to concentration, generally by injecting nitrogen dioxide gas. This potential explosion scenario has been studied and deemed to be unrealistic [1].

Evaporator explosions might breach the primary containment barrier but it is unlikely that they would affect the second containment barrier. The aerosol produced in the cells would either plate out or be transported in the ventilation ducts to be removed by the HEPA filters. Shock waves from the explosion might generate overpressure and thus damage the filters. However, if the filters are located at a distance from the cell, most of the energy will probably have been dissipated in the ducts before reaching them. Cells are lined with stainless steel designed to prevent any leak or dispersion. Leaks from tanks and evaporators can be avoided by choosing the appropriate design and materials and by applying strict quality assurance criteria.

The production of hydrogen, and sometimes oxygen, by radiolysis can occur relatively rapidly in concentrated solutions of plutonium nitrate. Explosive hydrogen/air mixtures could build up, and it is necessary to limit the hydrogen content in the plenum of storage tanks to below the lower flammable limit of 4% by means of air venting.

The potential for a criticality excursion must be taken into consideration in the plutonium nitrate evaporation and storage workshops. Prevention is usually by geometrical control (see Section 7-3.2.3); tanks for plutonium nitrate solution are generally either thin slab tanks or harp-type tanks composed of rows of geometrically safe piping with a spacing wide enough so that interaction between two consecutive slabs or tubes be negligible. Annular tanks are also widely used. In the R4 workshop of the UP2-800 plant, subcritical tanks are usual vertical cylinder tanks, filled by an array of vertical tubes open to the outside of the tank at their both ends. Dimensions and pitch of the tubes is determined for sub-criticality, and circulation of air inside the tubes by natural convection ensures a passive cooling of the tanks.

Plutonium (VI) may form in the presence of concentrated nitric acid. This is a particularly powerful oxidising agent that can accelerate corrosion of the primary containment. Corrosion conditions in the plutonium evaporators are therefore severe, and numerous studies have been devoted to research into suitable materials to reduce the risk of leaks [7,8,49]. Zirconium, titanium, and a certain number of stainless steels meet these criteria. In France, zirconium is usually chosen for the most exposed equipment in new plants, not only for its general corrosion resistance but also for its resistance to intergranular corrosion [50,51]. In the United Kingdom, titanium has been used in the past for plutonium evaporators, but the THORP plant uses zirconium.

Pu (VI) can also lead to the generation of hydrogen. Combined with the potential for corrosion, this requires that plutonium be converted as much as possible to Pu (IV) before storage.

In the United Kingdom the plutonium nitrate solution used to be transported by ship, in casks, from Dounreay to Sellafield where it was converted into oxide. Needless to say, none of the above-mentioned hazards must be neglected during such transports of fissile material.

5.4.2 Conversion of plutonium and solid form storage.

The purified plutonium nitrate solution is transferred into a buffer tank before being fed into the conversion line in which it is transformed into PuO₂ powder. This is the usual intermediate form that

allows storage and transportation before the use in MOX fuel (the Japanese co-conversion process also uses an oxide powder, but of mixed uranium and plutonium).

In general, plutonium in the nitrate solution is precipitated by oxalic acid at a temperature of around 60°C. The plutonium oxalate precipitate is filtered and washed; the supernatant is recycled into the process. The precipitate is then transferred into a calcination furnace where it is first dehydrated at a temperature of around 250°C before being converted into PuO₂ at an average temperature of 450°C.

The PuO₂ powder is transferred from the furnace into a mixing hopper. When homogenised, the powder is loaded into stainless steel cans directly connected onto the mixing hopper. The cans are then disconnected from the hopper, closed with lids, and loaded into a transfer case made of stainless steel. The lid of this case is then welded shut. All these operations are carried out in glove boxes. The transfer case is detached from the glove box without any breach in containment so that its outside is never in contact with areas where powder can be present. It is then placed in a stainless steel container transferred to the storage building where the containers are stored in vaults and cooled by air circulation.

The containment of very fine PuO₂ powder is one of the main operating problems encountered. The development of a stainless steel transfer case to replace the plastic sleeves previously used for the transfer of the cans of PuO₂ represents a marked improvement. The process is operated at a distance, from the control room. The personnel coming on the premises (for surveillance or maintenance) is generally protected by two containment barriers: process equipment and glove box in the conversion unit; container and storage structure in the storage building.

Criticality must be considered with the greatest care; all the process equipment used in the conversion and storage units are therefore assessed and designed to be geometrically safe.

It must be demonstrated that the containers of PuO₂ are designed to withstand, for the whole duration of storage, the maximum pressure rise which may be exerted under the effects of radiolysis and heat (several hPa or bars).

All the materials in the conversion workshop process and the structures or containers in the storage building must also be designed to withstand the maximum rise in temperature which may be generated by the heat of plutonium decay in the event of prolonged loss of the cooling system. The conversion unit and storage building must also be designed and built to remain subcritical in the event of flooding, fire, or earthquake.

A new plutonium purification, conversion, and conditioning unit, called R4, came into service in 2001 in UP2-800 plant at La Hague to replace the oldest units in the plant. Purification is carried out in subcritical centrifugal extractors with very short contact time, through one cycle only which enables commercial specifications to be respected. The unit is remote controlled, using numerous in-line analyses. It includes subcritical buffer tanks of an original design, with passive cooling as described above, and optimised layout of equipment and cells to reduce the volume and, consequently, the cost of the unit [52]. The plutonium oxide storage building features indirect cooling that is a safety improvement relative to the former facilities.

5.5 Storage of uranium and oxide conversion

The principal final product of the separation process is uranyl nitrate solution with a concentration of several tens of grams per litre. The volumes of uranyl nitrate produced by industrial

reprocessing are such that their storage in liquid form represents a far-from-economic solution. The liquid is therefore concentrated by evaporation, to concentrations of 400 to 500 g/l, and then transferred to buffer tanks before being converted into uranium oxide powder by means of a thermal conversion process.

If ^{235}U enrichment of uranyl nitrate solutions is controlled at a level below about 2%, criticality safety can be ensured without further restriction. This is generally the case with fuel which has been sufficiently irradiated, if not by blending it with DU. Calculations can be used to confirm the precise limiting value for a given set of plant and process parameters. If ^{235}U enrichment is greater than about 2%, control of the concentration is generally used for the uranyl nitrate solutions; geometrical control is used in the oxide conversion process and for oxide storage facilities (occasionally in combination with moderation control).

The handling of recycled uranium poses other safety problems, notably that of radiation dose rates. This point is investigated in detail in Section 5-3.4.2.

The red oil hazard, referred to in Section 7-3.2.6, also needs to be considered for the uranyl nitrate evaporator. The problem of radiolysis is much less severe. Corrosion conditions in uranium evaporators are generally less aggressive than those in plutonium evaporators, and stainless steel may be used for their construction.

Uranium oxide can be produced by thermal direct denitration (TDN) of the uranyl nitrate or by precipitation in the form of ADU followed by calcination. In the TDN process, uranyl nitrate solution is sprayed in a reactor with a fluidised bed of UO_3 powder (See Section 2-2.4 for details of the processes). The construction material for the vessel must be chosen with great care if erosion is to be avoided.

The TDN and ADU processes produce uranium oxide powder with a very fine grain structure, the handling of which requires special ventilation systems to prevent inhalation or ingestion by the personnel.

Uranium oxide is stored in mild steel drums and generally presents no hazard. Radiation levels are very low for low burn-up material; but the presence of ^{232}U (see Section 5-3.4.2) in products originating from high burn-up fuel gives rise to high levels of gamma radiation, increasing with time to reach equilibrium after about 10 years. The storage installations for such material must take this particularity into account and therefore be designed on the basis of stricter standards than installations designed for the storage of current production.

6. References

- [1] Schmieder, H. and Ebert, K. (1989), "Safety of Reprocessing Under the Research and Development Aspect", *Safety of the Nuclear Fuel Cycle*, edited by K. Ebert and R. von Ammon.
- [2] Desvaux, J.L. *et al.* (1998), *COGEMA Reprocessing Complex: Already 9 Years of Operation, Mature and Flexible*, RECOD-98, Nice, Vol. 1, pp. 27-33.
- [3] Nuclear Power Technology (1993), *Fuel Cycle*, edited by W. Marshall, Vol. 2, Clarendon Press.

- [4] Pozzi, F. *et al.* (1987), *Technical and Commercial Aspects of European MTR Reprocessing*, RECOD-87, Paris, pp. 211-223.
- [5] Weinlander, W. *et al.* (1991), *Twenty Years of WAK Reprocessing Pilot Plant Operation*, RECOD-91, Vol. 1, pp. 55-63.
- [6] Simonnet, J. *et al.* (1987), *Development and Use of Zirconium in Reprocessing Commitment, International Conference on Nuclear Fuel Reprocessing and Waste Management*, RECOD-87, Paris, pp. 1215-1218.
- [7] Okubo, M. *et al.* (1987), *Demonstration Tests on Corrosion Resistance of Equipment for Spent Fuel Reprocessing Process*, RECOD-87, Paris, pp. 1181-1188.
- [8] Marx, G. *et al.* (1987), *Investigation on the Corrosion of Valve Metals and Alloys Under the Influence of Plutonium*, RECOD-87, Paris, pp. 1208-1209.
- [9] Kiuchi, K. (1998), *The Life Prediction Study of Rokkasho Reprocessing Plant Materials*, RECOD-98, Nice, Vol. 3, pp. 859-866.
- [10] Fauvet *et al.* (1994), *Corrosion Behaviour of Stainless Steels and Zirconium in Nitric Media Containing Iodine*, RECOD-94, Londres, 1) Session Corrosion and Materials Selection.
- [11] Ford, L.H. *et al.* (1987), *The UK Achievements in the Application of Power Fluidic Technology for Nuclear Processing Plants*, RECOD-87, Paris, pp. 1539-1542.
- [12] Schmieder, H. *et al.* (1987), *Results and Objectives of Research and Development Work for Nuclear Reprocessing*, RECOD-87, Paris, pp. 393-402.
- [13] Costanzo, D. and Biggers, R. (1963), *Study of the Polymerization, Depolymerization and Precipitation of Tetravalent Plutonium as Functions of Temperature and Acidity*, ORNL-TW-585, Oak Ridge National Laboratory.
- [14] Dhanpat, R. and Serne, R.J. (1978), *Solution Species of Plutonium-239 in Oxidizing Environments: Polymeric Pu (IV)*, PNL-SA/6994.
- [15] Proceedings of the CSNI Specialist Meeting on Interaction of Fire and Explosions with Ventilation Systems in Nuclear Facilities (1993), Los Alamos.
- [16] IAEA (1989), Symposium on Fire Protection and Fire Fighting in Nuclear Installations, Session 6, Vienna.
- [17] Malet, J.C. *et al.* (1983), *Solvent Pool Fire Testing Interaction of Fire and Explosion with Ventilation System in Nuclear Facilities*, Proceedings CSNI Specialists Meeting, Los Alamos, LA-9911.C, Los Alamos National Laboratory, Los Alamos, NM, pp. 391-404.
- [18] Lillyman, E. (1983), *Interaction of Fire and Explosion with Ventilation Systems of Fuel Cycle Plants*, Proceedings CSNI Specialists Meeting, Los Alamos, LA-9911.C, Los Alamos National Laboratory, Los Alamos, NM, pp. 467-477.

- [19] Lefort, G. (1983), *Potential Fire or Explosion Risks in Reprocessing Plants*, Proceedings CSNI Specialists Meeting, Los Alamos, LA-9911.C, Los Alamos National Laboratory, Los Alamos, NM, pp. 41-55.
- [20] HSE (1986), *Safety Audit*, Health and Safety Executive, Sellafield, UK.
- [21] Thiollay, N. *et al.* (1999), *Taking Burn-Up Credit into Account in Criticality Studies – The Situation as it Is Now and the Prospects for the Future*, Congrès International de Criticité, Versailles.
- [22] Aoyagi, H. (1998), *Basic Concepts of Criticality Safety in Rokkasho Reprocessing Plant*, RECOD-98, Nice, Vol. 1, pp. 37-44.
- [23] Wurtz, W., Bereznai, T., Kroebel, T., Andriessen, H. and Munzel, H. (1987), *Pyrophoric Properties of Radioactive Zircaloy Fines*, RECOD-87, Vol. 2, p. 545.
- [24] Andriessen, H. *et al.* (1987), *Untersuchungen zum Brand und Explosionsverhalten von Zircaloy Feinteilen (Experiments on Fire and Explosive Properties of Zircaloy Fines)*, EUR 11120, Commission of the European Communities, Brussels.
- [25] James, N.J. *et al.* (1985), *Zircaloy Hazards in Nuclear Fuel Reprocessing*, Symposium Series No. 97, Institution of Chemical Engineers (IChemE).
- [26] Malet, J.C. *et al.* (1983), *Solvent Pool Fire Testing Interaction of Fire and Explosion with Ventilation System in Nuclear Facilities*, Proceedings CSNI Specialists Meeting, Los Alamos, LA-9911.C, Los Alamos National Laboratory, Los Alamos, NM, pp. 391-404. *Calculating the Consequences of a Kerosene Poolfire with the FLAMME Computer Code*, *ibid.*, pp. 169-182.
- [27] Dukes, E.E. and Wallace, R.M. (1962), *USAEC Report*, DP-728.
- [28] Ertel, D., Schmieder, H. and Stollenwerk, A.H. (1988), “The Behavior of Hydrazoic Acid in PUREX Process Solutions Under Safety Aspects”, *Safety of the Fuel Cycle, VCM*, edited by K. Ebert and R. von Ammon, p. 107.
- [29] Naito, S. *et al.* (1991b), *Remote Inspection of Repaired Dissolvers and Improvements of Remote Maintenance Robots*, RECOD-91, pp. 157-162.
- [30] Yamanouchi, T., Omachi, S. and Matsumoto, K., (1987), *Decadal Operational Experience of the Tokai Reprocessing Plant*, RECOD-87, Vol. 1, p. 195-202.
- [31] Elfenthal, L. and Schultze, J.W.Q. (1989), *Passivity of Ti and Ta Oxide Film*, p. 137, and G. Marx *et al.*, “Corrosion of Valve Metals Under the Influences of Various Components Including Plutonium”, p. 159, *Safety of the Nuclear Fuel Cycle*, edited by K. Ebert and R. von Ammon.
- [32] Miyahara, K. *et al.* (1991), *Operational Experience at Tokai Reprocessing Plant*, RECOD-91, Sendai, Japan, Vol. 1, pp. 49-54.
- [33] NEA (2000), *Radiological Impacts of Spent Nuclear Fuel Management Options – A Comparative Study*, OECD, Paris.

- [34] Chenevier, F., Bernard, C. and Giraud, J.P. (1987), *Design and Construction of the New Reprocessing Plant at La Hague*, RECOD-87, Vol. 1, p. 97.
- [35] Warner, B.F. (1978), "The Thermal Oxide Reprocessing Plant (THORP)", *HMSO Report, General Description and Objectives*, Testimony presented at the Windscale Inquiry, UK.
- [36] Weh, M., Penzhorn, R.D., Gunther, K. and Ache, H.J. (1986), "Safety Considerations Concerning the Cryogenic Distillation of Fission Noble Gases", *Gaseous Effluent Treatment in Nuclear Installations*, Proceedings Conference Luxembourg, 1985, G. Fraser and F. Luykz, EUR 10580, edited by Graham et Trotman, London, p. 359.
- [37] Von Ammon, R. *et al.* (1980), Proceedings of the 16th DOE Nuclear Air Cleaning Conference, San Diego.
- [38] Henrich, E., Weirich, F. and Bander, U. (1987), "Engineering Scale Development of Tail End Purification Steps for the Dissolver Off-Gas in Reprocessing Plants", *Nuclear Fuel Reprocessing and Waste Management*, Proceedings of the International Conference, Paris, Vol. 2, pp. 553-562, RECOD-87, Société Française d'Énergie Nucléaire.
- [39] Delange, M. (1987), *LWR Spent Fuel Reprocessing at La Hague: Ten Years On*, RECOD-87, Vol. 1, p. 187.
- [40] Coste, J.A., Mathieu, D. and Bernier, G. (1987), *Colonnes Pulsées Annulaires, Résultats d'Essais*, RECOD-87, Vol. IV, pp. 1529-1535.
- [41] Dabat, R. *et al.* (1994), *UP3-A Compliance with the Final Safety Analysis Report After Four Years of Operating Experience*, RECOD-94, Londres 3, Session 7B.
- [42] Fryer, A.C. *et al.* (1994), *The Plant Safety Case for the Thermal Oxide Reprocessing Plant at Sellafield*, RECOD-94, Londres, 2, Session 7B.
- [43] Willax, H.O. and Weishaupt, M. (1987), *Reprocessing Plant Karlsruhe (WAK) Plant Experience and Future Tasks*, RECOD-87, Vol. 1, pp. 203-210.
- [44] Calame-Longjean, A. *et al.* (1987), *Rénovation et Extensions pour la Recherche et le Développement à l'Atelier Pilote de Marcoule*, RECOD-87, Vol. 1, p. 115.
- [45] Gillet, B. *et al.* (1994), *French Experience in MOX Fuel Reprocessing*, RECOD-94, Londres, Vol. 4, Session 4A.
- [46] Gay, A. (1998), *MOX Fuels Recycling*, RECOD-98.
- [47] Ayçoberry, C. (1987), *Reprocessing in France, Situation and Prospect*, RECOD-87, Vol. 1, p. 13.
- [48] Brossard, M.P. *et al.* (2000), *Continuous Plutonium Conversion: French Engineering and Plant Operating Experience*, AIChE 2000 Spring Meeting, Atlanta.
- [49] Takeda, S. *et al.* (1991), *Corrosion Resistance of Several Metals in Plutonium Nitrate Solution*, RECOD-91, Vol. 2, pp. 555-557.

- [50] RS-AGK 5-510321/2 (1983), *Der Bundesminister des Innern: Sicherheitsanforderungen für Kernbrennstoffversorgungsanlagen*, Teile II, III, Juni 1983.
- [51] Bernard, C. *et al.* (1991), *Zirconium-Made Equipment for the New La Hague Reprocessing Plants*, RECOD-91, Vol. 2, pp. 570-576.
- [52] Bertolotti, G., De Laguerie, I.V., Richter, R. Gillet, B. (1998), *R4 Innovative Concept for Plutonium Finishing Facility*, RECOD-98, Vol. 1, pp. 11-18.

Chapter 8

SAFETY OF THE MANAGEMENT OF RADIOACTIVE WASTE

1. General considerations

The management of radioactive waste requires the adoption of a certain number of policies and practices that share a common objective: the handling, interim storage, and disposal of radioactive waste with every necessary safety precaution to prevent any undue radiation of people or contamination of the environment over both the short and the long term.

This leads to preclude as much as possible the use of bulk interim storages (trenches, silos, etc.) by conditioning by-products under a safe form immediately in-line with the process.

Each category of radioactive waste must be directed toward an elimination route adapted to its particular characteristics.

In France, short-lived low- and medium-level waste benefits from the existence of a fully defined route which results in definitive disposal in a ground-level storage facility. High-level long-lived waste represents a very low volume, but concentrates a high level of toxicity for a long time. Several methods have been explored for the management of this waste: the partition and transmutation of the most toxic radioactive nuclides, disposal in deep geologic repositories, long term interim storage, and associated conditioning.

The question of disposal is a wide full subject. Numerous reports deal with it, notably at the international level [1,2] and the safety of waste disposal does not, consequently, come within the scope of the present report. It is important, however, to take into consideration the accident potential inherent in handling, processing and storage operations of radioactive waste before final disposal, as for any other operation involving radioactivity within the fuel cycle. This Section will, therefore, review the various waste management practices in use, in an order which reflects their relative importance, as it broadly corresponds to the decreasing level of radioactive content.

Only the principal reprocessing waste will be examined here, as opposed to the technological waste resulting from operation, e.g. gloves, clothing, tools, used parts of the equipment that have been contaminated and must be disposed of. The level of activity of the latter is generally much lower than that of the reprocessing waste, and they are conditioned and transferred to disposal sites that may be at ground level in certain countries (France, United Kingdom, for example) or underground (Sweden, Germany, for example). Various techniques may be used to minimise the volume of the waste conditioned, such as the incineration, melting [3] or compaction used in France.

Some minor reprocessing waste resulting from the interim underwater storage and dissolution of spent fuel, such as the ion-exchange resins used to treat pool water, barium carbonate (containing ^{14}C), and silver zeolites (containing H_3 or I), should be mentioned for completeness. Their conditioning (for

example in polymer or concrete) and storage do not raise any particular on-site safety issues, and they are not discussed any further.

One essential point is that priority must be given in the design of reprocessing-recycling systems to the minimisation of the quantity or volume of waste produced and its level of radioactivity, and to provide safe and easily retrievable on-site interim storage of the waste held on site. Considerable research and development efforts have been devoted to the investigation of new techniques for minimising the quantities and volumes of waste [4,5,6,7,8].

COGEMA has designed a new unit called ACC (Hull Compaction Workshop) (Figure 8.1), commissioned at the beginning of 2002, to significantly reduce the volume of conditioned waste (Figure 8.2) [9]. This facility compacts structural waste (hulls, end pieces, etc.) and technological waste into disks which are then introduced into containers known as “Compacted Waste Universal Canisters” that are externally identical to vitrified waste containers. This standardisation facilitates the operations of handling, transport, interim storage and final disposal of the waste.

Figure 8.1. Compacting press in the ACC facility at La Hague (Source: COGEMA – France)



Figure 8.2. Volume of waste conditioned for disposal in UP3-A (Source: COGEMA – France)

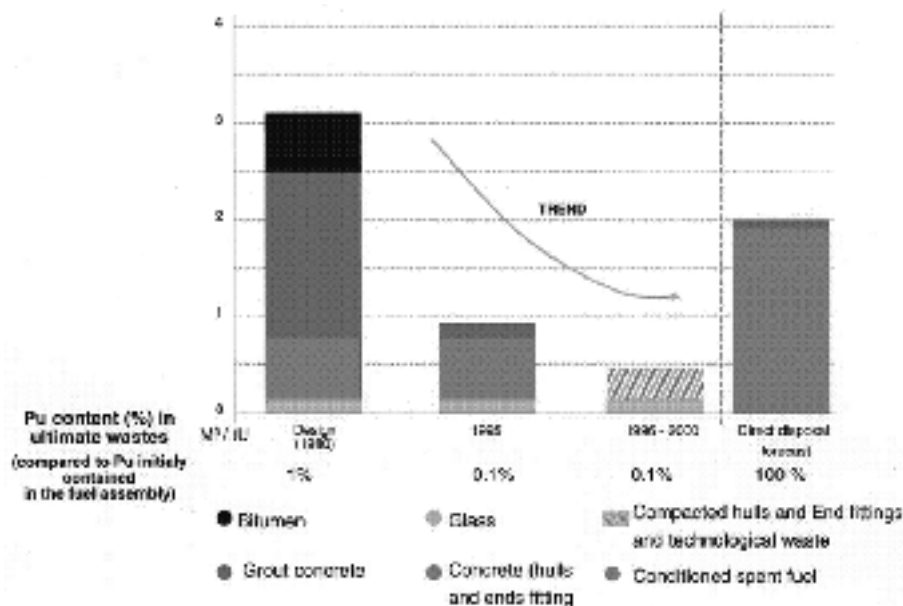

2. High-level liquid waste

HLLW results from the reprocessing of spent nuclear fuel from which the plutonium and unburnt uranium have been extracted in a chemical separation plant. It is composed of a mixture of nitrates in solution in nitric acid, containing more than 99% of the non-gaseous fission products, very low quantities of uranium and plutonium, but almost all the transuranium elements initially present in the spent fuel. It also contains activation products, corrosion products of steel, iron, nickel, and chrome, and may also contain other chemical products added during reprocessing, such as sodium, gadolinium, cadmium, boron, and fluorine. All HLLW generate heat and must be cooled.

After separation during the reprocessing process, the HLLW is concentrated by evaporation to minimise the number of interim storage tanks required. Liquid storage is an intermediate stage between reprocessing and solidification, but the time scale and duration of this liquid storage depend on numerous factors. The cooling time of spent fuel – a strict minimum of 90 days – is normally governed by the decay of several nuclides, notably ^{106}Ru and ^{131}I . In practice, LWR fuel reprocessing only takes place after several years of cooling (in France the reference cooling time of spent LWR fuel before reprocessing is currently between 3 and 5 years). This delay allows many short-lived fission products to decay and the specific activity to lower, reducing the problems they could cause during reprocessing. In addition, the eventual solidification of the liquid waste may be easier after prolonged cooling.

Theoretically, other factors may also have to be taken into account, such as the commercial interest of extracting certain fission products from the liquid waste and the possible separation of actinides. Given the difficulty that such activities represent, it is unlikely that they will be carried out on an industrial scale in the near future. They could nevertheless be developed to extract certain long-lived radioactive nuclides which could then be transmuted into nuclides with shorter half-lives or

conditioned in a specific way. In both cases, the aim would be to facilitate the safety of final geological disposal [10,11,12,13,17].

The current practice is to store HLLW in stainless steel tanks with forced cooling systems. The failure of the storage tanks, and especially the cooling system, might result in the discharge of large quantities of fission products, and this form of storage therefore requires constant monitoring. This is why solidification is regarded as a significant improvement in safety terms [15], even if the tank storage system has a high level of safety, as proven by the 50 years of use in numerous sites without accidental discharge.

Modifications in fuel design, in terms of initial enrichment and burn-up, are taken into account by adapting the cooling time before reprocessing and the concentration of waste in the solution to ensure that the technical and safety specifications of the storage units are respected, notably as regards thermal parameters.

2.1 Storage in liquid form

Reprocessing of spent fuel and storage of HLLW started about 50 years ago; long-term experience has therefore been acquired. This experience has been summarised by the IAEA in a technical report which is still today considered to be a comprehensive presentation of the knowledge acquired [16]. At present, HLLW is generally stored in the form of nitric acid solution in structures with a high level of integrity; these are single- or double-walled tanks made of stainless steel, situated in concrete cells with thick walls which provide protection against radiation and constitute an additional containment barrier. The typical level of activity for a tank of HLLW is about 10^7 TBq for 100 m^3 . The storage tanks must be equipped with a complex and reliable cooling system to extract the decay heat generated. They must also be equipped with a stirring system of agitation to prevent precipitates from settling and causing the formation of local corrosion spots, and it must be possible to transfer the contents into a standby tank in the event of leakage. For this purpose, a spare tank policy is often implemented to cope with an incident which may arise at any moment in any of the tanks in service. Off-gas treatment systems, temperature and liquid level monitoring systems, and venting systems to dilute the hydrogen produced by radiolysis and maintain its concentration well below the ignition limit are also installed. The design of a HLLW storage tank in service in Japan is given in Figure 8.3 and a photograph of a HLLW storage tank being constructed in the United Kingdom is given in Figure 8.4.

The tanks currently in service or planned have a capacity of between 50 and 150 m^3 . They are housed, either singly or in groups, in concrete cells with walls between 1.5 and 2.4 meters thick (they can be built either partially or totally below ground level). This thickness of concrete provides protection against ionising radiation and against external aggressions such as the accidental crashing of a business plane (Learjet type). The base and walls of the cell are lined in stainless steel to a height sufficient to retain the total contents of at least one tank in the highly improbable event of a leak. The slope of the cell floor leads to a sump and cell wash pipes are installed, in case of leakage from the stainless steel tank. The cooling system of the tank, the support structure, and the cell in which it is housed must be designed to withstand a possible rise in ground water level and other extreme natural events such as earthquakes. It may therefore be necessary to include drainage and a specific mode of construction, the definition of which will vary depending on the site and the type of installation.

Figure 8.3. Sectional diagram of a HLLW tank (Source: JNC – Japan)

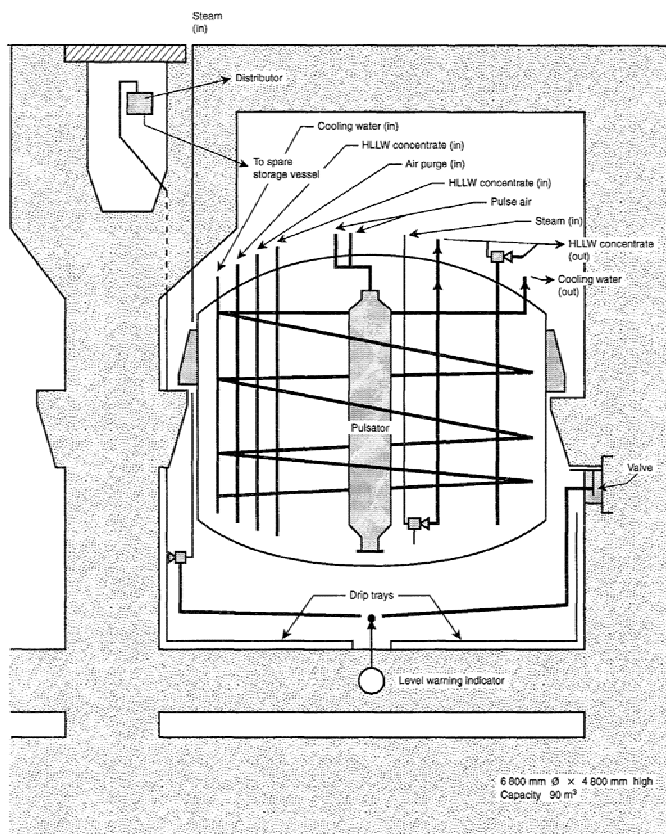

Figure 8.4. View of an HLLW tank with cooling coils (Source: BNFL – United Kingdom)



The cooling system is composed of a series of internal, independent coils arranged in a certain number of parallel circuits. Their heat extraction capacity is sufficient to cope with the maximum heat production envisaged for the liquid waste in the tank, and emergency back-up circuits are included in case of an incident in one or several circuits.

In addition to the coils inside the tank, some tanks are fitted with an outer cooling jacket which can also fulfil two other functions: acting as an additional containment barrier in case the main tank leaks and contributing to the cooling of the bottom of the tank, thus preventing accelerated corrosion in the event of solids settling (See Figure 8.5).

Figure 8.5. HLLW tank showing bottom cooling jackets (Source: Japan)



In all cases, it is important to have reliable sources of cooling water available. Cooling basins, towers and sinks, together with rivers and seas, all represent possible sources. In the case of a large lake or an ocean, one source fitted with multiple transfer lines may be sufficient. In the NFS West Valley plant in the United States, air-cooled finned heat exchangers provide emergency back-up cooling.

Most installations are equipped with closed-loop circuit water cooling between the tanks and the external source of cooling water, this latter being separated by heat exchangers. This prevents any radioactive material that might escape through a leaking coil from being transferred to the external cooling water. Provisioning a reliable, positive pressure gradient between the cooling water and the tank contents also reduces the possibility of radioactivity being transferred into the cooling water, in the unlikely event of a coil leaking.

The cooling water circuit has one or several auxiliary supplies of electric energy for the circulating pumps. The reliability of the electricity supply must be assessed and proved to be sufficient.

When a new tank begins to function after commissioning, it is usually partially filled with water or, preferably, diluted nitric acid (which prevents possible start of irreversible intergranular corrosion of stainless steel by chlorine ions often present in water), to ensure that the heat transfer surface is sufficiently covered by the liquid to extract the heat as and when the fission product solution is fed into the tank. When the normal operating level is attained, the excess liquid is extracted by evaporation inside the tank, and the volume thus liberated is filled with additional fission product solution. It is

essential to carefully control the rate of addition of the fission products solution and to monitor the temperature and heat extraction. The operation of the cooling circuit, which comprises each coil circuit and the outer jacket (if there is one), is monitored to ensure that the rated heat transfer coefficients are maintained; the first effect of sedimentation is a local reduction in the heat transfer coefficient and a subsequent local temperature rise.

Any gradient in the temperature profile, especially if it rises toward the bottom, indicates sludge sedimentation at the bottom of the tank.

In practice, the temperature of liquid waste is kept below 60-65°C. This temperature value enables the ejectors transferring the liquid toward vitrification or into an emergency tank to prime, limits the corrosion rate and, in case of loss of cooling, provides a time period before boiling (which might cause significant discharge) long enough to enable faulty material to be repaired or preventive action to be taken before the boiling point is reached.

The plenum of the tanks must be vented to dilute the hydrogen produced by radiolysis and thus maintain its concentration well below the ignition limit.

Considerable experience has been acquired in several plants throughout the world in the field of HLLW tank management. Some leaks of liquid waste into the cooling circuits have been observed and have led to the isolation of the cooling coils involved. In normal operating conditions, safety depends on usual radiation protection and containment barrier principles combined with good engineering design, optimum construction quality, constant monitoring, and control of the important parameters of temperature and liquid levels.

2.2 Safety considerations

To provide safe storage for HLLW requires reliable containment and cooling together with appropriate radiation shielding. The safety assessment of a project must include studies of the ecological, geological, seismological, hydrological, and meteorological aspects of the site, and an assessment of the local environmental impact of the site. The studies must also include data on the frequency and gravity of local natural hazards such as earthquake, flooding, and tornadoes so that these phenomena can be taken into account in the design of the installation. These data are particularly important because natural disasters, heavy impact of missiles of external origin, and other types of catastrophe are all potential sources of an accident which might lead to a loss of containment, cooling or biological protection.

The heat produced in storage is a function of the characteristics of the liquid waste. Certain plants have adopted the value of 17.5 W (15 kcal/h) per litre as the design-basis value. The current trend is to include a safety margin so that tanks designed on the basis of this value are only allowed to contain liquid waste producing about 9 W/l, which corresponds to about 100 TBq/l (2 500 Ci/l). Prolonged loss of the cooling system, although a highly improbable event, might in theory lead to a non-negligible discharge of radioactivity into the environment. HLLW storage installations can, however, withstand a loss of cooling lasting several hours, perhaps several tens of hours, or even indefinitely – depending on the design of the equipment and the cooling time of the stored solutions – without any significant potential for radioactive discharge, for the following reasons:

- relatively low heat generation rate of the liquid waste;
- low normal operating temperature;
- high thermal inertia of the system.

Containment failure is another potential source of considerable radioactive discharge through leakage. It could result from the corrosion process or accidental situations.

Although the probability of fire affecting the emergency systems is relatively low, the potential gravity of the consequences for the tank is such that considerable precautions should be taken to prevent it. Preventive measures include minimising the use of combustible materials and the provision of early detection and extinguishing systems. Fire in the electrical circuits is the most likely potential type of fire; this must not be underestimated as it might lead to the loss of control and electricity supply systems which could in turn lead to a loss of cooling. This type of incident occurred at the La Hague site without any major consequences, and is described in more detail in Section 12-3.

2.3 *Cooling system loss*

A serious accident could be caused by prolonged loss of the cooling system of the storage tanks if none of the safety systems included in the design were in operational condition. In this case, the following sequence of events could be envisioned:

- Phase 1: the internal temperature of the tank rises until the boiling point of the liquid waste is reached.
- Phase 2: the liquid waste slowly evaporates. During this phase volatile and semi-volatile fission products, mainly ruthenium, could possibly be discharged into the atmosphere through the off-gas treatment system.

A number of studies have been carried out to quantify the time scale of semi-volatile radioactive nuclide discharge, based on experimental [16] and theoretical models [17]. Tests have demonstrated that in the worst case of thermal load, it would take at least three or four days for HLLW to evaporate to dryness and become a source of semi-volatile radioactive nuclides (^{106}Ru , for example) [17].

Preventive measures, such as the redundancy of cooling systems and electricity supplies, together with constant monitoring, are indispensable for attaining a satisfactory level of safety. Actual data should be used whenever possible to calculate the parameters used in the studies. Practical remedial measures can then be proposed for the time available for each step in the sequence.

All the experts agree that in reality the probability of a cooling system loss lasting up to the completion of phase 1 seems extremely low. Research is nevertheless carried out with the aim of continuing to improve cooling systems reliability.

2.4 *Containment failure*

Apart from prolonged loss of cooling, corrosion processes are the main potential source of containment failure in HLLW storage tanks. They must, therefore, be taken into consideration at the design stage, by choosing the materials, specifications, and operating conditions likely to prevent or minimise their occurrence. [16] describes the various techniques used and measures taken to avoid the significant effects of corrosion. The main parameters are temperature, acidity, radioactivity, concentration, and homogeneity of waste solutions.

Corrosion may be accelerated by local heating, mechanical stress, addition of incompatible chemical substances, or errors in construction. This may result in unexpected leaks.

Radiolysis may destroy nitric acid and increase the pH of the solution, and this may precipitate some solutes. This can be detected by systematic sampling and analysis and counteracted by the controlled addition of nitric acid. Radiolysis very often accelerates chemical reactions, and this effect should be anticipated. Sedimentation may create hot spots and increase corrosion rates: this can be avoided by stirring. Normal venting provides adequate protection against abnormally high or low pressure.

In the storage tanks designed in France, the United Kingdom, and Japan, for example, containment failure caused by corrosion is not likely to develop into the type of extreme situation sometimes envisioned for a total and prolonged cooling system loss. A leak caused by corrosion in a stainless steel tank would most probably be relatively limited in size initially, and would subsequently only develop gradually with time. It would be detected at an early stage by the permanent monitoring for radioactivity in the cell ventilation system. If a secondary containment barrier has been installed, as is generally the case, the spread of the leak would be limited. If the leak occurred in a cooling coil, it would be detected by the continuous radioactivity monitoring system in the cooling circuit. The spread would then be limited by isolating the cooling coil involved.

A requirement is imposed that it must be possible to transfer the contents of any tank into a back-up tank in case of emergency, and that this spare tank must always be available. In the very unfavourable but extremely improbable hypothesis of failure in the secondary barriers, if they were all to present varying degrees of failure, the ion retention properties of the ground around the facility would almost certainly be such that most of the discharged radioactivity would remain confined in the immediate vicinity, thus enabling remedial measures to be taken. Though they may be important, notably in terms of operational reliability, corrosion aspects are therefore much less significant in terms of potential releases of radioactivity into the environment.

It has been assumed, up to now, that radiolysis of HLLW might generate enough hydrogen to constitute a flammable mixture. Hydrogen could accumulate in the plenum of the tanks, and systems are generally installed to dilute this hydrogen by sweeping air above the liquid surface and venting it through the off-gas system.

To investigate the possible effects of radiolysis, laboratory experiments have been carried out in Germany on actual process solutions, both for fuel dissolution liquors and for HLLW from the PUREX process (burn-up 30 000 MWd/tHM; cooling time: 420 days) [18]. The value of $G(\text{H}_2)$ (number of molecules of H_2 produced per 100 eV of energy absorbed) was at about 1.5×10^{-3} compared with a value of $G(\text{H}_2)$ of 0.44 measured for pure water. Research carried out in the WAK installation in Karlsruhe [19] showed that the production of hydrogen by radiolysis in HLLW is on the order of 1.5×10^{-6} molecules of $\text{H}_2/100$ eV. This value is 1 000 times lower than that experimentally determined in the laboratory and 300 000 times lower than the value of 0.44 which is generally taken into account in safety analysis. Substantial margins are then in place for this issue.

HLLW was transferred from an old storage installation (WAK) in the Karlsruhe site to a new installation (LAVA) in 1987 [20]. In addition to the conventional monitoring and control equipment, the tanks in the LAVA installation are fitted with thirteen thermocouples attached to the outside of each tank to detect any settling of high-level solids on the tank walls. Each tank has a cooling capacity of 250 kW. The installation is equipped with an emergency system composed of two diesel generators, other redundant electrical system, and a deep well. About 63 m^3 of HLLW, which had been stored for 16 years, were transferred in batches of 1.5 m^3 by steam ejector. The quantity of precipitates was found to be very small (~0.92% by weight) and the fissile plutonium content was only about 2.4 kg, i.e. 0.34% of the total solids (700 kg). In the Eurochemic plant, about 47 m^3 of typical HLLW (also called low enriched waste concentrate) has been transferred to the PAMELA vitrification facility. This

transfer did not meet with any problem whatsoever. The radioactivity of solids deposited in the form of a thin layer on the walls of storage tanks is difficult to eliminate and its presence complicates decommissioning operations.

In Marcoule, 2 270 m³ of HLLW have been transferred to the AVM plant and vitrified without any problem, producing 2 822 canisters. In La Hague, at the end of 2001, about 4 300 m³ of HLLW from UP2-400 and UP2-800 have produced 4 800 canisters in R7, and 3 300 m³ of HLLW from UP3-A have produced 3 500 canisters in T7. This is clearly, therefore, an activity which has reached industrial maturity.

The safety of HLLW storage is based essentially on preventive rather than remedial actions, as it is for all stages in the fuel cycle. This can be clearly observed in the design and construction of the storage tanks and the emphasis placed on system redundancy, quality assurance, and monitoring methods. Nevertheless, prevention cannot preclude the possibility of having to take remedial measures, and this possibility should not be neglected in safety assessments.

With regard to corrosion, laboratory tests under storage conditions and the results obtained in practice both indicate that corrosion rates are very low, even for internal components which may be subject to more aggressive conditions than the tank itself. Most tanks containing HLLW from LWR are made of stainless steel (AISI 304 or 316L). They have demonstrated very good resistance to corrosion in HNO₃ medium.

France has been acquiring significant experience in the field of HLLW storage over several decades. The inclusion of extra thickness in the design of tanks to allow for potential phenomena of corrosion, together with adequate tank cooling systems, has succeeded in ensuring the good resistance of this equipment over the long term, with corrosion rates of less than 5 µm/year. The effect of insoluble residues on corrosion resistance is important if hot spots with local temperatures above 100°C are observed. The concentration of fission products is also important, and should not exceed 200 TBq/l (about 5 000 Ci/l). It is advisable not to fall below a concentration threshold of 150 l/tHM to avoid crystallisation of the solution. The admissible concentration of HLLW lies between 5 m³/tHM and 500 to 300 l/tHM.

Alarm instrumentation is usually duplicated and includes:

- high and low liquid level alarms for the tank contents;
- measurement of the presence of radioactivity in the cooling water;
- sensors with an alarm in the sump;
- monitoring of the ventilation extraction system and gas flow;
- high temperature alarms;
- temperature sensors on the tank walls.

3. High-level solid waste

3.1 Solidification of waste

For HLW, the liquid form is not generally considered to be a final state. The conversion of this waste into a stable solid form appears to be indispensable for long-term storage and future disposal in safe conditions. Solidification aims to transform the aqueous solution of radioactive nuclides into a chemically, thermally, and radiolytically stable form. This process can also be applied to medium-level liquid waste [21].

The first step in this process may be calcination, with the aim of reducing the mobility and volume of the HLLW. The product remains partially water-soluble and is not suitable for either long-term storage or disposal. Some scientists recommend storage of the waste in this form, or conditioned using a more easily reversible process than vitrification, until a process can be developed to extract the long-lived radioactive nuclides, which could then be transmuted or conditioned in a more suitable way, this being much more difficult once the waste has been conditioned in glass [22]. Greater safety over the short term can be ensured by incorporating the calcined radioactive nuclides, present in the form of oxides, into a glass matrix by the addition of SiO_2 and B_2O_3 in the appropriate proportions. Stable matrices of borosilicate glass can be obtained by mixing 10 to 20% of radioactive oxides with 40 to 60% of SiO_2 and 10 to 30% of B_2O_3 , then heating the mixture to a temperature of around 1 100 to 1 150°C. A vitreous final state is chosen because it can be obtained safely and it possesses strong properties of resistance against environmental influences, although there is a possibility of devitrification at high temperatures (>600°C). Devitrification may lower this resistance. Other glass forming components such as Na_2O or CaO can be added, depending on the exact composition of the radioactive oxides. The addition of Al_2O_3 and other oxides influences the thermal stability and the melting point. HLLW can be added directly into the hot bath filled with molten borosilicates; this technique is based on heating the glass by its own electrical resistance (Joule effect).

A second type of solidification process, which has not found an outlet on an industrial scale, consists of mixing mineral compounds (notably those derived from ZrO_2 , TiO_2 and BaO) to form an insoluble crystalline matrix with the radioactive nuclide oxides. This process is carried out at high pressure and at temperatures of around 1 200°C. The resulting synthetic material SYNROC is thermodynamically stable in geologic strata.

The products of solidification resulting from either the vitrification process or the SYNROC process must be enclosed in leak-proof metal containers for interim storage. Stainless steel used are chosen for their good resistance to hot molten glass or for their use in hot isostatic pressing equipment as well as for their suitability for interim storage conditions, but they are not specifically selected for underground disposal. Additional measures should therefore be investigated for this purpose (engineered barriers either linked to the container such as metal over-containers or not linked to the container such as bentonite clay layer).

3.2 *Vitrification technology and experience*

Vitrification is the technique of reference throughout the world in the field of solidification and containment of HLLW. Two versions of this technique have been developed in France from the test bench through to industrial application. These two methods are based on the principle of calcinating the elements of the HLLW solution and then vitrifying the calcinated oxide into a matrix of borosilicate glass cast in a canister (Figure 8.6).

The first version of this vitrification process appeared in France in 1958 and led to the start-up of the first active pilot facility for HLLW vitrification, PIVER, in Marcoule in 1967. This facility was operated in batches, with the two operations of calcination and vitrification being carried out in the same equipment: a melting pot heated by induction. PIVER continued operating until 1972 and was dismantled at the beginning of the 90s. PIVER has received in September 1990 the US ANS "NUCLEAR HISTORIC LANDMARK" award as recognition of the advantages of the vitrification process.

Figure 8.6. Canister for vitrified HLW (Source: COGEMA – France)



The second version marked an evolution from batch processing to a continuous vitrification process, with the calcination and vitrification stages each being carried out in their own equipment (the calciner and then the melting pot, still heated by induction). The separation of these two functions enables more compact equipment to be installed and facilitates maintenance operations. The Marcoule AVM, designed on these lines and put into service in 1978, was the first industrial workshop in operation in the world; it is composed of a vitrification line with a glass production capacity of 15 kg/h. It has vitrified all the liquid waste produced by GCR fuel reprocessing at the UP1 plant in Marcoule, and its activities are now associated with the shutdown of this plant.

Using the experience acquired in the AVM, the vitrification technology applied in Marcoule was adapted to meet the different requirements of the La Hague reprocessing plants in terms of vitrification (increased capacity), and this has led to the design, construction, and start up of the vitrification workshops R7 in UP2-800 (1989) and T7 in UP3-A (1992) (Figure 8.7).

For this purpose, a full-scale inactive pilot of the La Hague industrial installations was constructed at the beginning of the 80s, to verify and validate all the technological aspects of operation before the start-up of the industrial workshops. Each of the vitrification workshops in La Hague is equipped with three lines of vitrification, and each line has a rated production capacity of 25 kg/h of glass. The volume of glass produced is from 100 to 120 l/tHM [23,24].

Figure 8.7. Vitrification plant in La Hague: inside view of one of the calcination and vitrification cells
(Source: COGEMA – France)

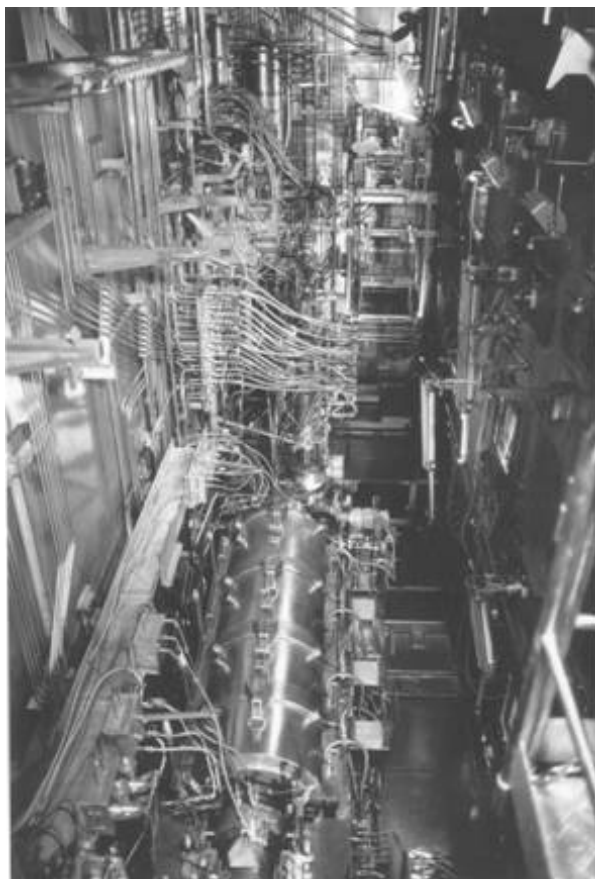

The containment glass produced in these workshops is a borosilicate glass with a reference composition containing 45% of SiO_2 , 14% of B_2O_3 , 10% of Na_2O , 5% of Al_2O_3 , and 12% of fission products and actinides, the remainder being composed of CaO , Fe_2O_3 , ZnO , Li_2O , ZrO_2 , NiO and P_2O_5 . This glass immobilises the radioactive nuclides by incorporating them to the intimate structure of the glass; it is thermally stable and displays strong resistance both to alteration under self-radiation and to leaching. Its characteristics have been submitted to chemical, physical, mechanical, and radioactive tests. In standardised test conditions, the leach rate in aqueous medium is less than 10^{-5} per year of leached fraction of material in saturated condition. The specification of this glass has been approved not only by the French Nuclear Safety Authority but also by those of utilities from other countries who are customers of the French reprocessing plants.

In the United Kingdom, WVP (Figure 8.8), put into service in Sellafield down-line from the THORP reprocessing plant, uses the French process, with a slightly different glass formulation also approved by the Safety Authorities of utilities from other countries who are customers of the English reprocessing plant [25].

Figure 8.8. Containers on rotary pouring station carousel of vitrification line 3 of WVP during inactive tests (Source: BNFL – UK)



Another technique of direct vitrification was developed in the Karlsruhe nuclear research centre in the 70s and the pilot plant – PAMELA – was subsequently built by DWK during the period 1981-84 on the Mol site in Belgium [26]. The plant came into active service in 1984 to vitrify HLLW from the former Eurochemic plant [27]. In this technique, the solution of radioactive nuclides is introduced directly into the bath of molten glass without prior calcination [28]. During the vitrification campaigns in the PAMELA plant, a gradual rise in the concentration of platinum on the bottom of the glass melter was recorded. The melter was replaced in 1986 without major problem. Operation ceased in 1991, after having treated all the HLLW produced by the Eurochemic reprocessing plant. This resulted in 2 201 glass canisters corresponding to around 480 t of vitrified waste.

Similar prototype plants have been constructed in the United States in the NFS West Valley plant [29] and will be built in Hanford. A vitrification plant (DWPF) is in operation at the Savannah River site.

In Japan, PNC began research into vitrification techniques in 1975 with small-scale tests in Tokai mura. Active vitrification on a laboratory scale began in the Tokai CPF in 1982. Work on the design of a vitrification plant for the same site using a PAMELA-type process began in 1980; PNC started cold testing of the plant in 1992. It has now been in service since January 1995 and had produced 130 canisters by October 2003.

The SYNROC process has been the subject of fundamental research and the results of some laboratory-scale work have been published [30]. The composition of the material has to be adapted to the form of the waste, and as only the treatment of military waste has been envisaged it is very difficult to use these results for acid solutions of HLLW. Nonetheless, the final product is composed of four crystalline elements: nepheline, perovskite, zirconolite, and spinel and its main advantage is thermodynamic stability. The technological concept proposed includes, as a final step, hot pressing at a temperature of about 1 100°C and at a pressure of between 70 and 140 bars, which might cause problems during application of the process to highly radioactive material.

3.3 Safety considerations

The characteristic shared by almost all HLW solidification processes is that they require the use of high temperatures and, therefore, important off-gas cleaning systems to trap the most volatile radioactive nuclides which may be released by the fed solutions. The semi-volatile radioactive nuclides likely to be released during high-temperature processes are principally caesium, antimony and ruthenium, but also selenium, technetium and tellurium. To retain them, a series of off-gas cleaning systems must be installed. The most common are dust scrubbers, high temperature condensers, jet scrubbers or washing towers using appropriate scrubbing liquids, fibreglass pre-filters, and HEPA filters. Although the DF of each off-gas cleaning system is only moderate, their total overall effect is very substantial: experimental tests in carefully controlled conditions have measured DFs of more than 10^6 for each of the nuclides listed [31].

Table 8.1 gives the DFs recorded in normal operating conditions for prototype plants in hot operation such as PAMELA and AVM.

Table 8.1. Decontamination factors in operation – Vitrification pilot plants

	PAMELA	AVM
^{106}Ru	1.3×10^8	6×10^7
^{125}Sb	2.5×10^8	–
^{137}Ce	–	3×10^8

These results indicate quite clearly that vitrification operations have negligible radiological impact on the environment, on the condition that each off-gas cleaning system is maintained in adequate operating order. Safety analyses show that the most significant accidents would originate in the complexity of the off-gas cleaning systems required by the high temperatures involved [32]. Principally, they would result from errors in condenser operation. These accidents might lead to a discharge of semi-volatile fission products and have a radiological impact of the same order of magnitude as the annual dose commitment from routine discharge of the vitrification plant. A loss of negative pressure in one of the R7 calciners in La Hague in 2001 led to a discharge of this nature. It is also considered that the effects of explosive reactions in the process equipment (calcliner, melting furnace) would not contribute significantly to the overall risk.

Up to the present day, no reaction of this type has been recorded for the cumulated total period of more than 50 years during which vitrification plants have been in active operation in France, the United States, the United Kingdom, Japan and the German plants installed in Belgium.

The potential for a serious incident occurring during handling of the HLLW fed into the process or during operation of the calciner and glass melting furnaces is limited, as the feed rate is relatively

low (40 to 60 litres of HLLW per hour). At this rate, the discharge and dispersion of radioactivity from the waste would be limited to the process equipment or, in the event of a more serious incident, to the containment structures.

The most serious safety problems to have been encountered are caused by progressive contamination of mechanical equipment such as overhead cranes, manipulators, etc., which must be repaired or removed from the hot cells from time to time. To deal with these problems, the new vitrification plants (R7/T7 and the WVP) are equipped with separate maintenance cells, a very sophisticated remote manipulation system, and fully automatic equipment wherever possible. After a first campaign in the PAMELA plant, a melting furnace was dismantled by remote manipulation and replaced by a new one without any major problem.

The decision of filling the containers with glass by overflow casting or by underflow using a glass solidification valve has no direct incidence on safety, but since blockages of such valves have been reported, it is important to equip the furnace with redundant or remotely operable outlets.

The composition of the radioactive oxide influences the overall behaviour of the melting furnace and the quality of the glass. Platinoids and molybdates in particular display very limited solubility in borosilicate glass [32]. The addition of insoluble residues to the glass must be carefully controlled to obtain suitable incorporation and to avoid local accumulation.

In France, the overall load rate for containment glass is on the order of 25% by mass. Specific limits have been placed on the proportion of oxides of (PF + Zr + actinides + metallic particles) and on the level of activity of certain fission products in order to respect the domain of chemical composition of the containment glass, to take into account the production of heat within the glass, and to maintain temperature in the core of the glass block, in storage, less than 510°C. This limit provides a margin of 100°C in relation to the temperature of about 610°C at which the vitreous state of the glass begins to change (devitrification process), although prolonged thermal treatments have already demonstrated over 100 hours the low sensitivity of the glass to these phenomena. Furthermore, the external labile surface contamination of the canisters is strictly limited to prevent any spread of contamination and to facilitate storage and transport operations.

3.4 Preventive and remedial measures

The usual actions must be taken to prevent leaks from tanks and pipes and to limit the consequences if such a leak should occur. Appropriate instrumentation for the control and monitoring of the process should be installed for early detection of any equipment failure.

4. Fuel cladding waste – shearing and clarification residues

Besides HLLW, current spent fuel reprocessing plants also produce other high-level solid wastes:

- Fuel element cladding, either pieces of Magnox swarf from Magnox fuel or hulls of stainless steel or Zircaloy from oxide fuels.
- Some structural elements from fuel assemblies, such as graphite sleeves, stainless steel or zirconium grids, top and bottom stainless steel end-pieces, etc.

- Solid residues, most of which remain in the dissolver but which may be carried down line and recovered during clarification. These residues are composed of little pieces of cladding, insoluble fission products and a small quantity of fuel particles.

Magnox waste is collected under water during the head end operations and is transferred, also under water, to interim storage facilities (see Section 9-2.2). Handled under these conditions it does not represent any fire hazard.

During the head-end operations in oxide fuel reprocessing, a quantity of solid waste is produced by the chop and leach process. Shearing produces small lengths of fuel encased inside pieces of cladding, but also oxide fines and a metallic powder originating in crushed fuel and cladding tubes. As the cladding material used for LWR fuel is Zircaloy, the fine powders contain zirconium metal fines [33]. Stainless steel waste does not represent a fire hazard and will not be examined any further in this Section; its storage is discussed in Section 9-2.3. The rest of this Section will be devoted mainly to solid waste from LWR.

After dissolution, the solid residues are extracted from the dissolver liquor and washed to eliminate particulate material. The washed hulls constitute an important category of waste which must be treated in a proper way to avoid any untimely discharge of radioactivity. Insoluble residues and certain metallic fines are removed from the dissolver liquor by centrifugation or filtration. Some fission products and fissile materials and about 50% of the tritium are attached to the hulls and plated on the inner surface of the washed hulls, with insoluble residues containing essentially poly-metallic inclusions of ruthenium, rhodium, palladium, and technetium, together with chemically unstable fission products.

Between 3 to 4 kg of insoluble residues per tHM [34,35] are produced during head end operations during the reprocessing of LWR reference fuel. Because of the presence of ^{106}Ru and other relatively short-lived fission products, these residues release a high specific thermal power which varies between 0.3 and 1 kW/kg depending on the cooling time. They take the form of a fine powder, with a grain structure of between 0.1 and 50 μm depending on the length of dissolution time, and are mixed with Zircaloy powder. The centrifugal decanter bowls and/or filtration equipment may require continuous cooling (notably for FBR fuel) to prevent self-heating and pyrophoric reactions at high temperature in the presence of air. The problem of self-heating becomes less crucial, however, when the fuel has been cooled long enough, which is presently the case for the reprocessing of LWR reference fuel.

When filtered or centrifuged solids are extracted in the clarification unit, their interim storage conditions must include a cooling system or an oxygen-free atmosphere. Possible spontaneous ignition of the zirconium and Zircaloy fines associated with the insoluble residues is due to the chemical affinity of zirconium for oxygen. The pyrophoric properties of Zircaloy powders depend on a number of factors: presence of oxygen, temperature, particle size, critical mass, and dilution by other non-pyrophoric substances.

The insoluble residues collected during clarification are generally stored under water. The conditions of storage must be subject to rigorous monitoring and control to prevent overheating. These insoluble residues can be encapsulated in concrete for disposal or mixed with HLLW to be vitrified. The best means of keeping open the long-term possibilities offered by these platinoids would be to store them separately [36]. Some research has already taken place into the feasibility of separating noble metals from residues [37,38]. However, no commercial outlet has yet appeared, due to the difficulty of extraction.

When the residues are mixed with the other components of the glass during the vitrification process, their average level of concentration in the glass and their dispersion in the block of glass must be rigorously controlled to avoid any local accumulation [32].

The Zircaloy hulls are carefully washed when they come out of the dissolvers. Their fissile material content is checked and they are then immediately encapsulated (e.g. in UP2-800 and UP3-A plant) or transferred to interim storage in a pool until they can be conditioned according to the rules of good practice (in the case of the UP2-400 plant) or transferred to a specialised unit for encapsulation (in concrete in the case of the THORP plant). The hulls produce little heat, contain a certain quantity of fissile material, and display a high rate of gamma activity which justifies remote manipulation in specially equipped facilities.

As for 2003, at La Hague, about 1 600 tonnes of hulls and end-pieces are in interim storage in UP2-400 awaiting conditioning, and nearly 5 000 drums have been conditioned or pre-conditioned in-line in UP2-800 and UP3-A, representing about 4 500 tonnes of hulls and end-pieces. Their plutonium content is between 1 and 10 g/t and the activity of actinides trapped in the Zircaloy cladding is between 0.3 and 4 TBq/t. The main fission products present are caesium (137/134) and ¹²⁵Sb, the activity of which is, however, negligible compared with that of the ⁶⁰Co which results from neutron activation (37 to 74 TBq/t). All these values are given per tonne of hulls.

These data lead to the conclusion that gamma examination of washed hulls cannot give any indication of the residual fissile material content, and that other methods must be used, such as neutron interrogation. This is what has been introduced in France in the UP2-800 and UP3-A plants, in which active and passive neutron interrogation are combined.

Zircaloy hulls have a high tritium content which represents between 40 and 60% of the total quantity of tritium produced in the reactor. Any process leading to the release of hydrogen or the oxidation of hydrides will release this inventory of tritium. The safety analysis of conditioning units must take this phenomenon into account to forecast the tritium discharge rate.

Different methods of conditioning Zircaloy cladding hulls have been studied:

- encapsulation in cement-type materials;
- high-pressure compaction and encapsulation in lead or graphite;
- melting the Zircaloy (forming ingots) [39];
- encapsulation in a glass matrix.

Encapsulation in cement-type materials is the basic solution for industrial practice proposed in the United Kingdom and, initially, in France [40]. This method consists of conditioning the Zircaloy hulls in bulk in a Portland cement grout inside a 1.4 m³ stainless steel container (4 000 kg total weight).

A similar technique, but preceded by partial rolling compaction, enables the volume of hulls to be reduced, but the physico-chemical and radiological phenomena remain unchanged. The process was proposed in Germany and the products were tested on a representative scale using hulls from the WAK plant. It appears that the radiolysis of the water in the concrete can result in a partial release of hydrogen and tritium. The effects of this phenomenon on safety during storage and disposal must be assessed.

Other hull conditioning techniques have been developed in Germany, Belgium, and France [41,42,43,44]:

- High-pressure compaction and encapsulation in low melting point alloys have been studied and tested on a laboratory scale with active hulls. The liquid metals dissolve the fission products and create a permeable matrix. The use of a mixture of sulphur and graphite as encapsulating material for the compacted hulls could improve homogeneity. This compaction-encapsulation process tends to be replaced by a process of compaction-containerisation which has the advantage of reducing the volume even further (up to a factor of 4 to 5) without any gaseous discharge. This latter process has now been adopted in France.
- The process of melting the alloy of 75% Zircaloy and 25% copper at high temperature (1 100°C) has been the subject of active tests on a laboratory scale, and enables the volume to be reduced even further (up to a factor of 5 to 7) but requires the manipulation of a relatively pyrophoric material at high temperature. The tritium inventory is almost entirely discharged during this process. This discharge must therefore be dealt with in conditions of safety as regards protection of the environment.
- The encapsulation of hulls in borosilicate glass has been tested on a laboratory scale, but does not lead to a stable and reproducible matrix.

5. Medium-level waste containing plutonium

Waste contaminated by plutonium is mainly produced during spent fuel reprocessing, plutonium conversion, and the production of MOX fuel. This waste must be processed according to its specific characteristics to transform it into a disposable form. In fuel reprocessing, plutonium is accompanied by fission products and minor actinides, whereas in the conversion of plutonium and above all in the production of MOX fuel, ^{241}Am is the main daughter product of actinides, formed by the decay of ^{241}Pu and emitting gamma rays.

Reprocessing operations produce a series of waste contaminated by plutonium which must be processed separately [45]:

- washing solutions from used solvent (plutonium + fission products);
- aqueous concentrates resulting from distillation;
- various solid materials (combustible and non combustible).

The recovery rate for uranium and plutonium in La Hague is 99.88%, meaning that 0.12% is lost in glass and other waste, most of it in the glass.

5.1 Treatment and conditioning methods

Liquid waste is either concentrated by evaporation and then vitrified with the HLLW (present French process) or processed chemically by co-precipitation and flocculation; the resulting sludges are dehydrated and stored before being encapsulated in bitumen (former French and Japanese processes), cement (United Kingdom) or solidified with sodium borate (Japan).

The Japanese process implemented at Tokai mura in LWTF (Low level radioactive waste treatment facility) dries by evaporation as well the sludges resulting from flocculation as the

supernatant liquid, after the addition of sodium borate ($\text{Na}_2\text{B}_4\text{O}_7$). The dry mixture is filled in drums where the sodium borate hydrate ($\text{Na}_2\text{B}_4\text{O}_7 \cdot n\text{H}_2\text{O}$) becomes naturally solid as it cools. The hydrate is non-combustible, which is not the case for bitumen formerly used.

Approximately 18 m^3 of bitumen is produced per GWy of electricity produced by the fuel. It is conditioned in 100 containers of 0.25 m^3 each [46] (Figure 8.9). The most serious hazard is a fire during the filling of the drum and during the drum cooling stage [47]. The fire potential is linked to various factors, such as:

- a pouring temperature close to the flammability range of the bitumen;
- potential reactivity of the bitumen compound (salts/bitumen or salts/salts reactions);
- poor thermal conductivity of the bitumen compound;
- high viscosity of the bitumen compound.

Figure 8.9. Bitumen drums filling station in STE3 facility (La Hague) (Source: COGEMA – France)

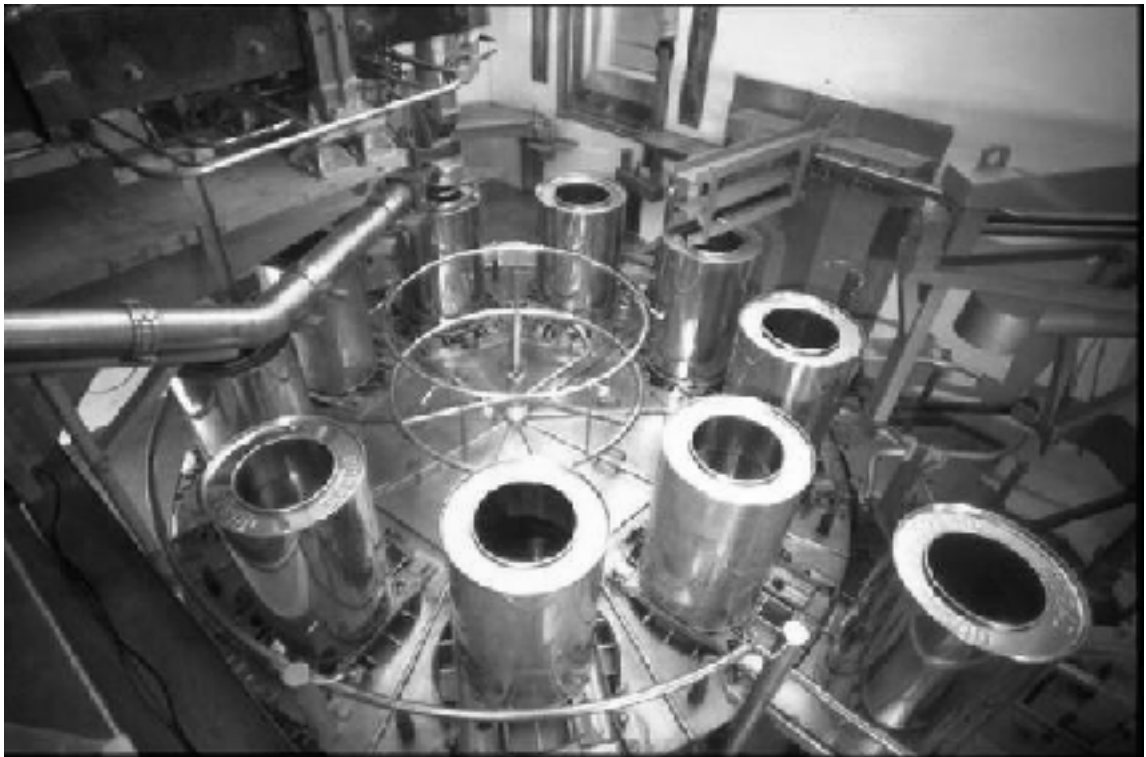

Every recorded case of fire has started in the drum, except in one instance when the overflow burned. The latency time before overflowing or fire is variable and can be as long as 15 hours, accompanied by the production of considerable quantities of smoke before the flames appear. One fire was recorded in the Eurochemic plant in Mol [48] in 1981. It was extinguished within a few minutes without external contamination or exposure of the operators. This incident resulted in particular attention being paid to the composition of batches in relation to exothermic reactions. Another fire was recorded in the JNC plant in Tokai mura in 1999 (See Section 12-3). An assessment of the thermal reactivity of encapsulated materials and the definition of a safe operating range were carried out before

start-up of the STE3 facility in La Hague to prevent start of fire. In addition, fire detection and multiple extinguishing systems to control fires have been designed and installed [47].

Bituminous waste generate hydrogen by radiolysis. The accumulation of gas in the drums and emitted by them, a potential for fire and explosion, is prevented by:

- limiting the activity content in the drum;
- installing a sintered steel filter on the drum;
- ventilating the storage room and continuous monitoring its atmosphere.

The first measure is the most important, for the hydrogen produced in the mass of bitumen must be able to escape from the bitumen to be evacuated by slow bubbling. If the level of activity is too high and the production of hydrogen too great, the bitumen may swell and cause deformation of the drum or even overflow.

The potential safety hazards presented by these phenomena have therefore been overcome. However, the very high specific volume of bituminous waste has, for essentially economic reasons, led the French operator to seek a more compact form of conditioning, less expensive in terms of transport, storage and disposal. The process chosen consists of concentrating the waste by evaporation and transferring the resulting sludge to the vitrification facility, where the subsequent increase in the volume of glass is negligible (of the order of one container per year for a plant of 800 tHM/year).

The drums of bitumen already produced are stored in specific installations awaiting evacuation.

Solid waste contaminated by plutonium is produced during all stages of the process, but more particularly during the conversion of plutonium solutions into PuO_2 or $(\text{U-Pu})\text{O}_2$ and the subsequent conditioning process. This waste is present in diverse forms such as paper, cloth, rubber gloves, contaminated equipment, etc.

Various methods have been developed to process solid waste contaminated by plutonium, with the aim of reducing the volume and/or recovering part of the plutonium present. These methods include compaction, incineration, acid digestion, and acid leaching.

Combustible waste with low plutonium content can be burned in high-temperature incinerators: this can include papers, solvents, and organic matters. Several types of incinerator have been developed and are available, the safety problems inherent in their operation residing mainly in the stages of off-gas purification and conditioning of the ashes [49]. The corrosion of the gas purification equipment by HCl and other acids and the clogging of the filter beds by airborne particulates are the main malfunctions encountered. The construction and maintenance of high-temperature incinerators is a complex domain requiring a comprehensive design-stage survey of safety, maintenance, and decommissioning aspects to avoid any mishap once the incinerator is contaminated by plutonium.

Acid digestion [50,51] has been the subject of exhaustive studies with the aim of recovering quantities of plutonium from combustible waste of the Eurochemic plant. About 600 kg of waste has been processed and 5 kg of plutonium has been recovered, representing a recovery rate of 97 to 98%. A similar installation has been built and put into service in Hanford, but worked with lower initial plutonium concentrations. This process can treat plutonium from both fuel production plants and reprocessing plants. However, acid digestion uses concentrated HNO_3 and H_2SO_4 acids, which oxidise organic material and dissolve mineral material, and requires temperatures that can reach 250°C . The digestion is followed by a liquid-liquid extraction of the aqueous solution of $\text{Pu}(\text{SO}_4)_2$. The safety

problems encountered with this technique are numerous: use of highly corrosive acids at high temperatures, deposition of $\text{Pu}(\text{SO}_4)_2$ in the pipes, criticality limit in the design and low output of material. The technological feasibility has been proven, but in the meantime these installations have been decommissioned due to the technical difficulties encountered in maintaining the process material in good condition over a long period of time.

Metallic waste contaminated by plutonium can be washed with acid, but electro-chemical processing has proved to be more efficient in reducing the residual contamination of metallic parts (glove boxes, process equipments, etc.). Usual chemical decontamination using acid (H_2SO_4) followed by alkaline oxidation (NaOH-KMnO_4) is very efficient in reducing the surface contamination of metals, but it produces large volumes of liquid waste to be treated. The Ag (II) electrochemical decontamination process used in the UCD unit at La Hague should be noted [52,53].

Electrochemical decontamination, also known as electro-polishing, has been tested on a laboratory scale and validated in a prototype installation of the size of large nuclear material [54]. DF of 10^4 can be rapidly achieved and the recycling of the decontamination electrolyte reduces the overall waste production to low final volumes [55]. This method is very promising and already very efficient in the UCD, for reducing the volume of technological waste [56].

Technological waste comes from reprocessing plant equipment that has been removed and replaced by new components. This contaminated equipment can be decontaminated, sometimes compacted and/or embedded in cement matrices [57,58,59]. In principle these operations do not present any specific risk during conditioning. However, if the technological waste is highly contaminated or contains large quantities of organic material and/or plutonium, radiolysis can occur and gas can form. The long-term structural behaviour of technological waste containers must be subject to careful investigation focused on the preliminary evaluation of disposal safety.

The spent solvents resulting from the TBP used in the PUREX process extraction and any other extraction agents used to purify plutonium constitute a particular category of organic waste. The large-scale use of TBP produces large volumes of used solvent contaminated by plutonium, actinides, and certain fission products. The radioactive contaminants and undesirable solvent decomposition products can, however, be extracted by washing with solutions containing alkaline salts or hydrazine and then distilling at low pressure. Most of the solvent can therefore be recycled into the process, but a certain proportion remains unused and is treated as waste.

Different methods have been proposed for processing these organic solutions:

- direct injection into an incinerator and combustion [49];
- pyrolysis in the presence of $\text{Ca}(\text{OH})_2$ and combustion of butane [60,61];
- oxidative decomposition by peroxide treatment and neutralisation with $\text{Ca}(\text{OH})_2$ [62];
- direct treatment with AlCl_3 and conditioning of aluminium phosphate [63];
- distillation at low pressure as a method of recycling the solvents [64].

This method is used in the UP2-800 and UP3-A plants (organic effluents treating unit). The residue recovered is mineralised in the specialised unit MDS (Figure 8.10) before evacuation [65].

Figure 8.10. MDS: Combustion chamber (Source: COGEMA – France)

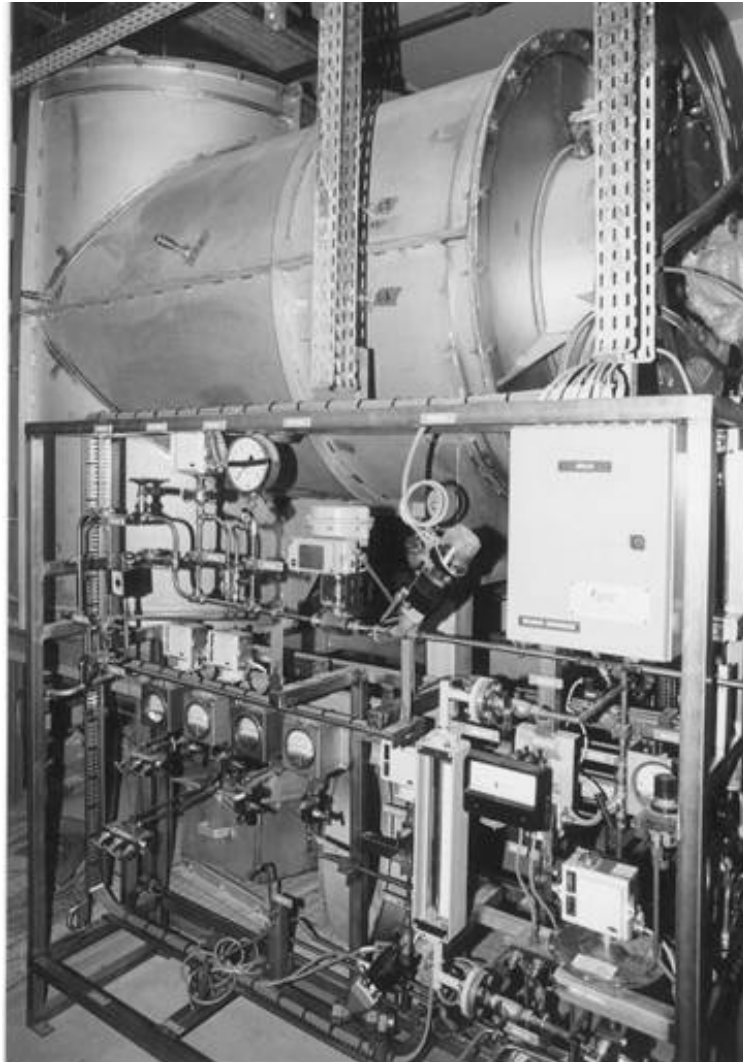

6. Management of gaseous effluents

Gaseous radioactive nuclides are released when spent fuel is sheared during the head-end mechanical operations in the reprocessing plant and during dissolution of the fuel:

- tritium and ^{14}C are partially dissolved in the fuel and cladding and a fraction only is released;
- ^{85}Kr is released during head-end operations;
- iodine is released during dissolution of the fuel.

Tritium, produced by ternary fission in the fuel, migrates during irradiation to the cladding and there reacts with the zirconium to form ZrH_2 , a compound that displays a certain thermal stability. Some of the tritium remains in the fuel pellets. During dissolution operations about 45 to 65% of the

tritium penetrates into the aqueous solution and accompanies the solution fed into the liquid extraction process. The rest remains in the hulls in the form of ZrH_2 and undergoes solid waste processing operations. Methods have been developed to reduce the transfer of tritium from the dissolver solution to the liquid extraction process [66]. The La Hague plants use one such method. In the 1980s, moreover, important technical progress was made in the field of extracting tritium from aqueous effluents, and this has reached the stage of pilot installations [67,68,69]. However, as most reprocessing plants are located near the sea they have not sought to retain the tritium, as the very high physical and isotopic dilution capacity of the surrounding sea waters is sufficient to meet radiological protection standards and such retention is unnecessary in terms of the ALARA principle. This is not the case for discharge into the atmosphere, which explains the efforts made to retain the maximum amount of tritium in the aqueous effluents.

About 60% of the ^{14}C contained in the spent fuel is discharged in the form of CO_2 , whereas 40% remains in the hulls, as it is produced by neutron activation of the ^{14}N present in the form of impurity in the Zircaloy [70]. The CO_2 released from the dissolver can be trapped, as is the case in the THORP plant, by scrubbing with caustic soda and then precipitating out the carbonate by reaction with barium nitrate solution. In the La Hague plants, most of the ^{14}C is trapped by scrubbing with soda and a large proportion is released into the sea with the soda solution, which also contains ^{129}I . The rest is released into the atmosphere. Furthermore, it may be advisable not to destroy the metallic structure of the hulls, by melting for example, to keep the ^{14}C trapped in the hulls. Consequently, a complete and careful evaluation is necessary to get the best balance between encapsulation, with or without melting, and discharge.

Numerous studies have been carried out into the retention and immobilisation of ^{85}Kr from head-end off-gases [71,72,73]. Krypton is released as a gaseous fission product during mechanical and chemical head-end operations. Its radiological impact has been carefully assessed [74,75] and found to be insignificant. Another reason for the decrease of interest in krypton trapping methods resides in the technical complexity of the successive preliminary stages of process (extraction of moisture, oxygen and nitrogen oxides) that may require, among other things, the use of hydrogen gas.

Finally, the separation techniques lead to the formation of a very concentrated fraction of krypton, absorbed by activated charcoal or zeolites, which must be placed in interim storage for a relatively long time (half-life 10.5 y) to decay. The interim storage of large quantities of ^{85}Kr can be considered to present a local radiological hazard greater than the overall impact caused by continuous dilution in the reprocessing plant stack. This situation would need to be re-evaluated if the world capacity of reprocessing plants should increase significantly.

Application of the ALARA principle should be the basis of any decision-making concerning the retention of ^{85}Kr .

Iodine, ^{129}I in particular, is the only volatile radioactive nuclide that is generally trapped in the treatment of gaseous effluents of reprocessing plants. It is discharged during dissolution of the fuel and trapped by alkaline scrubbing solutions and/or absorbers impregnated with silver [74,75,76]. A small quantity of ^{131}I is generated in the process by the spontaneous decay of ^{244}Cm [77]. It is trapped in the zones in which it is released, using solid traps which are evacuated as waste.

7. References

- [1] High Level Nuclear Waste Disposal (1986), edited by H.C. Burkholder, ANS International Topical Meeting on High Level Nuclear Waste Disposal, Pasco 1985, Batelle Memorial Institute 1986, ISBN-0-935470-29-8.
- [2] NEA (1989), Proceedings of the International Symposium on the Safety Assessment of Radioactive Waste Repositories, October 1989, OECD, Paris, pp. 9-12.
- [3] Faugères, J. (2000), "SOCODEI Melting, Recycling and Incineration Facilities", SAFEWASTE 2000, Montpellier.
- [4] Moulin, J.P. *et al.* (1991), "Advanced Techniques for Analytic Wastes Management in the Rokkasho Reprocessing Plant", RECOD-91, Vol. 1, pp. 100-105.
- [5] Ducos, O. *et al.* (1991), "New Evaporation Facility for Liquid Waste Treatment at Marcoule", RECOD-91, Vol. 1, pp. 112-116.
- [6] Lefèvre, J. *et al.* (1991), "French Reprocessing and Waste Management Research and Development", RECOD-91, Vol. 1, pp. 241-246.
- [7] Kikuchi, M. *et al.* (1991), "Advanced Solidification Technique Using Cement-Glass", RECOD-91, Vol. 1, pp. 407-412.
- [8] Hirose, Y. *et al.* (1991), "Electrochemical Processing of Low Level Liquid Radioactive Waste", RECOD-91, Vol. 2, pp. 735-740.
- [9] Maurin, G. *et al.* (2000), "The ECC Compacted Waste Interim Storage Facility Using the Universal Canister Concept in La Hague, France", Waste Management 2K, Tucson.
- [10] Hugon, M. (CEC) (1994), "Potentialities of Partitioning and Transmutation for Nuclear Waste Management", RECOD-94, Londres, 1, Session 7A.
- [11] Adnet, J.L. *et al.* (1998), "The Development of the SESAME Process", RECOD-98, Nice, Vol. 1, pp. 432-439.
- [12] Rouyer, H. (1994), "The French Law on R&D at the Back End of the Fuel Cycle in the Nuclear Industry – Consequences and Effects", RECOD-94, Londres, 3, Session 7A.
- [13] Baetsle, L.H. (1994), "Limitations of Actinide Recycle and Waste Disposal Consequences – A Global Analysis", RECOD-94, Londres, 5, Session 7A.
- [14] Madic, C. *et al.* (1994), "Actinide Partitioning from High Level Liquid Waste Using the DIAMEX Process", RECOD-94, Londres, 1, Session Actinide Separation.
- [15] BNFL Storage of HLLW (2000), "The Storage of Liquid High Level Waste at BNFL Sellafield, An Updated Review of Safety", A Report by HM Nuclear Installations Inspectorate, published by Health & Safety Executive, February.
- [16] IAEA (1979), "Handling and Storage of High Level Radioactive Liquid Wastes Requiring Cooling", TECDOC-191, Vienna.

- [17] Philippe, M., Mercier, J.P. and Gué, J.P., “Behavior of Ruthenium in the Case of Shutdown of the Cooling System of HLLW Storage Tanks”, Proceedings of the 21st DOE/NRC Nuclear Air Cleaning Conference, San Diego.
- [18] Becker, R. *et al.* (1980), “Radiolytically Generated Hydrogen from PUREX Solution”, Management of Gaseous Wastes from Nuclear Facilities, IAEA, Vienna.
- [19] Fang, D. *et al.* (1980), High “Level Waste Concentrate Storage at WAK, in Management of Gaseous Wastes from Nuclear Facilities”, IAEA, Vienna.
- [20] Bacherlay, L. *et al.* (1987), “Materials Reliability in the Back End of the Nuclear Fuel Cycle HLLW Storage Tank Materials”, IAEA-TECDOC-421, pp. 83-96.
- [21] Moncouyoux, J. *et al.* (1991), “New Vitrification Techniques”, RECOD-91, Vol. 1, pp. 307-311.
- [22] Commission Nationale d’Évaluation (1998, 2000), Rapport d’Évaluation No. 4, Octobre 1998; Rapport d’Évaluation No. 5, Juin 1999; Rapport d’Évaluation No. 6, Juin 2000, pp. 7-8.
- [23] Jouan, A., Terki, M., Pacaud, F. and Moncouyoux, J.P. (1987), “Research and Development Status of the French Vitrification Process”, RECOD-87, Vol. 1, p. 289.
- [24] Masson, H. *et al.* (1999), “R7/T7 Vitrification at La Hague: Ten Years of Operation”, International Symposium on Technologies for the Management of Radioactive Waste from Nuclear Power Plants and Back End Nuclear Fuel Cycle Activities, Taejon.
- [25] Woodall, A. and Elsdén, A.D. (1986), “The Design and Construction of the Windscale Vitrification Plant and Vitrified Product Store”, ENC-4-FORATOMIX, Vol. 4, pp. 469-476.
- [26] Hohlein, G. *et al.* (1986), “High Level Waste Vitrification in a Ceramic Lined Glass Melter”, ENC-4-FORATOMIX, Vol. 4, pp. 633-639.
- [27] Kaufman, F. and Wiese, H. (1987), “Vitrification of High Level Liquid Waste”, RECOD-87, Vol. 1, pp. 279-288.
- [28] Kulin, K.D. *et al.* (1991), “High Level Liquid Waste Conditioning in the PAMELA Plant”, RECOD-91, Vol. 1, pp. 273-277.
- [29] Knabenshub, J.L. (1987), “Start Up of the West Valley High-Level Waste Conditioning and Vitrification System”. RECOD-87, Vol. 1, p. 263.
- [30] Campbell, J.H. *et al.* (1982), “Incorporation of High Level Wastes in SYNROC, Results from Recent Process Engineering Studies at Lawrence Livermore National Laboratory”, *Scientific Bases of Nuclear Waste Management V*, edited by W. Lutze, North Holland, pp. 300-308.
- [31] Klein, M., Weyers, C. and Goossens, W.R.A. (1985), “Off-Gas Cleaning of a Liquid Waste Vitrifier”, Proceedings European Conference Gas Effluent Treatment in Nuclear Installations, Luxembourg, p. 777.

- [32] Pentinghaus, H. (1989), "On the Process Chemistry of HLLW Vitrification in a Liquid Fed Ceramic Melter", *Safety in the Nuclear Fuel Cycle*, edited by K. Ebert and R. Von Ammon, pp. 230-238.
- [33] Baetsle, L.H. (1989), *Review of the Fire Hazards in Reprocessing Plants, Fire Protection and Fire Fighting in Nuclear Installations*, IAEA-SM-305-7, pp. 373-387.
- [34] Gué, J.P. (1984), « Détermination de la composition et de la radioactivité des coques provenant du traitement industriel des combustibles des réacteurs à eau légère 'opération coquenstock' », Rapport EUR 10923 FR.
- [35] Gué, J.P. (1987), « Principales caractéristiques des déchets solides de haute activité en tête du procédé PUREX », RECOD-87, Vol. 2, pp. 607-610.
- [36] IAEA (1989), "Feasibility of Separation and Utilization of Ruthenium, Rhodium and Palladium from High Level Wastes", IAEA, Technical Reports Series No. 308, Vienna.
- [37] Naito, S. *et al.* (1991a), "Recovery and Mutual Separation of Noble Metals from Simulated Insoluble Residue of Spent Fuel", RECOD-91, Vol. 2, pp. 633-638.
- [38] Moriyama, H. *et al.* (1991), "Pyrochemical Recovery of Fission Product Noble Metals from Simulated Insoluble Residue of Spent Fuel", RECOD-91, Vol. 2, pp. 639-643.
- [39] Berthier, P. *et al.* (1994), "Reducing the Radiotoxicity of PWR Cladding Hulls by Cold-Crucible Melting", RECOD-94, Londres, 3, Session 9A.
- [40] Lewis, H.G. *et al.* (1991), "Encapsulation of Reprocessing Waste in a Cement Matrix", RECOD-91, Vol. 1, pp. 404-406.
- [41] Frotcher, H., Grabner, H., Kapulla, H. and Vegmelka, P. (1986), "Untersuchungen zur Fixierung von BE Hulsenabfallen mit Wasserarmen Keramische Zementen", EUR 10892 DE.
- [42] Schmidt-Hausberg, T.H. (1986), "Konditionierung von Brennstoffhulsen durch Einbettung in Metallische Werkstoffe und Graphit Matrix", EUR 10384 DE.
- [43] De Regge, D. (1986), "Conditioning of Cladding Waste for Long Term Storage by Press Compaction and Encapsulation in Lead", EUR 10924 EN.
- [44] Mazoyer, R. and Vernaz, E. (1986), « Conditionnement des Déchets de Gains de Combustibles Irradiés par Fusion Eutectique et par Enrobage par le Verre », EUR 10702 FR.
- [45] IAEA (1980), "International Nuclear Fuel Cycle Evaluation", Vienna.
- [46] Venet, P. and Haytinck, B. (1988), « Coûts et Modes de Financement de l'Évacuation Géologique des Déchets Radioactifs », EUR 11837 FR.
- [47] Canel, A. (1989), "Fire Risk in the Liquid Effluent Treatment Station (STE 3) at La Hague, Fire Protection and Fire Fighting in Nuclear Installations", Proceedings, IAEA-SM-305/42, p. 421, Vienna.

- [48] Meyers, H. and Claes, L. (1989), "Status of the Eurochemic Waste Management Programme and Related Safety Aspects", Nuclear Fuel Cycle Safety Work Group.
- [49] Dietrich, G., Gomoll, H. and Lins, H. (1987), "Incineration of Dry Burnable Waste from Reprocessing Plants with the Julich Incineration Process", RECOD-87, Vol. 2, p. 785.
- [50] EUR 8609 (1983), *The Acid Digestion Process for Radioactive Waste*, edited by L. Cecille and R. Simon.
- [51] Lederbrink, F.W. *et al.* (1985), "Plutonium Recovery from Alpha-Wastes", *Radioactive Waste Management and Disposal*, edited by R. Simon, EUR 10163, pp. 134-145.
- [52] Kniebihli, B. *et al.* (1998), "The Centralized Alpha Waste Treatment Facility (UCD) at La Hague", RECOD-98, Vol. 3, pp. 939-946.
- [53] Poncelet, F.J. *et al.* (1994), "Industrial Use of Electrogenerated Ag II for PuO₂ Dissolution", RECOD-94, Londres, 1, Session Fuel Dissolution and Residues Characterization.
- [54] Turner, A.D. *et al.*, "Development of Remote Electrochemical Decontamination for Hot Cell Applications", AERE-R-12764.
- [55] EUR 12690 (1989), *Decommissioning of Nuclear Installations*, edited by K. Pflugrad *et al.* Brussels, October 1989, 858 pages.
- [56] Audemar, A. *et al.* (1999), "French Experience in Silver II Dissolution Process", 23rd Annual Actinide Separations Conference, Kennewick.
- [57] Boudry, J.C. (1988), « La Gestion des Déchets de La Hague: Traitement, Conditionnements, Contrôles », *Revue Générale Nucléaire*, No. 4, pp. 300-305.
- [58] Pfeifer, W., Helpelmann, W. and Dirks, F. (1989), "Treatment of Low and Medium-Level Residues and Wastes from Reprocessing", *Kerntechnik* 54, No. 4, pp. 258-262.
- [59] Heafield, H. and Gairhall, G. (1987), "The Conditioning and Storage of Intermediate Level Wastes in the UK", RECOD-87, Vol. 2, pp. 705-714.
- [60] Chrubasik, A., Kemmler, G. and Scherbaum, L. (1987), "Process for the Treatment of Spent TBP Kerosene (PUREX) Solvents", RECOD-87, Vol. 2, p. 773.
- [61] Sakuramoto, N. *et al.* (1991), "Treatment by Pyrolysis of Solvent Waste", RECOD-91, Vol. 1, pp. 422-426.
- [62] Ichihashi, T. *et al.* (1987), "Oxidative Decomposition of Spent Organic Solvents from Reprocessing Plants", RECOD-87, Vol. 2, p. 773.
- [63] Nishimura, K., Nakabayashi, S. and Tanaka, H. (1987), "Solidification of Spent TBP Solvent with Aluminium Chloride Compounds", RECOD-87, Vol. 2, p. 781.
- [64] Guillaume, B., Germain, M., Puyon, M. and Rouyer, H. (1987), « Gestion du Solvant dans une Usine de Traitement de Grande Capacité », RECOD-87, Vol. 1, p. 443.

- [65] Moulin, J.P. *et al.* (1998), "MDS: Mineralization Solvent Process", RECOD-98, Nice, Vol. 2, pp. 505-509.
- [66] Maeda, M. *et al.* (1987), "Tritium Scrubbing of Organic Product Stream from Co-Decontamination Step for Tritiated Water Recycle Process", RECOD-87, Vol. 2, pp. 511-515.
- [67] Bruggeman, A. *et al.* (1986), "Development of the ELEX Process for Tritium Separation at Reprocessing Plants", ENC-4-FORATOM IX, Vol. 4, pp. 171-178.
- [68] IAEA (1984), "Management of Tritium at Nuclear Facilities", IAEA-TECDOC-234, Vienna.
- [69] Proceedings 3rd Topical Meeting on Tritium Technology (1988) in *Fission, Fusion and Isotopic Application, Fusion Technology*, Vol. 14, No. 2, September.
- [70] Bleyer, A. *et al.* (1987), "Carbon-14 Inventories and Behaviour in LWR Spent Fuel Rods During Reprocessing", RECOD-87, Vol. 3, pp. 1089-1094.
- [71] Luyckk, F. (1986), "Gaseous Effluent Treatment", Proceedings European Conference Luxembourg, edited by G. Fraser, EUR 10580, pp. 333-393.
- [72] Weirich, F. (1989), "Krypton Removal of the Dissolver Off-Gas with the Solvent R12", *Safety of the Nuclear Fuel Cycle*, edited by K. Ebert and R. von Ammon, pp. 189-200.
- [73] UNSCEAR (1986), "Ionizing Radiation Sources and Biological Effects".
- [74] CEC (1981a), "Management Modes for Iodine-129", edited by W. Hebel and G. Cottone, Proceedings CEC meeting, Brussels, Commission of the European Communities.
- [75] CEC (1981b), "Iodine Removal from Gaseous Effluents in the Nuclear Industry", Proceedings Conference, V/5283/82, Commission of the European Communities, September 1981, Mol, Belgium.
- [76] Bernard, C. *et al.* (1991), "Advanced PUREX Process for the New Reprocessing Plants in France and Japan", RECOD-91, Vol. 1, pp. 83-88.
- [77] Herrmann, B. *et al.* (1994), "¹³¹Iodine in the Off-Gas of Karlsruhe Reprocessing Plant (WAK)", RECOD-94, 1, Session Dissolver Off-Gas Treatment and Iodine Retention, Londres.

Chapter 9

SAFETY OF ON-SITE WASTE STORAGE

1. Vitrified waste

1.1 Technology and experience acquired

Vitrified waste must be stored during the period between solidification and their disposal. This period can last up to several decades, mainly to enable the level of activity and the production of heat to decrease to suitable levels for disposal.

Several concepts have been developed for this interim storage, as described in the IAEA report [1]. They are air-cooled vaults, pools, and shielded sealed casks. In all three cases, the waste is conditioned in standard stainless steel containers. In the case of dry storage vaults, cooling can be by natural convection or forced circulation of air. In principle, natural convection is to be preferred because of its mechanical simplicity and its reliability. However, if the construction and size of the vault render natural convection difficult, or if extraction filters are to be used, then forced ventilation would have to be used.

Essentially, the choice between dry storage vaults and pools depends on the total heat extraction capacity and the thermal power of each HLW canister. Insofar as the cooling time between the unloading of the spent fuel and the vitrification of HLLW has steadily increased, air-cooled vaults are preferred; they are currently in operation notably in France, the United Kingdom, Japan, Belgium, and the Netherlands (Figure 9.1).

Figure 9.1. Vitrified waste interim storage room (Source: COGEMA – France)



The technique of shielded, sealed casks is intrinsically safe and only requires a minimum of monitoring as the heat generated by decay is dissipated by natural convection. It is used in Germany for vitrified waste.

1.2 Safety considerations

By definition, HLW generates heat. Vitrified waste typically has a heat output of the order of 10 to 20 kW/m³ of vitrified product. (This is only an approximate figure as heat output is dependent on the concentration of fission products in the waste, the initial fuel cooling time and the time taken for the various reprocessing stages through to vitrification). Reliable, continuous cooling is then important for the safe storage of vitrified waste, as it is for the storage of spent fuel and HLLW, but loss of cooling would have less serious consequences for vitrified waste because:

- the cooling time is longer;
- the waste is in a solid form which is chemically and thermally inert and thermally stable;
- the storage system displays considerable thermal inertia which enables natural convection to constitute the main mode of heat dissipation after prolonged loss of forced cooling, if any;
- the proportion of volatile products, notably certain fission products, is very low, as a direct consequence of the process used to solidify the waste.

The main consequences of failing to dissipate this heat would be:

- accelerated degradation of the structural materials used for shafts and extractor ducts when exposed to overheated air;
- a rise in temperature of the vitrified mass with the attendant potential for degradation as the kinetic mechanisms that can induce devitrification become significant at temperatures over 650°C.

The first point is not a short-term concern (there would be plenty of time to take mitigating measures), and the second point is a safety issue only for the geological disposal, not for the storage facility. The effect of devitrification is to increase the leach rate of fission products from the glass matrix in a process that will occur at best thousands of years after storing vitrified waste in a geological formation. Moreover, if such devitrification happened, it would be possible to anneal the glass by heating it – a probably costly operation, but possible.

Nevertheless, much attention is given to cooling systems reliability, particularly during the initial phase of operation when heat generation is at its highest.

As previously stated (Section 2-2.8.1 above), the storage building is systematically designed so that natural convection alone is sufficient to remove the heat output of waste, as well for direct cooling as for indirect cooling facilities. This ensures that operating temperatures will not be exceeded. However, it is common practice to install exhaust fans to provide forced draft ventilation in view of the advantages afforded by the additional investment:

- it may be difficult to remove heat during the initial phase of operation. Once the heat load has decreased sufficiently, the fans can be shut down in order to reduce operating costs;
- lower exhaust duct temperatures prolong the life of structural materials;

- fans can replace natural convection when the latter is precluded by adverse weather conditions;
- in direct cooling systems, exhaust air is generally passed through filters before being discharged via the stack (often a regulatory requirement for these systems). The filters will be by-passed in case of temporary forced ventilation shutdown, requiring a radiological monitoring of exhaust cooling air.

As stated above, a great deal of experience has been acquired in the field of air-cooled storage. In France, in first generation direct cooled facilities air-cooling is initially obtained by forced circulation of air and natural convection is used at a later stage. Indirectly cooled second generation facilities rely entirely on natural convection. The United Kingdom installation relies on natural convection from the outset, but ventilators are installed as a back-up, to deal with any significant reduction in natural convection caused by phenomena such as unfavourable weather conditions, or with the introduction of regulations requiring the addition of extraction filters. The maximum glass temperature is generally maintained below 600°C and the outlet temperature of the air is between 85 and 150°C depending on process characteristics. Insulation generally keeps temperature of structural materials below 60°C. Given temperatures of this order, the stability of the concrete or other structural materials can be ensured for the whole life of the store.

The second safety consideration relates to the possibility of a container being dropped as it is loaded into or unloaded from the shaft, following a handling system failure or operating error.

To reduce the consequences of this type of incident, shock absorbers are installed at the foot of each storage shaft. These are designed to absorb the impact energy and to prevent a loss of container integrity. In the event of such an incident, the container(s) must be removed from the shaft for inspection, repair and, if necessary, reconditioning.

Other safety issues, such as earthquakes, flooding, accidental plane crashes, etc., must be taken into account in the design. Their probabilities depend on the site. As these hazards are not specific to HLW, they are not addressed in this Section, but given the experience acquired in taking these constraints into account for the design of recent nuclear reactors and reprocessing plants, the design of vitrified waste stores should not present any difficulty.

The principal hazards to the operators reside in operations of filling or emptying the installation, connected with the handling (risk of dropping) of high radiation objects (risk of exposure) in the event of failure of the equipment or its control systems.

Regarding off-site impact, checks to ensure that the outer surfaces of the containers are not contaminated prior to storage, measures designed to ensure their integrity while in storage, either the containment of indirect cooling or the widespread practice of filtering cooling air with HEPA filters before venting it and radiation monitoring, all ensure that the quantities of radionuclides discharged to the environment are extremely low or nil.

The only secondary wastes generated by storage are either liquid effluent from container decontamination, where there is any, or extraction filters contaminated under abnormal conditions in directly cooled facilities.

2. Cladding waste

2.1 Introduction

Besides HLLW, waste streams include certain structural elements of fuel elements and solid residues. These wastes generally produce less decay heat than the vitrified waste mentioned in Section 9-1, and, in general, loss of cooling therefore presents no major safety problem. The characteristic shared by these wastes is their high level of radiation, caused mainly by products of activation, especially in the form of beta and gamma radiation. Contamination by actinides (from adhering undissolved fuel) may reach 1% in certain cases, which may increase levels of radiation (Modern plants have a much better record than this upper limit). The most important conditions to respect consist of installing adequate radiation protection shields and using remote handling techniques.

2.2 Magnox cladding swarf

Magnox cladding swarf can be pyrophoric in certain conditions [2]; it can also react with water to produce hydrogen. This reaction may accelerate to reach a point where it may lead to a dangerous instantaneous production of hydrogen.

The system chosen for Magnox swarf from the first nuclear programs, notably in the United Kingdom, was dry storage in concrete silos. Though no pyrophoric incident has been recorded in these silos, the dry storage silos in Sellafield, which date from the 1950s, have later been equipped with a rapid response argon inerting system, enabling the fire prevention system to be modernised.

A fire was recorded in a dry storage silo in the UP2-400 plant in La Hague in France. Two silos, each of a volume of 2 500 m³, had been installed for storing the graphite sleeves and magnesium end-pieces from GCR fuel elements. Slow combustion of part of the contents of one of the silos was detected by radiological monitoring. Nitrogen flushing, followed by the injection of large quantities of water, enabled the situation to be kept under control. The presence of fragments of uranium, combined with mechanical shocks during the last unloading of waste into the silo, is considered to be the possible cause of the fire. Subsequent to this incident, the equipment and the building have been refurbished and new precautionary measures have been taken to prevent a similar event from occurring in the future.

Most Magnox swarf from historic reprocessing operation, however, is stored under water in concrete silos. In principle, the production of hydrogen is slow, but the reaction also produces heat, and if heat transfer toward the outside of the silo is low it may generate a runaway thermal reaction with instantaneous production and release of hydrogen. The heat produced may result in structural damage to the concrete silo, and the concentration of hydrogen above the water level can reach 40 to 50% (within the detonation range). Cooling coils are often built into the silos, but the fragments themselves may limit convection phenomena, thus restricting cooling and possibly resulting in such an excursion. Many of the earliest underwater storage silos probably do not contain any more Magnox swarf, most of which has reacted with the water to form dense sludges. The silos are ventilated to prevent the build up of hydrogen. The more recent silos are equipped with argon or nitrogen inerting systems, activated by temperature or hydrogen sensors in the silos, which are intended to maintain the hydrogen concentration below the flammability limit in the event of an excursion.

Given the problems inherent in the dry or underwater storage of Magnox swarf in bulk in silos, this form of storage can best be seen as an intermediate stage while awaiting encapsulation or immobilisation of the swarf prior to disposal (see Section 8-4).

Newly arising Magnox swarf is encapsulated as soon as it is processed into a concrete matrix into stainless steel drums suitable for long term storage. Such waste is then held in ventilated and shielded stores.

2.3 *Stainless steel waste*

This waste may include stainless steel hulls from oxide-based fuel (FBR or first generation LWR fuel) or structural elements (end-pieces, grids, spacers, etc.) from fuel assemblies. It presents very few problems, apart from high levels of radiation, and is generally stored in silos. They are sometimes stored together with Zircaloy hulls, in which case the safety considerations concern the latter rather than the former. In any case, that is only an interim storage technique, and in France the steel components have been encapsulated in concrete with the Zircaloy hulls, with a view to disposal. Research and development work has been carried out in France into reducing the volume of hulls and end-pieces by melting or compaction [3]; only the latter process has been chosen for the La Hague plants, as described below.

2.4 *Zircaloy hulls and end-pieces*

In the UP2-400 plant in La Hague, end-pieces and Zircaloy hulls resulting from the shearing and dissolution of LWR fuel were transferred in bulk under water into a silo up until 1989. These hulls and end-pieces were transferred from the shearing cell to the silo in a hydraulically driven drum through a sloping pipe that ended in a cell above the silo. The drum was emptied into this cell and sent back to the shearing cell. The inside lining of the silo is in stainless steel. The pH of the water is maintained at a value of about 4. The silo plenum is continuously vented.

Although the operation of this silo had presented no safety problems, the French Nuclear Safety Authority requested that COGEMA plan more easily retrievable storage installations and prepare for the emptying of the silo. New organised storage was installed in the pools of the former GCR fuel decanning facility. Hulls and end-pieces are placed in separate drums. The drums are transferred from the shearing cell to the pool by a cask and stored under water. The pool water is subjected to the same treatment as fuel storage pools. Its level of activity is limited in operation to 185 MBq/m³.

In the UP3-A and UP2-800 plants, the hulls and end-pieces have been during a first period cemented in drums, around one drum per 2 tHM. Around 1 500 drums have been produced. In the second period, the hulls and end pieces are compacted and the resulting disks are placed into containers identical to vitrified waste containers. This operation takes place in the ACC facility described in Section 8-1. The hulls and end-pieces from UP2-400 stored in the silo and the organised storage will be also compacted in ACC.

The containers of hulls and end-pieces (either cemented or compacted) are transported in a cask by internal site road transport to be stored in a shielded and ventilated building (EDS or ECC respectively) in which they are handled by remote control.

2.5 Graphite waste

The head-end process applied to AGR fuel in the United Kingdom produces a waste stream of radioactive graphite resulting from the extraction and crushing of the sleeves of each fuel assembly. At present this is stored in steel containers in air-cooled storage facilities (of similar design to vitrified waste storage facilities). When it initially comes out of the process this waste is wet, and the release of hydrogen through radiolysis necessitates filtered venting of the steel containers. This waste is destined for future containerisation and disposal.

Similar waste exists in France, resulting from the operation of GCR. It is stored in silos, either on reactor site or on the site of the reprocessing plants, awaiting evacuation.

3. Insoluble residues

Dissolution fines consist mainly of insoluble noble metals, ruthenium, rhodium, palladium, and molybdenum together with Zircaloy or stainless steel fines produced during fuel shearing operations (see also Section 8-4). The typical quantity produced is 3 to 5 kg/tHM. These fines release a quantity of heat of about 300 W/kg, generated mainly by short-lived fission products (^{103}Ru and ^{106}Rh), and may contain small quantities of undissolved uranium and plutonium. They are recovered either at the bottom of the dissolver or in the clarification equipment down-line (centrifugal decanter or filter).

Safety can be improved by conserving these residues in a less dispersible form. Work carried out over the beginning of 90s has demonstrated that these residues can be incorporated into vitrified waste, the solution adopted in France and Japan. In the United Kingdom the residues and fines may be encapsulated in concrete after suitable cooling.

In the UP2-400 plant, the dissolution fines are stored in the silo of hulls and end-pieces. In the UP3-A and UP2-800 plants the dissolution fines are vitrified with the HLLW. Before this solidification, they are stored under water in tanks very similar to those used for HLLW. These tanks are equipped with reliable stirring and cooling systems to prevent accumulation or dehydration of the fines.

4. References

- [1] IAEA (1983), "Handling and Storage of Conditioned High Level Wastes", IAEA-TECDOC-229, Vienna.
- [2] Lefort, G. (1983), "Potential Fire or Explosion Risks in Reprocessing Plants", Proceedings CSNI Specialists Meeting, Los Alamos, LA-9911.C, Los Alamos National Laboratory, Los Alamos, NM, pp. 41-55.
- [3] Jouan, A. *et al.* (1987), *International Conference on Nuclear Fuel Reprocessing and Waste Management*, RECOD-87, Paris, pp. 723-730.

Chapter 10

SAFETY OF DECOMMISSIONING OF NUCLEAR FACILITIES

1. Decommissioning strategy

Decommissioning is the final stage in the life-cycle of a nuclear facility. The final act of shutting down the facility should be to remove the radioactive materials in process and the radioactive waste from normal operations. Subsequently, during decommissioning, the remaining radioactivity must be safely removed from the facility through decontamination and dismantling, so that the facility can be demolished, or refurbished for re-use. If the radioactive materials and waste are not so removed, that becomes the first act of decommissioning. In general, POCO (post operational clean out) is assumed to be part of the shutdown process. Proper planning and implementation of decommissioning provides for protection of the health of workers and the public and of the environment.

The first key decision is to select the decommissioning strategy. Among other things, this decision will define the timing and the sequencing of the decommissioning activities. The selected option should be justified by developing a decommissioning plan (see Section 10-2) in compliance with the safety requirements specified by the regulatory body. There are three primary decommissioning options that should be considered when planning a fuel cycle decommissioning project: immediate dismantling, deferred dismantling, and entombment [1]. Other options that may be considered are combinations or variations of these options. The specific characteristics of each type of nuclear fuel cycle facility will strongly influence the selection of the decommissioning option. Furthermore, non-safety related considerations are also important in the option selection process (e.g. recycling material as opposed to disposal). It is also necessary to balance the safety requirements with the resources available for carrying out decommissioning.

In most cases, entombment is not a reasonable option for the decommissioning of nuclear fuel cycle facilities that are contaminated with long lived alpha radionuclides. Entombment implies that a majority of these radionuclides will be permanently contained in an engineered structure near the surface. It has been recommended that waste which contains significant amounts of these radionuclides should not be disposed of near surface facilities [2]. The entombment option is not considered further in this case.

Paragraph 3.3 of IAEA Draft Safety Guide [1] lists the issues that should be included in the evaluation of the various decommissioning options. Cost-benefit or multi-attribute type analysis provides a systematic means for such evaluations. Based on experience (see the Introduction to [3]), the factors which are judged to be particularly important in deciding on the decommissioning strategy are:

- radioactive inventory and its mobility and decay characteristics (e.g. half-life of the dominating radioactive nuclides);
- availability of proven techniques and equipment to perform the specific dismantling tasks;

- possibilities for treatment (including volume reduction) and storage or disposal of the waste arising from dismantling;
- extent of surveillance and maintenance measures required during dormancy periods when dismantling is deferred (i.e. during safe enclosure);
- intended re-use of the premises or site;
- other factors influencing the cost, such as the assumed discount rate (basically the expected interest rate minus the expected inflation rate for dismantling costs, which are deferred);
- political and social considerations (e.g. employment of plant operating staff on immediate dismantling).

The decommissioning strategy in the United Kingdom is set out in a government white paper [4], see particularly §124, 125, and 127. The disposal of waste arising during decommissioning is subject to regulation under RPA 93 [5].

The United Kingdom regulator HSE/NII has provided guidance on decommissioning for their inspectors [6]. In paragraph 6.1 of that guide, they set out the NII’s regulatory strategy to ensure safety in the decommissioning of nuclear facilities. This strategy encapsulates the United Kingdom Government Policy [4]. NII has four fundamental expectations for decommissioning that should be met so far as is reasonably practicable. These expectations are:

- in general, decommissioning should be carried out as soon as it is reasonably practicable, taking account of all relevant factors;
- hazards associated with the plant or site should be reduced in a progressive and systematic manner;
- full use should be made of existing routes for the disposal of radioactive waste;
- remaining radioactive material and radioactive waste should be put into a passively safe state for interim storage pending future disposal or other long-term solution.

The NII also “requires operators to undertake strategic planning for decommissioning including the future management and disposal of all the radioactive waste which may result” (see [6, §6.4]). Further guidance on decommissioning strategies is given in Appendix 2 of this reference.

1.1 Government policies

UK Government Policy requires HSE/NII in consultation with the environment agencies to carry out quinquennial reviews of operators’ decommissioning strategies. Further information of such reviews is given in Appendix 7 of [6]. Reference [7] gives a helpful list of HSE/NII expectations for decommissioning activities. They also recognise that the requirements for decommissioning have to be considered in the context of the non-availability of disposal routes for some decommissioning wastes in the United Kingdom. Nonetheless, the HSE/NII require the radioactive waste from decommissioning to be segregated and characterised to facilitate the overall safe management of conditioning, storage, retrieval, and subsequent disposal. Further guidance on United Kingdom regulatory requirements for the management of radioactive materials and radioactive wastes, including waste minimisation, characterisation, and segregation, and passively safe state storage are given in [8].

The US NRC's practice for decommissioning non-reactor facilities is outlined in [9]. The national policy and regulations (together with research and development programmes) for decommissioning in Japan are reported in [10].

The IAEA publishes helpful information on strategic and technical aspects of decommissioning in Technical Reports. A number of these reports are listed in [11,12,13]. These reports are based on international consensus. They mainly focus on consolidated experience and lessons learned. A list of Technical Documents (TECDOCs) is also provided in [11]. TECDOCs typically contain preliminary information or cover areas where international consensus is lacking.

1.2 Timing

A number of factors which influence the timing of decommissioning have necessarily been indicated in the general requirements for deciding on a decommissioning strategy. In broad terms, the choice is between immediate and delayed decommissioning. As Hammer [14] concludes based on experience in decommissioning French nuclear facilities:

Immediate dismantling is justified if the safety conditions of the shutdown installation require it, or the radioactivity level remains constant over time. Deferred dismantling is justified if a significant reduction in radioactivity is expected over time. With the exception of possible safety problems, deferred dismantling may be chosen for installations containing mainly short lived activation products, whereas contaminated installations and those containing long-lived radio elements will require immediate dismantling.

Gamberini [15] reports that experience in decommissioning a reprocessing pilot plant at Sellafield showed that "extended deferral of decommissioning leads to significant data collection problems, for example, lack of plant/operational data and loss of experienced personnel who operated the plant". Pomfret, *et al.* [16] also discuss the potential benefits and drawbacks of deferring the decommissioning of nuclear facilities based on experience in BNFL.

Deferral of decommissioning activities may not significantly reduce the activity of the remaining radionuclides, the quantities of radioactive waste produced, or the radiological exposure to site personnel. This is due to the relatively long half-lives of the involved radionuclides, and, in some cases, the potential for isotopic in-growth (for example, ²⁴¹Am). Deferred dismantling also tends to increase the cost of maintenance, surveillance, and physical protection of the nuclear facility. Moreover, extended delays to decommissioning activities can result in the gradual deterioration of structures, systems, and components designed to act as barriers between the radionuclide inventory and the environment. This deterioration may also apply to systems that could be used during facility dismantling [1, §3.6]. In the United Kingdom, in line with Government Policy, HSE/NII requires operators to decommission their nuclear facilities as soon as is reasonably practicable, taking account of all relevant factors. Operators should justify the timing of decommissioning that is part of their strategy, through discussion and quantification of these factors [6, §6.7]. Further helpful information on NII's expectations of, and factors affecting the timing of, decommissioning are given in Appendix 4 of this reference.

2. Decommissioning planning

Successful, safe decommissioning depends on careful and organised planning. "A decommissioning plan should be prepared for each facility" [17, §6.2]. The extent of the plan, the

content, and degree of detail depends on the complexity and hazard potential of the nuclear facility and should be consistent with national regulations. An integral part of such a plan is a safety assessment (see Section 10-4).

Operators “shall plan for adequate financial resources to ensure the decommissioning of a facility” [17, §3.17]. United Kingdom regulatory guidance on costs of radioactive waste management and decommissioning is given in Appendix 6 of [6]. The CEC has supported the development of an ORACLE database, containing accumulated experience of costs (and radiation exposure) for individual decommissioning steps [18].

The IAEA [1] envisions three stages of planning as:

- initial: outlines the overall decommissioning process and should be submitted by the operator to the regulator in support of commissioning/operation;
- ongoing: reviews and updates the initial plan periodically during operation;
- final: gives the finalised, detailed proposals for decommissioning that are submitted to the regulator for review and approval.

For a given facility, the degree of detail increases from the initial to the final plan. Guidance on items to be included in the final decommissioning plan is given in [1, §5.12].

Colquhoun [19] reports that to reach optimal solutions to the broad requirements of safe decommissioning, BNFL have developed:

- extensive front end design and optioneering studies;
- structuring of large projects into phases, each of which on completion progressively eliminates technical and costs uncertainties;
- a computer-based universal spreadsheet approach to cost estimation (as described in [20]);
- a computer programme to calculate sources of radiation from measured dose rates and a knowledge of plant geometry (as described in [21]);
- compilations of a series of computerised databases and advisory systems for decontamination techniques, remote handling systems, size reduction tooling, glove box decontamination strategies and decommissioning unit costs, and dose uptake data for unit operations;
- the practice of avoiding high cost, project-specific, technical approaches. The aim is to gain an acceptable and cost effective mix of men and machines.

3. Decommissioning management

To ensure safety during decommissioning, the decommissioning organisational structure needs to reflect the change of activities from operation to decommissioning (see Table 10.1). Ideally a team of decommissioning specialists and appropriate site personnel should be formed to manage the decommissioning project. In the United Kingdom, HSE/NII requires the operator to maintain an “appropriate” organisation and “to manage the organisational change throughout decommissioning to ensure safety” [6, §6.9].

Table 10.1. Differences between decommissioning and operational states

Decommissioning	Operations
Temporary design life of structures to assist dismantling	Permanent design of structures for operation
Safety management systems based on decommissioning tasks	Safety management systems on operating nuclear facility
Control based on as-built structures	Control based on drawings
Reduced safety risks but changing situation	Significant safety risks but permanent and routine
Management of changing situation during decommissioning	Management of steady state during operation
Reduced administrative infrastructure	Steady state administration infrastructure
Retraining staff for new activities	Routine training and refreshment training
Visible end of employment – refocus their work objective	Permanent employment with routine objectives
New or developing regulations/regulatory requirements	Established and developed regulations for operation

The organisational structure needs to be defined, authorities and responsibilities delineated, communication routes established, and training programmes implemented. The safety management system must:

- ensure a systematic and progressive reduction of the hazards presented by the nuclear facility or site [6, §6.3];
- ensure that all equipment necessary for safety is periodically monitored and maintained during decommissioning, including any surveillance and maintenance periods;
- establish an independent radiation protection organisation;
- ensure that the waste management plan, which is part of the decommissioning plan, is implemented;
- ensure procedures are in place to deal with unforeseen events (emergency preparedness);
- implement an appropriate quality assurance programme [6, §6.11];
- implement appropriate administrative control measures.

Guidance on United Kingdom regulatory requirements for decommissioning management is given in [6] at Appendix 5.

In the United Kingdom, operators often make increased use of contractors during decommissioning as compared with operations. The United Kingdom regulatory regime requires that the operator bear sole and absolute authority for nuclear safety. This responsibility cannot be delegated to another party [22]. This increased use of contractors and the longer term partnering/alliance arrangements between operators and experienced decommissioning contractors has prompted HSE/NII to explain its position (see [23,24]). Essentially, this has meant defining the attributes a nuclear operator needs in terms of staffing, organisation, and methods to control contractors.

4. General requirements of safe decommissioning

“During all phases of decommissioning, workers, public and the environment shall be protected from both radiological and non-radiological hazards resulting from decommissioning activities” [17, §2.1]. A survey of the inventory and location of radioactive and other hazardous materials is a necessary precursor of safe decommissioning work (see Section 10-5.1, Characterisation) and is an important input to the safety assessment.

The specific safety issues that need to be considered in the decommissioning of nuclear fuel cycle facilities include [1]:

- the presence of all types of radioactive contamination, in particular, alpha contamination;
- high radiation levels in some facilities (requiring consideration of remote handling);
- the increased hazards associated with the possible in-growth of radionuclides (i.e. ^{241}Am);
- the potential for criticality hazards in some facilities associated with possible accumulation of fissile material during decontamination or dismantling activities;
- the complex waste management strategies due to the diversity of waste streams;
- the hazards associated with the original processing activities (e.g. fire, explosion, toxic chemicals);
- the hazards associated with decommissioning operations such as decontamination, cutting, and handling of large components and the progressive dismantling or removal of some existing safety systems.

As decommissioning activities have become more frequent, more and more countries have developed national regulations and specific guidance. Such requirements set a framework for demonstrating safety during decommissioning.

4.1 Safety assessment and safety cases

The safety assessment, which forms part of the decommissioning plan, “shall be commensurate with the complexity and hazards associated with the facility or operation” [17, §7.4]. Non-radiological as well as radiological hazards involved in decommissioning activities have to be identified and evaluated in the safety assessment [1].

In the United Kingdom, safety assessments are part of the decommissioning safety cases that the HSE/NII requires operators to prepare. Where appropriate, NII assesses these safety cases [6, §6.6]. Further information on such safety cases is given in Appendix 3 of this reference.

Robinson [25] gives a full description of what the United Kingdom regulator requires. He points out that a key requirement of ALARP in relation to decommissioning is for operators to show that the option they wish to follow is based on a broad knowledge of the options which are feasible. In considering which option should be followed, the factors considered should include good engineering practice, deterministic criteria, and probabilistic criteria. Great weight should be given to good engineering practice, which should take account of national and international standards. The totality of decommissioning should be considered at the outset, i.e. both short-term aspects and longer term issues, including:

- the radioactive inventory and the degree to which it is mobile;

- handling waste and their disposal;
- safety issues connected with surveillance and maintenance;
- availability of staff with experience of constructing or operating the facility;
- the arrangements to capture and preserve information;
- the possible need to upgrade services and containment;
- site remediation;
- social and economic factors, etc.

Herbert, *et al.* [26] review their experience of developing safety cases for major decommissioning projects at Sellafield. They describe an approach to safety documentation which results in robust and yet flexible safety cases. This gives a cost-effective system in terms of the safety cases themselves and in consequent benefits during decommissioning.

The techniques they use in producing safety cases include:

- value engineering or option studies to identify the most appropriate decommissioning options;
- HAZOP studies to identify hazards, operability problems, etc.;
- radiological and criticality assessments to assess risks and define the safe working envelope;
- dose and ALARP assessments based on health physics surveys to demonstrate that operator doses are optimised;
- decommissioning project reports to provide valuable feedback into future safety cases.

Based on decommissioning experience in the United Kingdom, Williams [27] reinforces the need for risk assessments to be undertaken at an early stage and then used throughout the decommissioning programme.

In the United Kingdom, the concept of independent peer review is a vital part of the safety documentation approval process. A suitable and well recognised expert (the peer reviewer) is selected to produce an independent assessment of the acceptability of the safety arguments. Peer review of decommissioning safety assessments is discussed by Francis [28].

The use of criticality safety assessments in support of decommissioning at Sellafield have been reported in [29] and in [30]; and the criticality issues associated with the processing and disposal of decommissioning waste have been reported in [31]. A criticality assessment of initial operations at the defence waste processing facility at Savannah River is reported in [32]. For further information on criticality, see Section 4-2.

4.2 Radiological protection and ALARA

In the Summary of the proceedings to a workshop on ALARA and decommissioning [33], it is concluded that optimisation of radiological protection has been shown to be a routine feature during major decommissioning operations in the nuclear industry. Nonetheless, a number of outstanding issues are identified. These include:

- the need to develop tools to estimate dose rates in complex and evolving environments and activity levels of large amounts of waste;

- the need to develop techniques, models, and software to realistically predict and follow up internal exposures;
- the need for a total risk approach which is transparent.

Argonne National Laboratory has developed a series of computer codes for evaluating the radiological dose and risk incurred during decontamination and restoration of nuclear facilities. This series of codes, known as the RESRAD family of codes, are discussed by Yu [34]. RESRAD codes are used in the United States and a number of European countries.

The use of ALARA/P during a major refurbishment of a reprocessing plant in the United Kingdom [35] and the decommissioning of a uranium mill in Spain [36], as well as a method of dose control in decommissioning operations at Sellafield [37], have been described; together with regulatory experience of ALARP and decommissioning at United Kingdom nuclear sites [38] Robinson concludes that operators have been successfully applying the ALARP principle to decommissioning and in many respects already operate in line with ICRP 60 [39].

5. Decommissioning technology

It is not the intention of this Section to detail the multitude of techniques available, and under development, for accomplishing decommissioning. The aim is to characterise safe nuclear fuel cycle decommissioning and summarise the current situation. Thereafter, more information is provided on the requirements for, and the current status of, the critical tasks for safe decommissioning (i.e. characterisation, decontamination, dismantling/demolition, and site restoration). Here POCO is assumed to be the final act of operation.

In the United Kingdom, decommissioning is subject to the same licensing regime as that applied during the preceding operation phase [6, §6.3]. However, as Laraia [12] has pointed out, there are significant differences between decommissioning and operational states, see Table 10.1.

Fuel cycle facilities, as compared to power reactors, have a number of important and unique features which must be taken into account during decommissioning [40], including:

- distinct modules that can be isolated and decommissioned as individual work sites;
- a greater variety of risks to be managed during decommissioning because of the diversity of past operations (i.e. mechanical, chemical, treatment of powders) and the variety of materials processed;
- the variations in the levels and localisation of activity levels in and on process equipment, pipes, walls, etc.

Based on the CEC's technological programmes on the decommissioning of nuclear fuel cycle facilities, Pflugrad [41] concludes that:

- nuclear facilities such as reprocessing plants, shut down correctly after a normal operating life, can be dismantled with currently available technology;
- doses to workers are generally lower during decommissioning than during the operating phase, as highly active components are remotely segmented and handled;
- the risk to the general population by recycling metallic waste materials with trace activity is very low and can be controlled effectively;
- waste arising will differ between types of plants, but melting, decontamination, recycling, and segregation of wastes can reduce the final volume considerably;

- at present, it generally takes longer to dismantle a nuclear plant than it takes to build it. This is due to the severe precautions applied to protect the workforce and the environment;
- though the main results are on the whole quite positive, there is still a need to make decommissioning work safer and more cost effective, for example by:
 - making the scientific and technical information and experience rapidly and clearly available to those dealing with decommissioning;
 - continuing to collect decommissioning experience in suitable and powerful data bases;
 - reinforcing international co-operation, mainly between the European Union (EU), IAEA, and OECD/NEA;
 - co-ordinating on the EU level a decommissioning network for the future exchange of results and experience, particularly from ongoing decommissioning projects, as well as the (continuing) establishment of decommissioning guidelines and strategic planning tools.

5.1 Characterisation

A survey of radiological and non-radiological hazards must be conducted to identify the inventory and location of radioactive and other hazardous materials. In planning and implementing surveys, existing records and operating experience should be utilised. An adequate number of radiation and contamination surveys must be conducted to determine the radionuclides, maximum and average dose rates, and contamination levels throughout the facility [1, §6.1, 6.2].

An inventory of all hazardous chemicals present in the facility should be made. Hazardous materials such as asbestos, mercury, and PCB require special consideration to prevent harm to human health and damage to the environment. Consideration must also be given to the compatibility of the chemicals which are present or may be added during decommissioning. For facilities that have been inoperable for a long period of time before decommissioning begins, a survey of equipment should be made to assess structure and system deterioration hazards [1, §6.3].

Regarding criticality safety, special attention is needed during characterisation of any fissile material that may be left in the plant [1, §6.4].

5.2 Decontamination

Decontamination is an important stage in the decommissioning process because it not only reduces radiation during decommissioning operations, but also has the potential for the reclassification of wastes to achieve lower disposal costs. The key factor in decontamination is to minimise the total detriment in terms of operator dose uptake, risks to the public and waste disposal. Consequently, it is pointless to reduce the activity levels of some components to ease waste disposal if the decontamination operation generates even larger volumes of active waste. The objectives of decontamination are listed in [1, §6.7], and a means of evaluating its effectiveness is listed at §6.8.

The approach to decontamination depends on the type of contamination [42]. Contamination can be classified into:

- free contamination, which can be removed by simple blowing, vacuum, or similar methods;
- loose contamination, which can be removed by common cleaning techniques;
- fixed contamination, which cannot be removed without the removal of the surface layers.

Decontamination is the opposite of contamination. It does not eliminate radioactivity, but just removes it to a different place. Most of the development work on decontamination is, not unexpectedly, on fixed contamination.

Gamberini [15] reports how effective cleaning of lead shielding sheets and blocks (using Pentek 603 self strip coating, or in more onerous situations, an aerosol of 4M nitric acid) has reduced the contamination to levels that allow it to be re-used on the Sellafield site.

A bio-decontamination technology which harnesses the action of naturally occurring bacteria to decontaminate massive concrete structures is being developed by BNFL and INEEL. This emerging technology could have advantages of cost, worker health, and safety risk reduction [43].

Different policy options for the recycling of contaminated scrap metal arising from the dismantling of nuclear installations have been set out by the CEC [44]. It concludes that the recycling of slightly contaminated scrap metal from dismantling nuclear installations is rather a matter of public acceptance than cost-benefit analysis.

The recycling of metal scrap from nuclear installations has also been discussed by Menon [45] around an NEA report [46] on recycling and re-use of scrap metal from nuclear decommissioning. The application of the exemption principle to the recycle and re-use of materials from nuclear facilities has been described by IAEA [47], based on [48].

Although directed primarily at decontaminating nuclear reactors, [42] in Chapter III (1995), provides a wealth of background information on the decontamination process, including the pros and cons of a wide variety of techniques used in a range of situations, supported by almost 150 references.

5.3 *Dismantling and demolition*

Dismantling means all the physical operations performed to eliminate the nuclear part of a facility. Unlike classic industrial facilities, nuclear dismantling specifically takes into account the time factor to take advantage of natural radioactivity decay [49].

There are many available options for safe dismantling and their selection depends on the types and characteristics (e.g. size, shape, and accessibility) of equipment and structures to be dismantled. Factors for consideration are listed in [1, §6.10]. In many cases, decontamination and dismantling activities are aimed at making the demolition of the building structure a non-radiological activity. Where demolition of structures involves radioactively contaminated material, the safety considerations for dismantling should be applied to the demolition [1, §6.14]

The dismantling of a nuclear installation requires the cutting and segmentation of equipment and structures of varying sizes and dimensions, and consisting of metal, concrete, stonework, or plastic materials. In view of the wide range of dismantling tasks, many different cutting techniques have been developed ([42], Chapter IV). In some cases, techniques already used in the sheet metal manufacturing industry have been adapted to the special requirements of nuclear dismantling. In addition, special techniques have also been developed exclusively for such tasks.

Further information on the techniques available (thermal, mechanical, and hydraulic cutting; microwave spalling; and explosives) and other information on dismantling, supported by almost 200 references, is given in [42], Chapter IV.

Pilot *et al.* [50] report on the evaluation of steel cutting techniques under normalised conditions. Five tools (plasma torch, alternating saw, grinder, arc saw, and arc-air) were used to cut mild and stainless steel plates of various thicknesses. It was found that the plasma torch was fastest and the alternating saw the slowest. The arc air and arc saw produced the widest kerfs and thus the most waste. The alternating saw generated the least mass of aerosol.

In [51], Cornu and Pelilet give an overview of the successful dismantling of the AT-1 FBR reprocessing facility at La Hague. This work was a pilot project for the 1989-93 CEC programme for nuclear installation decommissioning. Different technologies and tools were used depending on the radioactivity levels in the cells. Alpha cell dismantling involved direct working whereas hot-cell dismantling involved remote working using electric servo and robot manipulators.

Based on experience from decommissioning a plutonium facility at Sellafield, Hardey [52] reports that both manual and remote plasma arc cutting for size reduction were more cost effective than cold working.

5.4 Surveillance and maintenance

“If decontamination or dismantling activities are deferred in part or in whole for any reason, safety shall remain as the primary concern” [17, §3.2]. Before a facility is put into surveillance and maintenance mode, the risk of potential accidents has to be minimised, for example, through the removal of bulk process radioactive materials and operational waste; and as far as reasonably practicable, any remaining loose contamination should be recovered, contained, or immobilised. A list of activities that should continue to be performed during this phase is given in [1, §6.17].

The UKAEA has developed a comprehensive, consistent and structured approach to developing (what they refer to as Care and Maintenance) plans for its redundant facilities. The overall methodology is described in their Atomic Energy Code of Practice – AECOP 1085, which is discussed in [53].

5.5 Final radiological survey/site restoration

At the completion of decontamination and dismantling activities, a radiological survey of the facility has to be performed to show that the residual activity is acceptably low and within the criteria set by the national regulatory body. The results of the survey “shall be included in the final decommissioning report” [17, §6.13]. This should be in a form that allows it to be accessible to the general public. An example of the content of such a final radiological survey report for a nuclear fuel cycle facility is given in the Annex to [1].

Ideally, following decommissioning the site should be delicensed. In the United Kingdom, NII has already delicensed 12 – minor – sites or parts of sites [6]. In the United Kingdom, the operators’ period of responsibility continues until the HSE/NII is able to advise that, in its opinion, there has ceased to be any danger from ionising radiation from anything on the site [6, §6.3].

Guidance on the Multi-Agency Radiation Survey and Site Investigation Manual (MARSSIM) for use in final surveys of nuclear sites in the United States is given in [54]. It was developed as a consensus document by a number of federal agencies in the United States with an interest in these final surveys.

In the United Kingdom, the NRPB has issued a consultative document [55] in which they suggest that it would be unlikely that significant expenditure would be warranted to reduce risk from radioactivity contaminated land to an average member of the critical group of future site occupants below 10^{-6} per year. This equates to a dose of $20 \mu\text{Sv/y}$. Such a level is consistent with NRPB advice on the level of risk below which the requirement for optimisation would be relaxed in relation to land based solid radioactive waste disposal [56]. Such a value is the same as that in [57] for the broadly acceptable risk for exposure to a member of the public, which is in line with the UK Government's threshold for optimisation regarding radioactive waste discharges as stated in [4]. This $20 \mu\text{Sv/y}$ is below 1% of the typical background in the United Kingdom. IAEA [58] uses an exemption level of $10 \mu\text{Sv/y}$, whereas the US NRC requires that residual radioactivity distinguishable from background radiation results in a total dose to an average member of the critical group of less than $250 \mu\text{Sv/y}$ [59].

6. Summary of decommissioning experience

The available information on decommissioning continues to grow at an increasing rate, supported by CEC's research programme (see, for example, [60] and the OECD/NEA's collaborative ventures). Experience to date shows that:

- In general, decommissioning projects meet their dose budgets and satisfy ALARP. There is no evidence that decommissioning worker doses exceed national and international limits; indeed in general, decommissioning doses are lower than those during operation;
- No major nuclear fuel cycle decommissioning accident has been reported;
- Effective decontamination and materials recycling reduce the amount of waste generated. Nonetheless, decommissioning projects generate considerable amounts of waste.

Information on decommissioning experience is provided in Section 2-2.10.

7. References

- [1] IAEA (2000), "Decommissioning of Nuclear Fuel Cycle Facilities", Safety Standard Series, Draft Safety Guide DS 171, IAEA, Vienna.
- [2] IAEA (1994), "Classification of Radioactive Waste", Safety Series No. 111-G-1.1, IAEA, Vienna.
- [3] CEC (1995), "Decontamination", EUR 16211, Chapter III, Handbook on Decommissioning of Nuclear Installations, EC, Luxembourg.
- [4] HMG (1995), "Review of Radioactive Waste Management Policy (Final Conclusions)", CM 2919, HMG, London.
- [5] HMSO (1993), *Radiological Protection Act*, (RPA 93), London.
- [6] HSE (2001), *Decommissioning on Nuclear Licensed Sites – Guidance for Inspectors*, (Nuclear Safety Directorate), HSE.
- [7] Mason, D. and Temple, C. (1999), "Regulatory Aspects of Decommissioning", Decommissioning of Nuclear Facilities Conference, EA 1127, IBC, London.

- [8] HSE (2001), *Management of Radioactive Materials and Radioactive Waste on Nuclear Licensed Sites – Guidance for Inspectors*, Nuclear Safety Directorate.
- [9] Miller, M.T. and Kinneman, J.D. (1999), “NRC’s Practice for Decommissioning Non-Reactor Facilities”, Chapter 2, *Decommissioning and Restoration of Nuclear Facilities*, The Health Physics Society Summer School, Maddison.
- [10] Sacki, K., and Ezure, H. (1995), “Decommissioning of Nuclear Facilities in Japan”, International Conference on Decommissioning, I.Mech.E., London.
- [11] Reisenweaver, D.W., Laraia, M. (1999), “Decommissioning at the International Atomic Energy Agency”, Chapter 21, *Decommissioning and Restoration of Nuclear Facilities*, The Health Physics Society Summer School, Maddison.
- [12] Laraia, M. (1998), “New Developments and Trends in the International Atomic Energy Agency Programme on Decontamination and Decommissioning Strategies and Technologies”, International Conference on Nuclear Decommissioning, I.Mech.E., London.
- [13] Laraia, M. (2000), “Planning, Management of, and Other Organizational Points in the Decommissioning of Nuclear Facilities: An International Perspective”, Decommissioning Experience Seminar, EA 1136, IBC, London.
- [14] Hammer, P. (1999), “Dismantling Experience Acquired at the French Atomic Energy Commission”, Decommissioning of Nuclear Facilities Conference, EA 1127, IBC, London.
- [15] Gamberini, D.A. (1994), “Decommissioning Using Machine Assistance of the B205 Fuel Reprocessing Pilot Plant, Phase 1 – Preparatory and Engineering Work”, Decommissioning of Nuclear Installations, CEC, Luxembourg.
- [16] Pomfret, D.G. *et al.* (2000), “The Potential Benefits and Drawbacks of Deferring the Decommissioning and Dismantling of a Nuclear Facility”, Proceedings of the 10th International Congress, International Radiation Protection Association, Hiroshima, IRPA 10.
- [17] IAEA (2000), “Pre-disposal Management of Radioactive Waste, Including Decommissioning”, Safety Standards Series No. WS-R-2, IAEA, Vienna.
- [18] Petrasch, P., Dufaud, J.M. and Whitty, S. (1994), “The EC Decommissioning Database on Specific Data Suitable for Cost and Dose Estimates”, EC-DB-COST, Conference on Decommissioning of Nuclear Installations, E.C., Luxembourg.
- [19] Colquhoun, A. (1993), “Sellafield Decommissioning Programme”, Conference on Decommissioning of Nuclear Facilities, E2611, IBC, London.
- [20] Elder, W.F., Brotherton, J.C. and Hutt, S. (1992), “Mathematical Modelling of Nuclear Fuel Reprocessing Plants To Assess Decommissioning Liabilities”, Spectrum ‘92, The Nuclear and Hazardous Waste Management International Topical Meeting, Boise, Idaho.
- [21] Twardowski, T. and Watmough, M.H. (1992), “The Development of a Computer Code for Estimating Radiation Source Terms”, Nuclear Decom ‘92, Decommissioning of Radioactive Facilities, London.

- [22] Taylor, F.E. (2000a), “The Regulation of Shutdown Licensed Facilities in the UK”, International Conference on Decommissioning Nuclear Facilities, EA 1136, IBC, London.
- [23] Taylor, F.E. and Turton, D. (1998), “Regulatory Requirements for the Use of Contractors on Nuclear Licensed Sites”, *Nuclear Energy*, 37(1) 55-58.
- [24] Taylor, F.E. (2000b), “Regulatory View of the Nuclear Licensee as an Intelligent Customer”, *Nuclear Energy*, 39(3) 175-178.
- [25] Robinson, H. (1999, 1997), “Regulatory Experience of ALARA and Decommissioning at UK Nuclear Sites”, First European ALARA Workshop on ALARA and Decommissioning, CEC, Saclay.
- [26] Herbert, A., Wright, E.M. and Goodhill, D.R. (1995), “Cost Effective Safety Cases”, International Conference on Nuclear Decommissioning, I.MechE., London.
- [27] Williams, S. (2000), “Results from 3 Recent Decommissioning and Waste Management Projects in UKAEA”, Decommissioning Experience Seminar, EA 1136, IBC, London.
- [28] Francis, R. (2000), “A Decommissioning Project Managers’ Perspective”, Course on Radioactive Waste Management and Decommissioning, EA 1133, IBC, Cambridge.
- [29] Harris, N. and Gunston, K.J. (1995), “The Development of Criticality Safety Cases in Support of Decommissioning Operations at BNFL, Sellafield”, Proceedings of the 5th International Conference on Nuclear Criticality Safety, Vol. II, Albuquerque, New Mexico.
- [30] Walls, S.J. and Harris, N. (1996), “Criticality Issues in Decommissioning Activities at Sellafield”, Proceedings of ANS/ENS International Meeting – DD&R Embedded Topical, American Nuclear Society, Washington, D.C.
- [31] Ogilvie, F.M. and Harris, N. (1997), “Handling and Disposal of Decommissioning Wastes at BNFL, Sellafield, Criticality Challenges in the Next Decade”, American Nuclear Society, Washington, DC.
- [32] Ha, B.C. and Williamson, T.G. (1994), “Criticality Assessment of Initial Operations at the Defence Waste Processing Facility”, Proceedings of the Symposium on Waste Management, WM ‘94, Vol. I, Tuscon.
- [33] Crouail, P., Lefaire, C. and Croft, J. (1997), “Observations and Recommendations from the 1st EAN Workshop To Improve ALARA – Implementation During Decommissioning”, First European ALARA Network Workshop on ALARA and Decommissioning, CEC, Saclay.
- [34] Yu, C. (1999), “RESRAD Family of Codes and Comparison with Other Codes for Decontamination and Restoration of Nuclear Facilities”, Chapter II, Decommissioning and Restoration of Nuclear Facilities, The Health Physics Society Summer School, Maddison.
- [35] Vallence, P.A. (1997), “ALARA During Major Refurbishment of a Reprocessing Plant”, First European ALARA Network Workshop on ALARA and Decommissioning, CEC, Saclay.
- [36] Teresa, O.M. (1997), “ALARA in the Decommissioning of the ANDUSAR Uranium Mill”, First European ALARA Network Workshop on ALARA and Decommissioning, CEC, Saclay.

- [37] Pomfret, D.G. (1999), “The ALARP Process as a Method of Dose Control in Decommissioning Operations at Sellafield”, First European ALARA Network Workshop on ALARA and Decommissioning, CEC, Saclay.
- [38] Robinson, I.F. (1999), “Regulatory Experience of ALARA and Decommissioning at UK Nuclear Sites”, First European ALARA Network Workshop on ALARA and Decommissioning, CEC, Saclay.
- [39] ICRP (1991), “Recommendation of the International Commission on Radiological Protection”, ICRP Publication 60 Annals of ICRP, Vol. 21 (1-3).
- [40] Poupard, J.F. *et al.* (2000), “Lessons Learnt from Decontaminating and Decommissioning Fuel Cycle Facilities in France”, 7th International Conference on Decommissioning Nuclear Facilities, EA 1131, IBC, London.
- [41] Pflugrad, K.A. (1999), “The European Commission’s Technological Programmes on the Decommissioning of Nuclear Installations”, 6th International Conference on Decommissioning Nuclear Facilities, EA 1127, IBC, London.
- [42] CEC (1995), “Decontamination”, Chapter III, Handbook on Decommissioning of Nuclear Installations, EUR 16211, EC, Luxembourg.
- [43] Hamilton, M.A. *et al.* (1998), “Biodecontamination: Cost Benefit Analysis of a Novel Approach for Decontamination of Massive Concrete Structures”, International Conference on Nuclear Decommissioning, I.Mech.E., London.
- [44] Janssens, A. (1997), “Different Policy Options for the Recycling of Contaminated Scrap Metal”, First European Network Workshop on ALARA and Decommissioning, Radiological Protection, 108, CEC, Saclay.
- [45] Menon, S. (1997), “Recycling of Metal Scrap from Nuclear Installations”, First European Network Workshop on ALARA and Decommissioning, Radiological Protection 108, CEC, Saclay.
- [46] NEA (1996), *Nuclear Decommissioning, Recycling and Re-Use of Scrap Metals*, OECD, Paris.
- [47] IAEA (1992), “Application of Exemption Principles to the Recycle and Re-Use of Materials from Nuclear Facilities”, Safety Series No. 111-P-1.1, IAEA, Vienna.
- [48] IAEA (1992), “Principles for the Exemption of Radiation Sources and Practices from Regulatory Control”, Safety Series No. 89, IAEA, Vienna.
- [49] Campani, M. and Nokhamzon, J.G. (1998), “EDF and CEA’s Dismantling Strategies – Application to EL4 and its Waste Management Mode”, Nuclear Decommissioning ‘98, I.Mech.E., London.
- [50] Pilot, G. *et al.* (1994), “Evaluation of Steel Cutting Techniques”, Decommissioning of Nuclear Installations, CEC, Luxembourg.

- [51] Cornu, F, Pelilet, X. (1993), “Pilot Dismantling of the AT-1 Reprocessing Facility at La Hague”, 4th Seminar in Practical Decommissioning Experience with Nuclear Installations in the European Community, EUR15099, CEC, Mols.
- [52] Hardey, G. (1994), “Decommissioning of the Dry Granulation Plant Using Machine Assistance”, Decommissioning of Nuclear Installations, CEC, Luxembourg.
- [53] Hughes, T. (2000), “Planning for Care and Maintenance of Redundant Nuclear Facilities – AECF 1085”, Decommissioning Experience Seminar, EA 1136, IBC, London.
- [54] NUREG-1575 (1997), “Multi-Agency Radiation Survey and Site Investigation Manual (MARSSIM)”, US NRC, December.
- [55] NRPB-M728 (1996), “Radiological Protection Objectives for Land Contaminated with Radionuclides”, A Consultative Document.
- [56] NRPB (1992), “Radiological Protection Objectives for Land-Based Disposal of Solid Radioactive Wastes”, NRPB, Vol. 3(2).
- [57] HSE/NII (1992), “Safety Assessment Principles for Nuclear Plants”, London.
- [58] IAEA (1996), “International Basic Safety Standards for Protection Against Ionizing Radiation and for the Safety of Radiation Sources”, Safety Series No. 115, IAEA, Vienna.
- [59] Subpart, E., “Radiological Criteria for Licence Termination”, *Standards for Protection Against Radiation*, 10 CFR Part 20, US NRC Regulations, US NRC.
- [60] CEC (1998), “The Community’s Research and Development Programme on Decommissioning of Nuclear Installations”, Fourth Annual Progress Report, EUR 12338EN, CEC.

Chapter 11

SAFETY OF THE TRANSPORT OF RADIOACTIVE MATERIALS

The OECD member countries with a nuclear programme have more than 40 years of experience in the transport of radioactive materials. A great deal of statistical data already exists on the subject.

Specific safety regulations are well-developed and harmonised internationally. Accident situations have been taken into account from the beginning and the transport regulations are framed so that unacceptable radiation exposures should not occur from either radioactivity release or shielding loss even in the case of severe accidents. Actual packages are designed to remain safe in the specified regulatory conditions of rain, stacking, collision, fire, and immersion.

1. Safety considerations and regulations

Unlike the technical safety regulations for plants, which are specific to each state, an international basis has been defined by IAEA [1,2] for transportation safety. Transport safety is based on three main factors:

- first and foremost, the engineered robustness of the packages;
- transport reliability and certain specially equipped vehicles;
- efficient emergency action in the event of an accident.

IAEA recommendations specify package performance criteria. The safety functions to be ensured are containment, radiation shielding, prevention of thermal hazards, and criticality.

The degree of safety of the packages is adapted to the quantity and potential noxiousness of the material transported and determines the type of package to be used. For each type of package (excepted, industrial, A, B, or C), the regulations define the associated safety requirements, together with test standards to be reached.

1.1 Characteristics of various types of packages

Excepted packages are not subjected to any qualification test beyond routine use. However, there are a certain number of general specifications, such as a maximum dose rate at the outer surface of 0.005 mSv/h.

Non-fissile industrial or Type A packages are not designed to withstand accident situations. However, they must withstand mishaps that could occur during transport, handling, or storage operations. They must consequently withstand the following tests:

- exposure to a severe storm (rain fall reaching 5 cm/h for at least 1 hour);

- drop onto a rigid target (rock or concrete or steel) from a height varying according to the weight of the package (maximum 1.2 m) or collision with equivalent energy;
- stacking of 5 packages above the package;
- drop of a 6 kg steel bar onto the package from a height of 1 m.

These tests should give rise to no loss or dispersal of radioactive contents and radiation shielding deterioration must not exceed 20%.

Fissile or Type B packages (Figure 11.1) must be designed to continue to ensure their containment, subcriticality, and radiation shielding functions under accident conditions. These accidents are represented by the following tests:

- a series of three consecutive tests:
 - a 9 m drop test onto a rigid target;
 - a 1 m drop onto an indenting vertical bar;
 - an engulfing 800°C minimum fire for 30 minutes;
- an immersion in 15 m deep water for 8 hours (200 m water depth for spent fuel).

Figure 11.1. Typical type B package (Source COGEMA – France)



Type C packages must be designed to continue to ensure their containment, subcriticality, and radiation shielding functions under severe accident conditions. These accidents are represented by the following tests:

- a series of three consecutive tests:
 - a 9 m drop test onto a rigid target;
 - a 3 m drop onto an indenting conical frustum;
 - an engulfing 800°C minimum fire for 60 minutes;
- an impact on a rigid target at a velocity of 90 m/s;
- an immersion in 200 m deep water for 1 hour.

1.2 Basis for safety requirements

Test specifications for Type B packages are related to potential accident situations and the package is required to be so designed that, if it were subjected to these tests, the integrity of the containment of the radioactive contents and of the shielding would be retained to the extent specified in the IAEA regulations, in which the nature of the contents is taken into account.

The safety tests on Type A packages are based on the premise that the package may be destroyed in a severe accident but the package must withstand normal transport conditions and foreseeable accidents such as a drop in handling, whereas the regulations define the Type B package as being able to withstand severe tests corresponding to accident conditions in transport with reasonable safety margins. Free drop impact and fire are of prime concern for Type B package tests.

- The 9 m drop test is most often considered as severe as the collision of a package on its shipping vehicle on a bridge pile or a concrete wall at a speed of 100 km/h, since a large part of the energy can be absorbed by the crushable structures of the vehicle. Sandia Laboratories at Albuquerque, New Mexico (United States), in 1977 carried out full-size accident tests involving spent fuel flasks and truck and locomotive collisions at speeds higher than 100 km/h [3]. In the United Kingdom in 1984, a full-size test involved a train at speed of 160 km/h crashing into a spent fuel package. The test showed that the package could withstand such an impact [4].
- The fire or thermal test has been specified on the basis of the statistics of plane and oil tank truck fires. Present insulation materials allow packages to withstand fires more severe than those specified in the test regulations.

The validity of the drop tests has been endorsed by several accidents, such as a drop of enriched UF₆ containers from a carriage onto the track at a speed of 100 km/h (Germany, 1972, and United States, 1977), the drop of a spent fuel flask from a highway bridge (United States, 12 December 1970), and from a crane (Belgium, 1973). Some actual accident statistics are shown in Tables 11.1 and 11.2.

The transport of fissile material requires consideration of any problems that might arise in the event of a criticality accident. The IAEA regulations require that fissile material packages have criticality approval and this approval must take into account the results of both the various tests to which the packages have been subjected and the accident assessments. A mechanical impact that could bring into close proximity several independently safe quantities of fissile materials by deforming the packages typifies the remote accident situations that have to be considered for Type B packages in the criticality safety clearance context.

Practical accident scenarios severe enough to damage the containment and give rise to contamination of the environment are difficult to conceive for adequately designed and maintained packages. Contamination levels would depend on the nature and radioactive inventory of the contents and the possibilities for operator intervention [5,6]. Environmental contamination that resulted from any of the terrestrial transport accidents listed in Tables 11.1 and 11.2 was very limited in activity and time and had no consequence to workers or the public.

The possibility of a ship carrying radioactive materials accidentally set on fire or sinking after a collision or another failure has also been considered. Risks from fire and explosion on board the vessel can be mitigated by adequate protective measures. For spent fuel, plutonium, and high activity waste, a specific regulation, the INF code of the IMO [7], has been implemented to prevent and mitigate fires on board ships. Even if a ship were to sink, most packages would survive unless in very deep waters. However, the consequences of package rupture in deep waters are mitigated by the dilution effect so

that radiological consequences on people who consume the sea products are not significant. At lower depths, the gentle failure caused by corrosion will also involve a dilution time. Salvage of the packages after the Mont-Louis shipwreck shows that, in relatively shallow waters, packages can be recovered virtually undamaged (see Section 11-5).

For Type C packages, the performances required for collision and fire resistance are derived from the survey of past accidents recorded for commercial air traffic [8]. They guarantee that the package would remain leaktight and retain sufficient shielding for most of these accidents, including those involving high-velocity impacts or enhanced severity fires.

1.3 Assessment of safety documents

Some materials and package models require the approval of the competent authority before they can be authorised for transport:

- radioactive materials in special form (radioactive sources for instance);
- low dispersible radioactive material;
- Type B, Type C packages, and all fissile material packages;
- packages designed to contain 0.1 kg or more of uranium hexafluoride;
- special arrangement shipments (the package fails to comply with all the requisite criteria, but compensatory transport condition measures have been taken to ensure that transport safety will not be below that of a normal transport operation).

The transport approval certificate is given on the basis of the information specified in the IAEA regulations, together with any additional data which may be requested by competent national authorities, including:

- stress calculations showing that the package would have suitable reliability under normal handling and use as well as in design-basis accident conditions;
- thermal calculations for normal operation and accidental conditions;
- quality assurance data.

These authorisations are usually issued for a period of a few years. Generally speaking, authorisations are given for package models and not package by package. However, manufacturing, operating, and maintenance conditions are consistently specified.

These authorisations are then often issued outside the context of specific transport operations, for which no prior warning of the Safety Authorities is currently required, but which may be subjected to security checks.

2. Industrial participants

The main participants in transport arrangements are the consignor and the carrier. The consignor is responsible for package safety and accepts responsibility by way of the shipment document accompanying the package and handed to the carrier. Other participants are also involved: the package designer, manufacturer, owner, and the carriage commission agent (authorised by the consignor to organise the transport operation).

For a radioactive material shipment to be carried out under good safety conditions, a stringent responsibility chain must be set up. So, for major transport operations:

- The nuclear operator as consignor must be fully aware of the characteristics of the material to be transported to be able to select packaging and specify transport conditions accordingly.
- The corresponding packaging must be designed and sized in compliance with requirements as to conditions of use and current regulations. In most cases, a prototype is needed to carry out the tests prescribed by the regulations. The next stage consists of preparation of the safety file, which will be submitted to the competent authority with the application for authorisation.
- When existing containers are used, their conformity with approved models has to be confirmed. In this context, the container owner must set up a maintenance system in conformity with that described in the safety file and the authorisation certificate.
- The container is sent to the consignor's site, where it will be loaded with the material for transportation. The consignor is responsible for carrying out the inspections (leaktightness, dose rate, temperature, contamination) on the loaded container prior to entering a public road.
- The transport operation itself is organised by the carriage commission agent, who is responsible for obtaining the requisite permits and complying with advance notice requirements on behalf of the consignor. This agent also selects the means of transport, the carrier, and the itinerary in compliance with the above-listed requirements.
- The actual transportation is entrusted to specialised firms that have the necessary permits and vehicles. In particular, the drivers of road-haulage vehicles are required to possess specific permits.

3. Special features of transport of spent fuel

Spent fuels, along with high-level solidified waste, represent the largest quantities of highly radioactive materials that need to be transported. They require the most sophisticated shipping flasks. In order to avoid severe contamination of the inside of these flasks during transport, spent fuel elements with cladding failure are put into special canisters before loading.

There are several transport practices for LWR spent fuels [9]:

- fuel flask loading in the reactor cooling pool, dry transport, spent fuel unloading in a water pool – this practice is currently used in France, Japan, and Sweden;
- in-pool loading, transport in water, and in-pool unloading – this is the current practice in the United Kingdom;
- in-pool loading and dry transport and unloading – this practice is also available in France.

The advantage of wet transport is that it ensures better cooling. The drawback is the necessity to control radiolysis during transport to prevent internal overpressure or even severe mechanical stresses in the event of H_2-O_2 deflagration in the free gas space. It would be undesirable to release any contaminated gas during transport. Any leakage of water from the flask could cause local contamination, and sealing arrangements are made to avoid this.

Since higher temperature and radiation levels may complicate the transport of spent MOX fuels, longer cooling times or thicker shielding may be needed.

Large transport flask technology is well developed for existing reactor fuels. It embraces a wide range of subjects as the following brief summaries indicate.

3.1 Heat transfer

In dry transport, heat is mainly transferred inside the flask by radiation (~10% only by convection). The cladding temperature essentially depends upon surface condition and emissivity level; 400°C is typical for current designs. In wet transport the cladding temperatures are usually kept below 150°C by water convection cooling. Heat is transferred to the flask surroundings by natural convection and radiation.

Sometimes materials included in flask designs for radiation shielding also serve for fire protection purposes. Wet plaster, wet and aluminous cement layers, or hydrated polymer resins are examples. If the flask is involved in a fire, such materials are dehydrated and an efficient insulating layer is formed.

3.2 Radiation shielding

Lead is often used in spite of its unfavourably low melting point (327°C), especially for low-weight packages to be transported by road. Cast iron or steel are also used, but their use can lead to high weight and large dimensions and rail transportation is then preferred. The flask opening is closed by a barrel or sliding door or by bolted or screwed covers. Further shielding is provided by the water (in wet flasks), resin, or polyethylene.

3.3 Mechanical design

The main steel or nodular cast iron flask envelope provides the necessary resistance to impact and puncture. Shock-absorber devices are placed at each end of the flask to reduce the consequences of impact. Removable leak tight plugs are protected by covers.

Transport of spent fuel elements in canisters by truck or by railway is presently the most widespread industrial practice within the continental zones (United States, Europe) [10]. International and national regulations are worked out in detail to prevent radiation hazard in case of incident or accident [1].

Increased attention has been given to transport by ship or barge in the United Kingdom, Canada, Sweden, etc., as a safer and less costly alternative to road and rail transport. Ships owned and operated by nuclear fuel cycle organisations or nuclear power plants provide increased safety since they are specially built or modified for these types of transport. Trained personnel present on the ships is an additional safety asset [10,11,12]. The specific safety features needed for ships carrying some of the most dangerous radioactive materials have been codified by the International Maritime Organization (IMO) [7].

Cask surface contamination issues were raised in Europe in 1998 for rail, road, and sea shipments of spent fuel. Preliminary assessments have confirmed that their occurrence and intensity could be limited by appropriate measures and that their dosimetric impact was in compliance with the recommended dose limits for workers and the public [13,14].

4. Transport of vitrified high-level waste

The problems encountered with the transport of vitrified HLW are very similar to those of spent fuel elements: high gamma radiation and heat output and the presence of neutron radiation.

However, vitrified HLW transport operations raise fewer safety issues than spent fuel element transport due to the very low content of fissile materials, the absence of gaseous radionuclides (such as ^{85}Kr), and the reduced heat output.

The logistics problems to be solved for railway transportation of vitrified HLW are, in principle, the same as for spent fuel.

5. Safety record of transporting radioactive material

Tables 11.1 [15] and 11.2 [16] tabulate the spectrum of radioactive material transport accidents reported in the United States from 1971 to 1996 and in France in 1997 and 1998.

Table 11.1. Package response for accidents reported in the United States between 1971 and 1996

Package type	Number of packages in accident	Estimated number of packages with release of radioactive material
Excepted	–	–
Industrial	155	236
Type A	2 379	219
Type B	91	0
Average per year	101	17

Table 11.2. Package response for accidents and incidents reported in France between 1997 and 1998

Package type	Number of packages in accident or incident	Estimated number of packages with release of radioactive material
Excepted	22	19
Industrial	9	0
Type A	24	3
Type B	18	3
Average per year	36	12

Except for the potential release in the Atlantic Ocean from the packages sunk in the MSC Carla ship described below, the maximum release of contamination in the environment during the accidents that involved French transport-related events in 1997 and 1998 has been estimated at 100 MBq per event. This represents 5 000 times less than the maximum release envisioned by the regulators. None of these events led to significant contamination or irradiation of workers or the public.

Some French and American transport-related events are described below to give a typical overview of some of the most severe accidents recorded in these two countries. Only three of them are clearly related to fuel cycle (Springfields, Mont-Louis and Europe), the other have been kept for the general lessons learnt from them.

5.1 Highway accident, Springfield, Massachusetts, United States (1991)

A drunken driver was travelling south in the northbound lanes without headlights. The car struck and glanced off a tractor/trailer that was transporting 12 packages of fresh reactor fuel. Each package contained 2 assemblies. The responding Fire Department reported that the tractor/trailer struck the right safety guard rail, then the centre guard rail, causing the saddle gasoline tank to rupture. The fuel in the saddle tank ignited and the tractor/trailer was engulfed in flames. There was no release of radioactivity, contamination of the environment, or any subsequent injuries and deaths attributable to released radioactivity.

5.2 Train collision, Kenefick Siding, Kansas, United States (1997)

Two trains collided. The 25th rail car of one train contained radioactive material. Both the rail car and its contents were consumed in a fire as a result of the accident. There was no release of radioactivity, contamination of the environment, or any subsequent injuries or deaths attributable to released radioactivity.

5.3 Aircraft fire, Newburg, New York, United States (1996)

While an aircraft was en route to Boston, Massachusetts, from Memphis, Tennessee, smoke alarms in four sections activated. The crew diverted the aircraft to Newburg, New York, and upon landing exited along with another non-member observer. The plane was subsequently engulfed in flames, which were ignited by an undetermined source. There were 8 Type A and 2 Type B packages aboard, none of which released their contents. There was no release of radioactivity, contamination of the environment, or any subsequent injuries or deaths attributable to released radioactivity.

5.4 Trolley/train collision, Montpellier railway station, France (1983)

A collision between a train and a luggage trolley that was crossing the line led to the break of one technetium generator that contained an activity less than 15 GBq, which was carried by the trolley. The cab of the locomotive and the ballast of the track were contaminated; 19 people screened for contamination gave positive results, which were not found to be significant. The resulting contamination was not grounds for concern in view of the limited quantities involved and the short half-lives of the radionuclides.

5.5 Mont-Louis shipwreck, North Sea (1984)

On the North Sea 15 km off Ostend, the French freighter Mont-Louis was rammed by a ferry boat. Badly holed, the ship sank a few hours later on a sand bank at a depth of 15 m at low tide, with its cargo of 30 Type 48Y industrial containers full of uranium hexafluoride enriched by less than 1% representing a total mass of 350 tonnes of UF₆. All 30 containers were retrieved despite bad weather and difficult access to the hold where they were stowed. One or two of the containers had leaked, after damage to their valves, resulting in the ingress of some 50 litres of water. During the operation, 700 analyses (at the surface and in deep water) were carried out but no radioactivity was detected. This event contributed to the implementation of new regulatory provisions to take into account the chemical toxicity of uranium hexafluoride.

5.6 *MSC Carla shipwreck, Atlantic Ocean (1997)*

As a result of violent force 10 to 12 winds and the effect of a rogue wave, a container ship broke in two North of the Azores. The cargo in the front section of the ship included three biological irradiators of French origin containing sealed ^{137}Cs encapsulated in approved special form, with a total activity of 330 TBq. The front section of the ship sank to a depth of 3 000 meters five days later. Since the impact via seafood consumption for individuals in the population had been assessed around 1 pSv (10^{-9} mSv), and since the sources were beyond actual fishing depths, recovery of the sources was not planned.

5.7 *Package and vehicle contamination, Europe (1998)*

Every year, some 200 packages containing spent fuel leave European nuclear power plants for the COGEMA reprocessing plant at La Hague, France. Almost all the packages go by rail to the terminal at Valognes, where they are unloaded and continue by road to the La Hague reprocessing facility 30 km away. COGEMA checks the packages and railcars for surface contamination at their arrival at Valognes. In 1997, one third of the convoys exhibited surface contamination on at least one point that exceeded the regulatory limit set at 4 Bq/cm². The facts were confirmed during a surveillance inspection conducted jointly by the Competent Authorities in charge of safety and radiation protection. It was established that the incidents had no effect on health but were indicative of slackness in operations of contamination prevention and wash out of these packages at reactor sites.

5.8 *Highway truck fire, Langres, France (1999)*

A truck carrying 900 smoke detectors in 3 excepted packages burned on a highway. Each smoke detector contained a sealed source of americium-241, and the total activity of the cargo was 4 MBq. The truck was also carrying combustible liquids (paint, oil and alcohol). The fire initiated in the brakes and was extremely violent (lasting for 2 to 3 hours); the trailer was destroyed. The firemen and the Langres Highway Gendarmes Unit intervened without being informed that the cargo was radioactive. The violence of the fire obliged the firemen to wear breathing masks. The burned trailer was transported to a scrap merchant, and the fire wastes were transported to a “conventional” trash dump. Urine samples indicated that the firemen did not receive significant doses. At the fire location, alpha contamination equal to 10 times the background level was recorded over a 1 m² area. The result of the soil sampling showed a 4 kBq/kg activity. A lower activity was also detected down the highway, caused by the spillage of water used by the firemen. The burned chassis of the truck trailer (stored by a scrap merchant) showed spot contamination and burned debris were found with an activity of 12 kBq/kg.

6. References

- [1] IAEA (1985), *Regulations for the Safe Transport of Radioactive Materials* (1985 Edition), Safety Series No. 6, IAEA, Vienna.
- [2] IAEA (1996), *Regulations for the Safe Transport of Radioactive Material*, TS-R-1 (ST-1, revised), IAEA, Vienna.
- [3] McClure, J.D. (1980), “Relative Response of Type B Packagings to Regulatory and Other Impact Test Environments”, PATRAM 80, p. 555.

- [4] Toxic Materials Transport 5 (1984), “Spent Nuclear Fuel Flask Survives British Crash Test”, (16), July.
- [5] ANS (1977), “Preliminary Risk Analysis of the Transportation of Nuclear Wastes”, *Transactions of the American Nuclear Society*, Vol. 25 (1), Supplement.
- [6] Van Otterloo, R.W. (1977), “Risk Analysis of the Road Transport of Radioactive Wastes in the Netherlands”, *Transactions of the American Nuclear Society*, Vol. 25 (1), Supplement.
- [7] IMO (1993), *Code for the Safe Carriage of Irradiated Nuclear Fuel, Plutonium and High Level Radioactive Wastes in Flasks on Board Ships*, International Maritime Organization, INF Code.
- [8] Raffestin, D. (1998), “Risk Assessment of Accident Associated with Aircraft Transportation”, PATRAM 98, pp. 1467-1471.
- [9] Baillif, L. *et al.* (1987), “Spent Fuel Unloading and Storage at La Hague”, RECOD-87, Vol. 1, pp. 341-435.
- [10] IAEA (1984), *Guidebook on Spent Fuel Storage*, Technical Reports Series No. 240, IAEA, Vienna, pp. 54-70.
- [11] Carter, T.J. *et al.* (1987), *Development of Systems for Transporting Irradiated CANDU Fuel in Ontario*, RECOD-87, Vol. 1, pp. 361-368.
- [12] Gustafson, B. (1982), “Design and Working Environment of the Central Temporary Storage Facility and Sea Transport System, Presently under Realization in Sweden”, *Transactions of the American Nuclear Society*, Trans ENC-3, Brussels, Vol. 40, pp. 146-149.
- [13] Common Report of the Competent Authorities of France, Germany, Switzerland and the United Kingdom (1999), “Surface Contamination of Nuclear Spent Fuel Shipments”, *International Journal of Radioactive Materials Transport*, Vol. 10, No. 2, pp. 73-84.
- [14] IAEA (1999), “Spent Fuel Storage and Transport Cask Decontamination and Modification”, TECDOC-1081, IAEA, Vienna, April.
- [15] McClure, J.D. *et al.* (1998), “Radioactive Material Transportation Accident and Incident Experiences in the USA (1971-1997)”, PATRAM 98, pp. 363-370.
- [16] Rancillac, F. *et al.* (1999), “Declarations of Transport Accidents and Incidents in France and Contribution to the IAEA Database EVTRAM”, *International Journal of Radioactive Materials Transport*, Vol. 10, No. 1, pp. 21-26.

Chapter 12

SAFETY RECORDS OF FUEL CYCLE FACILITIES

1. Personnel irradiation dose

Collective dose, when provided hereafter for an individual facility, may vary considerably from year to year, depending on many parameters. Its general trend is provided as an indicator of the radiation protection efficiency, that is to say the ability of the operator to control radiation spread through efficient operation and maintenance. It should not be used in such case as a health indicator.

1.1 Uranium mining and milling

No data available.

1.2 Enrichment

1.2.1 Japan enrichment and fuel fabrication

Table 12.1. Average annual exposure for Japanese enrichment and fuel fabrication facilities

Fiscal Year ²⁾	Number of Licensees	Number of Personnel engaged in radiation works ¹⁾	Total dose (man*mSv)	Average dose (mSv)
1986	5	1706	460 ⁴⁾	0.3
1987	6	1779	470 ⁴⁾	0.3
1988	6	1759	440 ⁴⁾	0.3
1989	6	1920	435	0.2
1990	6	2067	508	0.2
1991	7	2616	526	0.2
1992	7	3007	591	0.2
1993	7	3034	636	0.2
1994	7	2911	471	0.2
1995	7	2712	445	0.2
1996	7	2741	291	0.1
1997	7	2685	275	0.1
1998	7	2755	261	0.1
1999 ³⁾	7	2661	746	0.3
2000	6	2655	200 ⁴⁾	0.1
2001	6	2645	390 ⁴⁾	0.1
2002	6	2707	400 ⁴⁾	0.1

1) Laboratory-scale facilities are not included.

3) Exposure associated with JCO criticality event is excepted.

2) From April to March

4) Significant figure is two.

1.2.2 US enrichment and fuel fabrication

The NRC collects exposure information from five broad classes of licensees (low-level waste management is monitored by individual states):

- industrial radiography;
- manufacturing and distribution;
- independent spent fuel storage;
- fuel cycle;
- commercial power reactors.

To place exposures in context, the following collective information was recorded in 2001:

- Total number of workers with measurable dose: 76 028.
- Total collective dose: 147 460 man.mSv (14 746 man.rem).

For year 2001, 50 workers received exposures between 40 and 50 mSv (4 and 5 rem), and none higher. For the ten-year period 1992-2001 only one worker received an annual dose greater than 120 mSv (12 rem).

There are NRC-licensed facilities for both fuel fabrication and, since 1997, enrichment. Table 12.2 [1] lists exposure data for these licensees for the period 1992-2001.

Table 12.2. Average annual exposure for US fabrication, processing, and enrichment employees

Calendar year	Number of licensees	Workers with measurable dose	Total TEDE* in man.mSv (man.rem)	Average dose in mSv (rem)
1992	11	5 061	5 450 (545)	1.1 (0.11)
1993	8	2 611	3 390 (339)	1.3 (0.13)
1994	8	2 847	11 470 (1 147)	4.0 (0.40)
1995	8	2 959	12 170 (1 217)	4.1 (0.41)
1996	8	3 061	8 780 (878)	2.9 (0.29)
1997	10	3 910	10 060 (1 006)	2.6 (0.26)
1998	10	3 613	9 500 (950)	2.6 (0.26)
1999	9	3 927	10 200 (1 020)	2.6 (0.26)
2000	9	4 649	13 390 (1 339)	2.9 (0.29)
2001	9	3 980	11 620 (1 162)	2.9 (0.29)

* Total effective dose equivalent is the sum of the deep dose equivalent (for external exposures) and the committed effective dose equivalent (for internal exposures).

For the past five years the number of exposed workers, the collective dose, and the average dose have remained relatively constant. The average annual dose per exposed worker is about 3 mSv (or 0.3 rem with the unit of dose used in this national reporting system).

In 2001, there were 21 licences for the on-site (temporary) storage of spent fuel. In 2001 there were 107 workers with a measurable dose. The total exposure for these workers was 130 man.mSv (13 man.rem). No worker exceeded 7.5 mSv (0.75 rem).

The long-term trend, since 1996, at about 3 mSv (0.3 rem) average measurable annual dose per fuel cycle worker is consistent with the average measurable exposure per worker in the commercial light-water reactor industry, although recent reactor data are trending downward.

1.3 Uranium dioxide fuel element fabrication

1.3.1 Framatome ANP, Dessel, Belgium

Table 12.3. Occupational radiation doses – Dessel uranium fuel plant, Belgium

Year	Total dose man.mSv	Average effective dose mSv	Number of workers
1995	173	0.64	270
1996	304	0.86	353
1997	154	0.53	291
1998	158	0.70	226
1999	204	0.93	219
2000	139	0.62	224
2001	218	0.88	248
2002	149	0.57	261
2003	158	0.66	239

1.3.2 Framatome ANP, Romans, France

Table 12.4 below shows the external dose statistics of the whole population of workers (Framatome-ANP and contractors) working on Romans site.

Table 12.4. Occupational external doses – Romans uranium fuel plant, France

Year	Total dose man.mSv	Average effective dose mSv	Total number of workers
1995	459	0,71	644
1996	585	0,69	847
1997	472	0,61	769
1998	<i>377</i>	<i>0,67</i>	<i>566</i>
1999	<i>381</i>	<i>0,64</i>	<i>599</i>
2000	1 195	1,48	806
2001	223	0,23	967
2002	130	0,14	954
2003	111	0,11	1 031

For years 1998 and 1999 (in italic letters), category B workers are not taken into account. (Workers are categorised B when in usual working conditions, their annual effective dose might not exceed 6 mSv. When doses of category A workers – that might exceed 6 mSv/y – are recorded on a monthly or quarterly basis, the doses of category B workers are generally recorded on an annual passive dosimeter. This is always the case in Romans.)

For year 2000 (in bold letters) the figures indicate the total of internal and external doses.

Table 12.5 below shows the internal dose statistics of the part of the whole population of workers (Framatome-ANP and contractors) working on Romans site that is exposed to internal doses.

Table 12.5. Occupational internal doses – Romans uranium fuel plant, France

Year	Total dose man.mSv	Average effective dose mSv	Number of workers with internal doses
1995	/	/	/
1996	1 040	3.80	274
1997	931	3.55	262
1998	742	3.24	229
1999	915	3.44	266
2000	*	*	*
2001	664	2.11	314
2002	336	0.72	465
2003	283	0.67	425

* Results for year 2000 are aggregated with external dose results in Table 12.4.

It has to be noted that internal doses are calculated by the Company Doctor from the individual results of radio-toxicological analyses from excreta and of anthropogammametry. The results are then quite realistic and great care should be taken when comparing them with values simply calculated from the results of global area contamination monitoring and assessment of the residence time of the workers in each area.

1.3.3 Framatome ANP, Lingen, Germany

Table 12.6. Occupational radiation doses – Lingen uranium fuel plant, Germany

Year	Average individual mSv	Collective man.mSv	Breakdown of the population according to dose group				Total number of workers
			0.2<D<2	2≤D<5	5≤D<10	10≤D	
1994	0.69	197.0	120	20	3	0	143
1995	0.41	120.8	124	5	2	0	131
1996	0.46	145.7	171	18	0	0	189
1997	0.60	180.9	161	25	0	0	186
1998	0.77	228.0	182	34	0	0	216
1999	0.39	128.8	143	8	0	0	151
2000	0.34	111.8	112	13	0	0	125
2001	0.26	83.6	94	7	0	0	101
2002	0.20	64.0	79	3	0	0	82
2003	0.22	68.5	74	5	0	0	79

1.3.4 Japan fuel fabrication

Japan records are grouped with Japan enrichment records above.

1.3.5 Juzbado fuel fabrication facility, Spain

Register levels are 0.10 mSv for external dose, 0 for internal dose.

Table 12.7. Average dose for utility workers – Juzbado fuel fabrication facility, Spain

Year	External dose man.mSv	Internal dose man.mSv	Number of workers	Total dose man.mSv	Average effective dose mSv
1992	34.29	73.66	211	107.95	0.51
1993	30.98	64.95	232	95.93	0.41
1994	16.61	59.92	288	76.53	0.27
1995	14.35	84.75	292	99.10	0.34
1996	20.13	118.12	297	138.25	0.47
1997	29.27	85.51	297	114.78	0.39
1998	18.29	67.81	299	86.10	0.29
1999	19.30	57.48	302	76.78	0.25
2000	18.32	89.58	306	107.90	0.35
2001	24.64	87.61	297	112.25	0.38
2002	42.70	82.81	302	125.51	0.42

Figure 12.1. Average dose (external + internal) for utility workers – Juzbado fuel fabrication facility, Spain

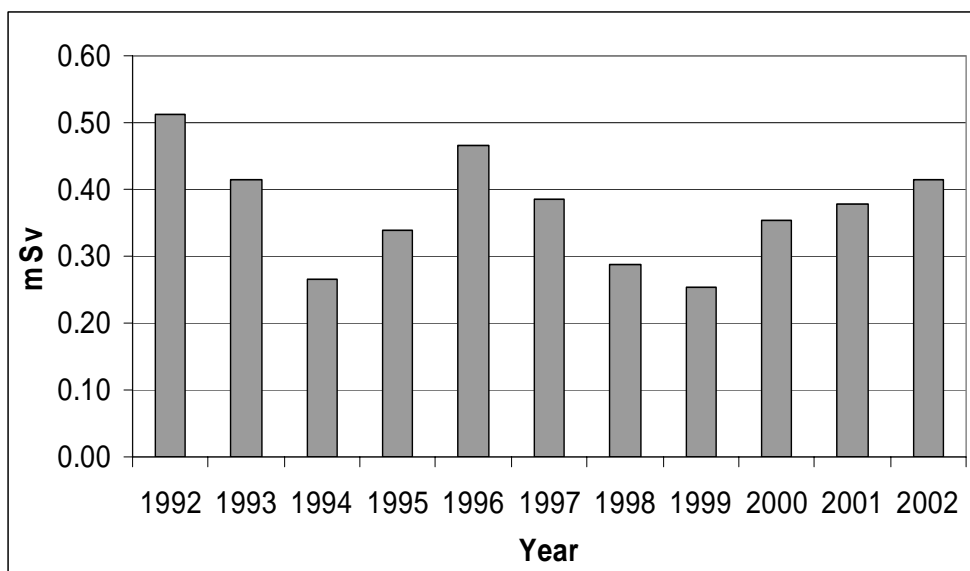

1.3.6 Springfields Fuel Manufacturing Plant United Kingdom

Table 12.8. Occupational radiation doses – Springfields fuel manufacturing plant, United Kingdom

Year	Average individual dose (mSv) ^{(1) (2)}
1995	1.1
1996	1.0
1997	1.0
1998	0.8

(1): Sum of external dose received and committed dose from radionuclides deposited internally.

(2): Average of UOC refinement and uranium, and uranium oxide, production.

1.3.7 United States fuel fabrication

United States records are grouped with US enrichment records above.

1.4 Mixed oxide fuel element fabrication

1.4.1 Belgonucléaire, Dessel, Belgium

Table 12.9. Occupational radiation doses – Dessel MOX fuel manufacturing plant, Belgium

Year	Average individual mSv	Collective man.mSv	Breakdown of the population according to dose group				
			0<D<5	5<D<15	15<D<30	30<D<40	40<D<50
1984	12.59	1,420	24.8%	44.2%	20.4%	7.1%	3.5%
1985	4.83	640	68.4%	23.3%	7.5%	0.8%	0.0%
1986	4.97	730	68.5%	21.9%	9.6%	0.0%	0.0%
1987	6.51	1 165	63.7%	20.1%	12.3%	2.8%	1.1%
1988	7.40	1 503	55.7%	25.6%	14.8%	3.9%	0.0%
1989	6.97	1 484	57.7%	23.9%	15.5%	2.8%	0.0%
1990	7.38	1 630	56.1%	24.9%	17.2%	1.8%	0.0%
1991	5.83	1 306	57.1%	29.0%	13.8%	0.0%	0.0%
1992	6.58	1 461	54.5%	29.3%	15.3%	0.9%	0.0%
1993	5.51	1 213	56.8%	31.4%	11.8%	0.0%	0.0%
1994	6.21	1 385	51.1%	36.3%	12.6%	0.0%	0.0%
1995	4.52	1 043	57.1%	41.6%	1.3%	0.0%	0.0%
1996	5.76	1 314	50.4%	49.6%	0.0%	0.0%	0.0%
1997	5.38	1 269	54.7%	40.3%	5.1%	0.0%	0.0%
1998	4.32	1 055	54.9%	20.9%	16.8%	7.4%	0.0%
1999	4.29	1 067	53.8%	22.1%	18.1%	6.0%	0.0%
2000	4.80	1 213	50.6%	20.2%	21.3%	7.9%	0.0%
2001	4.57	1 193	53.3%	18.4%	17.2%	11.1%	0.0%
2002	3.53	1 190	63.5%	15.1%	17.8%	3.6%	0.0%
2003	3.71	1 103	58.6%	20.2%	20.2%	1.0%	0.0%

Change in breakdown definition corresponds to transition to ICRP 60 recommendations.

1.4.2 MELOX, Marcoule, France

Table 12.10 gives occupational dose records of the MELOX MOX fuel plant, for the total of MELOX personnel and contractors, Table 12.11 records for MELOX personnel only. Only this last table can be compared to most other fuel fabrication plants records.

Table 12.10. Total occupational doses (contractors inc.) – MELOX fuel plant, France

Year	Total dose man.mSv	Average effective dose mSv	Total number of workers
1995	49	0.03	1 953
1996	976	0.40	2 445
1997	1 175	0.53	2 200
1998	1 084	0.54	2 011
1999	1 475	0.72	2 058
2000	1 195	0.69	1 721
2001	1 579	1.11	1 424
2002	1 815	1.66	1 092

Table 12.11. Occupational doses MELOX workers – MELOX fuel plant, France

Year	Total dose man.mSv	Average effective dose mSv	Number of MELOX workers
1995	36	0.10	354
1996	275	0.77	359
1997	301	0.77	391
1998	312	0.74	422
1999	456	0.96	473
2000	531	1.08	492
2001	775	1.45	536
2002	956	1.99	479

It has to be noticed that from 2001 included, the measuring process takes into account ICRP 60 recommendations that simultaneously increase the depth of biological tissue considered and the quality factor of neutron emission. Neutron doses are thus increased by nearly 40% for the same measurement indication. This practically increases global doses by around 20%. During the considered 1995-2002 period, throughput of the plant has been continuously increasing.

1.5 Reprocessing

1.5.1 La Hague, France

Displayed data (whole body dose) are valid for all personnel of La Hague site controlled by the Health Physics staff, including personnel from subcontractors. In 2002, the average individual dose was 0.06 mSv/y (it was 0.5 in 1991) and collective dose was 0.37 man.Sv (it was 3.4 in 1991).

Collective dose per gigawatt-year produced by the treated fuel has decreased by a factor of roughly 1 000 in around 30 years, roughly by a factor 10 every 9 or ten years. It could be however that

the decrease is now asymptotic to around 0.010 man.Sv/GWy. Figure 12.2 shows the evolution of this parameter for the last twenty years.

Figure 12.2. Collective dose per GWy produced by the treated fuel, La Hague, France

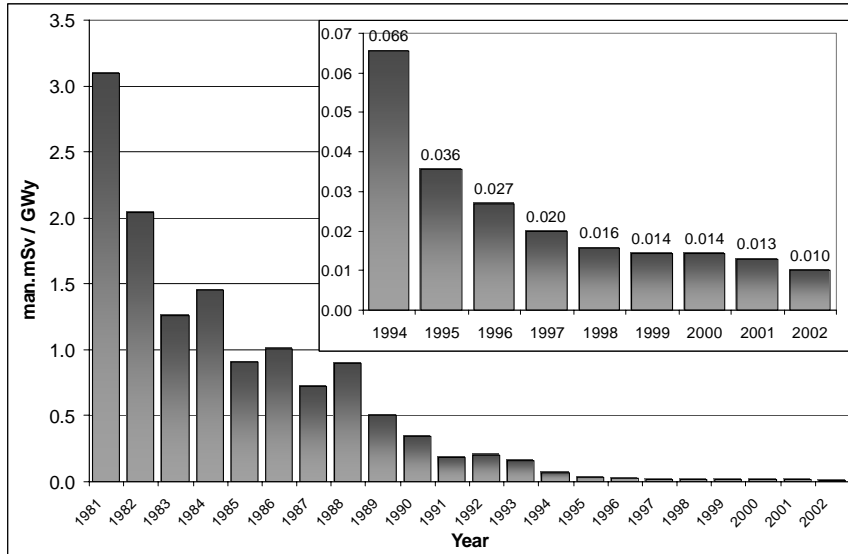

1.5.2 JNC and JNFL, Japan

Figures include JNC Tokai Reprocessing Plant from 1986 to 2002 and JNFL Rokkasho mura plant from 1997 to 2002. Laboratory-scale facilities are not included.

Table 12.12. Average annual exposure for Japanese reprocessing facilities

Fiscal Year ¹⁾	Number of Licensees	Number of Personnel engaged in radiation works	Total dose (man*mSv)	Average dose (mSv) ²⁾
1986	1	1481	730 ³⁾	0.5
1987	1	1651	1550 ⁴⁾	0.9
1988	1	2280	4460 ⁴⁾	2
1989	1	2286	1585	0.7
1990	1	2318	653	0.3
1991	1	2173	466	0.2
1992	1	2512	742	0.3
1993	1	2953	1482	0.5
1994	1	2934	331	0.1
1995	1	3071	308	0.1
1996	1	3423	223	0.1
1997	2	3759	290	0.1
1998	2	4410	422	0.1
1999	2	4286	298	0.1
2000	2	3652	110 ³⁾	0.0
2001	2	3831	340 ³⁾	0.1
2002	2	4746	1050 ⁴⁾	0.2

1) From April to March
3) Significant figure is two.

2) Value of 0 indicates less than 0.05.
4) Significant figure is three.

1.5.3 Sellafield, United Kingdom

Figure 12.3 and 12.4 show the collective dose and the individual average dose received by workers at the Sellafield Site from the first operations with radioactive materials in 1951 until 2002. The collective dose received to operate the Site increased during the 1950s as the site's throughput increased. During the 1960s and 1970s the development of civil nuclear power and further increases in throughput required the construction of new facilities which benefited from the lessons learned during the early 1950s. The collective dose to operate the Site initially reduced, realizing the benefits of the newer facilities, but then began to increase again as the facilities aged. Reductions in dose limits in the late 1970s and a change in emphasis for radiological protection from a regime of compliance with dose limits to one of optimising collective doses had a significant effect on the way dose was managed. The initial phases of new control regimes planned during the late 1970s and introduced during the early 1980s in recognition of the changing environment concentrated at first on engineering measures, for example additional shielding and the provision of new or upgraded facilities. Significant dose reductions resulted even though the volume of work conducted on the site increased, in particular the beginnings of work to retrieve and treat historical wastes for eventual disposal.

Figure 12.3. Collective dose, Sellafield site, United Kingdom

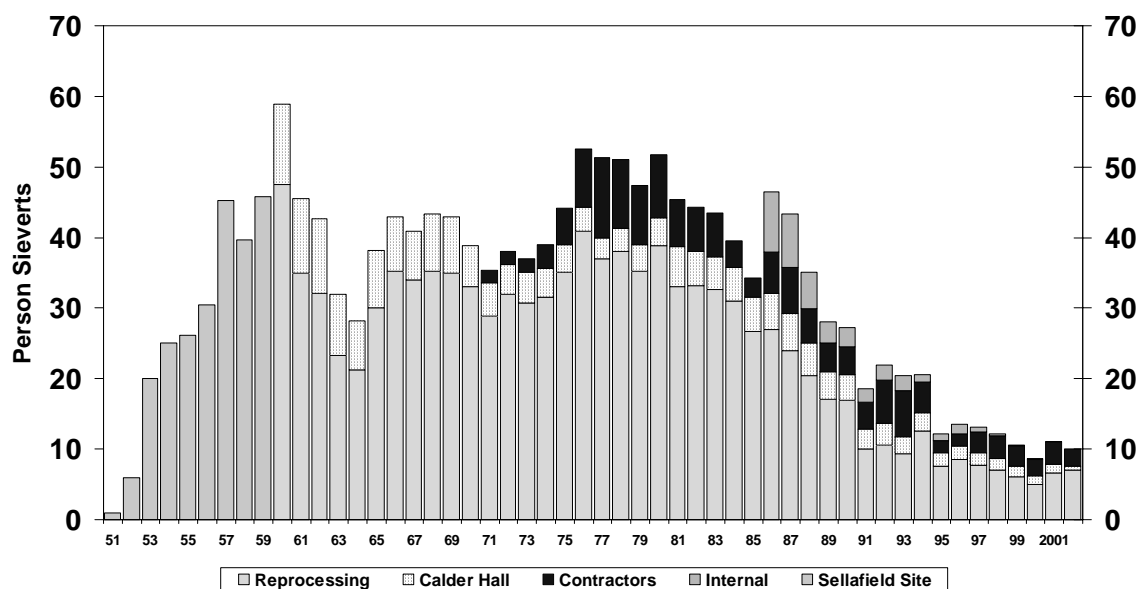

Further constraints on doses during the early 1990s arising from epidemiological studies coupled with increasing emphasis on the need to control and limit individual risks lead to the realisation that radiation dose was a commodity which could be managed in an optimum manner. Dose reduction schemes introduced at this time in a joint effort between management and workforce concentrated on analysis and optimisation of working methods. From the late 1980s it was also recognised that individuals' behaviours were a major influence on the doses they received; if they were aware of the environmental conditions in which they were working and of the influence of their own actions they could control their doses very effectively. Technological developments in personal dosimetry, such as personal alarmed dosimeters and personal air samplers, helped to provide that awareness. In addition to the time honoured methods of dose control, time, distance and shielding, is now added "culture". The net effect has been to reduce the total dose to operate the site by a factor of 5 while the work completed has more than doubled. The overall trend for occupational doses

continues to be downward but work programmed for the coming years to decommission redundant facilities will increase pressure on doses and may result in the trend being reversed.

Figure 12.4. Average individual dose, Sellafield site, United Kingdom

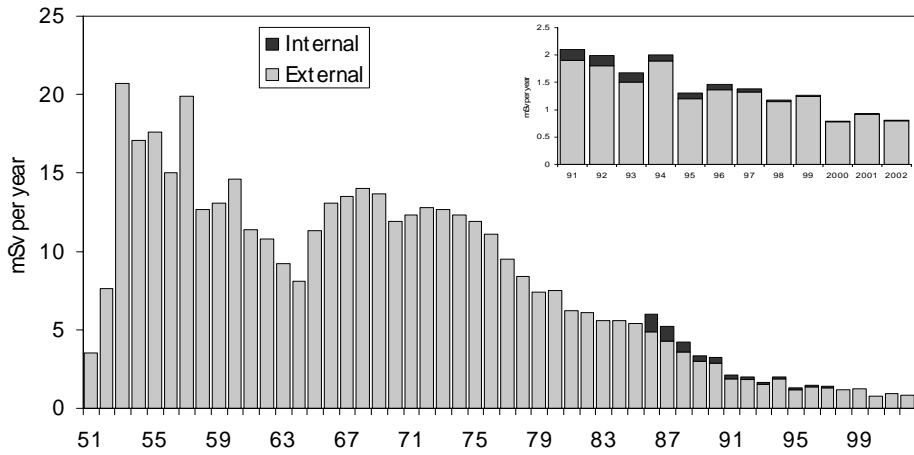

Following chart, for 1951-2002 period, includes Calder Hall and contractors.

2. Waste discharges

The following charts, taken from the MARINA II report of the European Union, set in perspective the different discharges of radioactive waste in the North-East Atlantic region (including North Sea). They are of course pertinent only for this region, not for the whole world.

Figure 12.5. Total alpha discharges to the North-East Atlantic

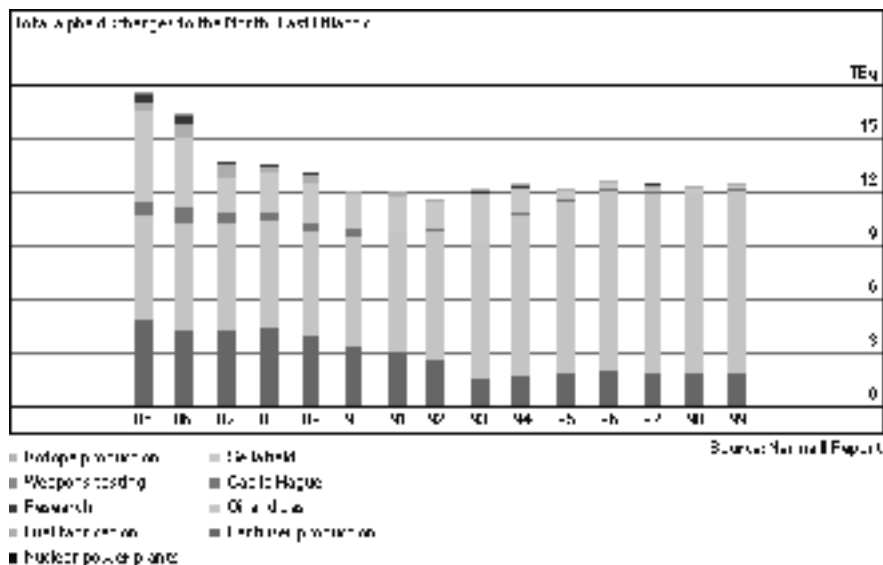
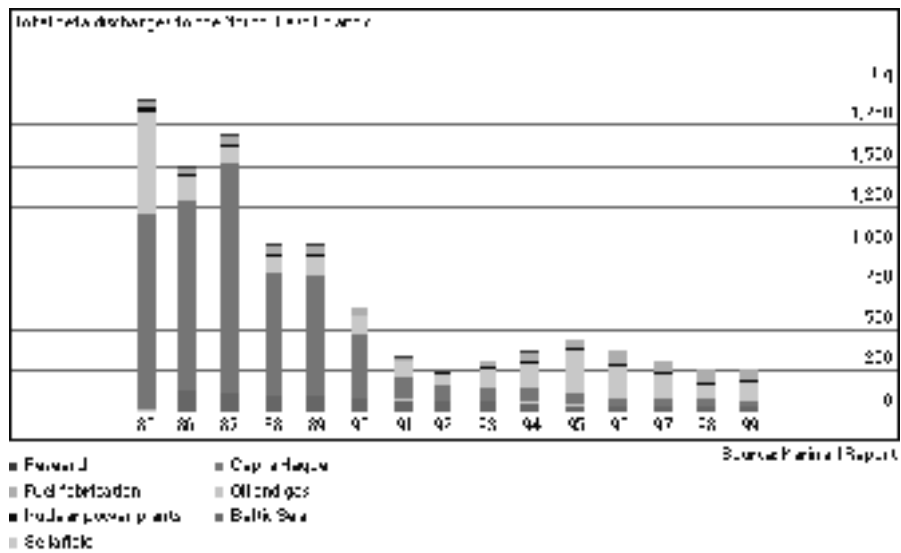

Figure 12.6. Total beta discharges to the North-East Atlantic



2.1 Uranium mining and milling

No data available.

2.2 Enrichment

No data available.

2.3 Uranium dioxide fuel element fabrication

2.3.1 Juzbado fuel fabrication facility, Spain

Figure 12.7. Gaseous waste discharges – Doses to public reference groups, Juzbado fuel fabrication facility, Spain

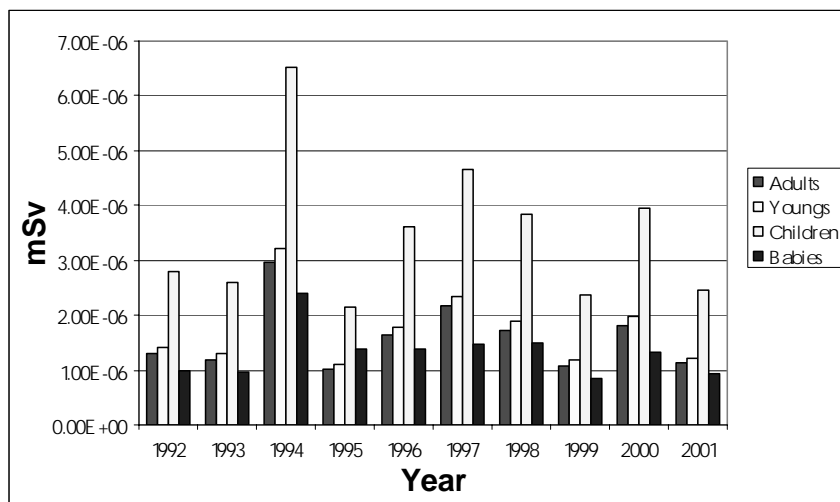
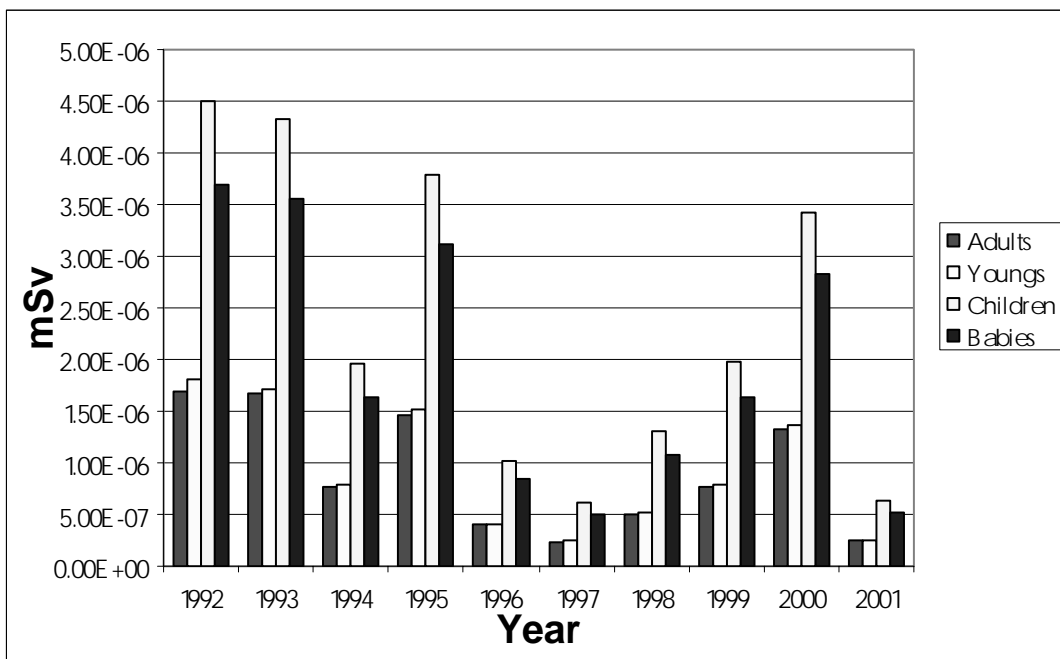

Figure 12.8. Liquid waste discharges – Doses to public reference groups, Juzbado fuel fabrication facility, Spain



2.3.2 Springfields fuel manufacturing plant, United Kingdom

Table 12.13. Waste discharges – Radiation doses to members of the public, Springfields fuel manufacturing plant, United Kingdom

Year	Dose to individual members of most exposed group (μSv) ^{(1) (2)}
1995	24
1996	34
1997	17
1998	15
1999	10

(1): External dose, mainly from UOC refinement.

(2): The group can vary from year to year depending on what a group does and time spent.

2.4 Mixed oxide fuel element fabrication

No data available.

2.5 Reprocessing

2.5.1 La Hague, France

Figure 12.9. Waste liquid discharges, La Hague, France

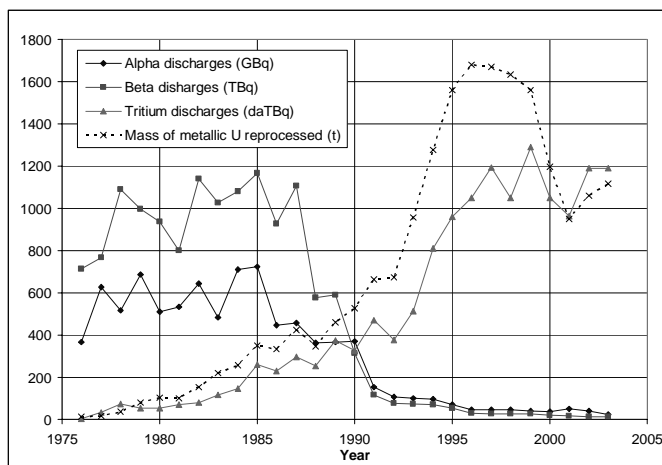

Table 12.14. Waste atmospheric discharges, La Hague, France (in Bq)

Year	H3	Gas other than H3	Halogens	Aerosols
1980	9.2E+12	3.0E+16	1.8E+10	6.8E+07
1981	1.0E+13	3.6E+16	1.1E+10	5.6E+07
1982	6.3E+12	5.1E+16	1.5E+10	3.2E+07
1983	8.3E+12	5.0E+16	2.2E+10	2.8E+07
1984	8.5E+12	2.7E+16	2.8E+10	3.5E+07
1985	3.3E+13	7.1E+16	2.2E+10	6.8E+08
1986	6.1E+12	2.9E+16	1.1E+10	4.0E+07
1987	1.5E+13	3.5E+16	1.5E+10	5.3E+07
1988	2.1E+13	2.7E+16	2.2E+10	2.3E+07
1989	2.5E+13	4.2E+16	2.8E+10	2.1E+07
1990	2.5E+13	6.3E+16	1.9E+10	2.0E+07
1991	2.8E+13	1.0E+17	2.4E+10	2.4E+07
1992	3.0E+13	9.5E+16	1.1E+10	8.8E+06
1993	4.2E+13	1.2E+17	1.1E+10	7.2E+06
1994	5.5E+13	1.8E+17	2.2E+10	9.8E+06
1995	8.4E+13	2.3E+17	3.3E+10	1.9E+07
1996	7.5E+13	2.6E+17	4.0E+10	1.8E+07
1997	7.6E+13	3.0E+17	1.9E+10	2.9E+07
1998	7.2E+13	3.2E+17	1.7E+10	4.5E+07
1999	8.0E+13	3.0E+17	8.1E+09	1.2E+08
2000	6.7E+13	2.3E+17	6.8E+09	1.1E+08
2001	6.2E+13	2.3E+17	4.5E+09	2.4E+08
2002	6.3E+13	2.5E+17	5.5E+09	1.9E+06
2003	6.7E+13	2.5E+17	5.2E+09	1.8E+06

2.5.2 Tokai mura, Japan

Table 12.15. Waste discharges, JNC, Tokai mura, Japan

Fiscal Year ¹⁾	⁸⁵ Kr(Bq)	³ H(Bq)	¹²⁹ I(Bq) ²⁾
1979	1.8E+15	8.5E+11	3.2E+08 ³⁾
1980	7.4E+15	3.5E+12	7.0E+08 ³⁾
1981	7.8E+15	3.6E+12	4.1E+08
1982	7.8E+15	4.1E+12	5.6E+08
1983	1.8E+14	1.5E+12	9.3E+07
1984	1.3E+15	6.7E+11	4.1E+07
1985	1.0E+16	2.8E+12	1.0E+09
1986	1.3E+16	2.7E+12	2.3E+08
1987	1.2E+16	3.7E+12	1.4E+08
1988	2.7E+15	2.5E+12	8.5E+07
1989	9.8E+15	3.7E+12	2.4E+08
1990	1.3E+16	4.2E+12	2.4E+08
1991	1.5E+16	3.2E+12	3.0E+08
1992	9.8E+15	2.8E+12	3.0E+08
1993	5.3E+15	2.2E+12	1.1E+08
1994	1.8E+16	5.4E+12	3.3E+08
1995	8.6E+15	3.8E+12	1.6E+08
1996 ⁴⁾	1.2E+16	3.7E+12	1.6E+08
1997	1.6E+12	1.5E+12	N.D.
1998	6.4E+10	1.2E+12	2.8E+06
1999	3.2E+10	1.2E+12	N.D.
2000	1.6E+15	1.5E+12	8.4E+06
2001	4.0E+15	2.9E+12	1.3E+07
2002	2.9E+15	2.9E+12	3.1E+07

1) From April to March.

2) N.D. indicates a value less than detection limit. Detection limit of ¹²⁹I is 3.7E-08 Bq/cm³.

3) Including ¹³¹I (¹²⁹I+¹³¹I)

4) Discharge associated with Bitumen fire and explosion incident is not included.

Gaseous discharges

Fiscal Year ¹⁾	Total a (Bq) ²⁾	Total b (Bq) ²⁾	³ H(Bq)	¹²⁹ I(Bq) ²⁾
1979	1.4E+08	5.2E+09	5.9E+13	1.8E+09 ³⁾
1980	2.6E+07	1.4E+09	1.6E+14	1.7E+08 ³⁾
1981	1.3E+07	1.3E+09	1.4E+14	4.1E+07
1982	1.5E+07	1.2E+09	2.0E+14	1.3E+07
1983	1.6E+06	N.D.	5.6E+12	2.8E+06
1984	N.D.	3.6E+07	2.6E+14	8.9E+07
1985	1.1E+07	3.6E+07	2.6E+14	8.9E+07
1986	1.9E+06	4.1E+07	2.4E+14	6.7E+06
1987	1.8E+07	3.7E+07	2.6E+14	2.0E+06
1988	4.1E+05	8.5E+06	7.4E+13	N.D.
1989	1.1E+07	7.6E+06	2.4E+14	1.3E+07
1990	N.D.	2.7E+07	3.6E+14	3.6E+07
1991	1.9E+06	N.D.	3.3E+14	3.0E+07
1992	7.4E+06	N.D.	3.8E+14	6.5E+07
1993	2.8E+05	N.D.	1.6E+14	4.7E+07
1994	4.5E+06	N.D.	4.9E+14	7.0E+07
1995	N.D.	N.D.	2.2E+14	8.4E+07
1996 ⁴⁾	1.7E+06	N.D.	2.4E+14	4.8E+07
1997	N.D.	N.D.	3.6E+12	1.1E+07
1998	N.D.	N.D.	4.9E+11	1.2E+07
1999	N.D.	N.D.	1.4E+12	5.7E+06
2000	N.D.	N.D.	2.1E+13	6.4E+06
2001	N.D.	N.D.	1.3E+14	1.5E+07
2002	N.D.	N.D.	8.0E+13	6.0E+06

1) From April to March.

2) N.D. indicates a value less than detection limit. Detection limit of Total a, Total b, and ¹²⁹I are 1.1E-03, 2.2E-02 and 3.7E-08 Bq/cm³ respectively.

3) Including ¹³¹I (¹²⁹I+¹³¹I)

4) Discharge associated with Bitumen fire and explosion incident is not included.

Liquid discharges

2.5.3 Sellafield, United Kingdom

Figure 12.10. Alpha liquid waste discharges, Sellafield, United Kingdom

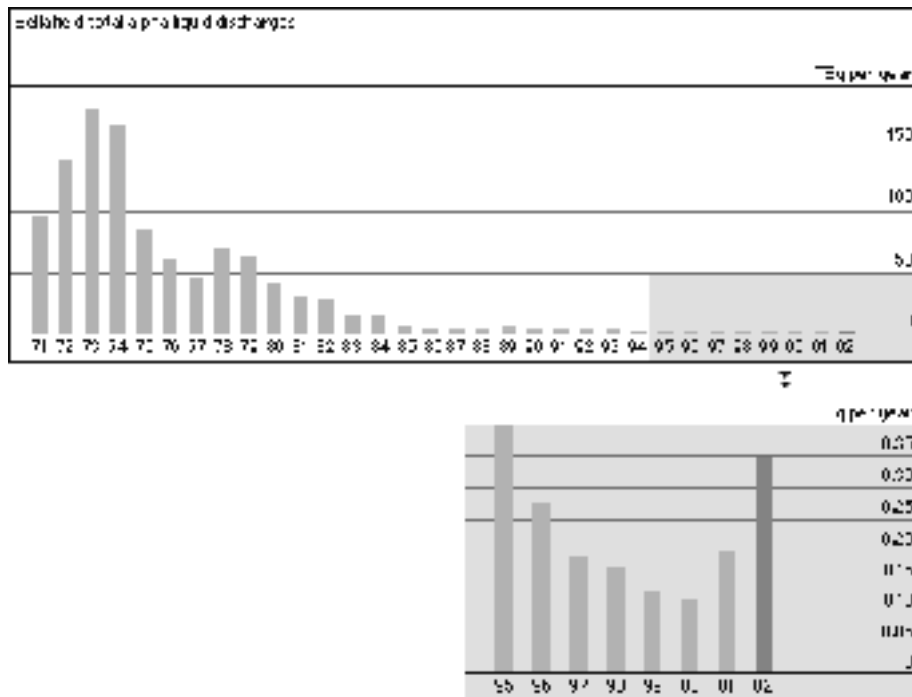
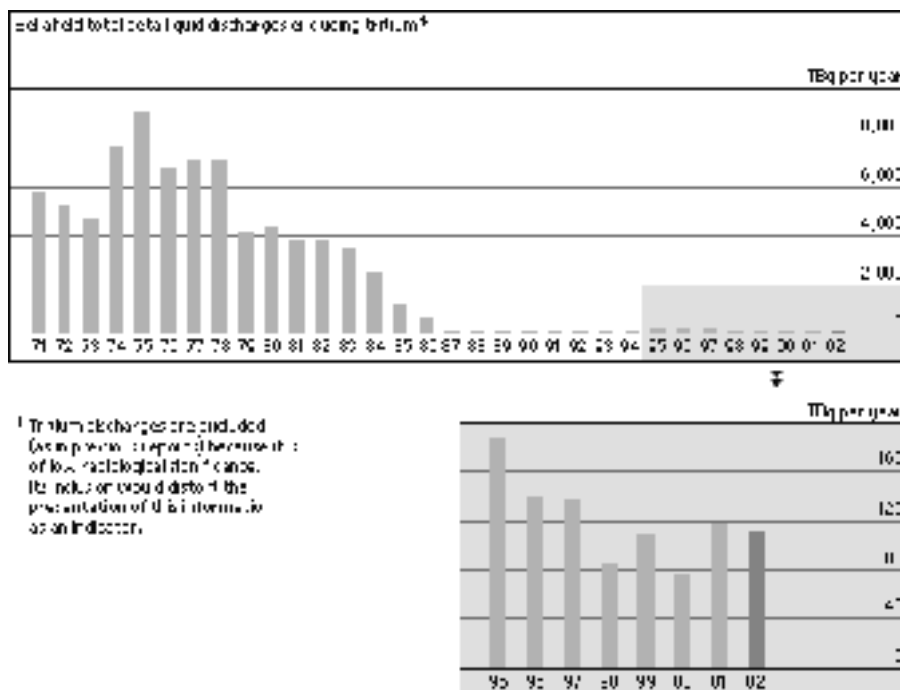

Figure 12.11. Beta liquid waste discharges, Sellafield, United Kingdom



3. Major incidents

As in other areas, incidents and accidents have occurred in the nuclear fuel cycle despite all technical and operational precautions. In all OECD member countries, these abnormal events are reported by the plant operator to the authorities. Care is taken to collect this information in order to improve safety in the facilities and to provide information to the public and scientific bodies. Since minor incidents are reported and collected in most countries, the public might conclude that the nuclear fuel cycle industry is plagued by a never-ending series of incidents. Certainly it has to be admitted that incidents have occurred and will occur in the future, but compared to other industrial sectors, the safety record of all stages of the commercial nuclear fuel cycle is impressively good.

To allow comparison of incidents and to improve information provided to the public, an international severity scale for the evaluation of incidents has been established (INES). However, the following description of major incidents is not based on a systematic evaluation of the severity of their consequences.

It is felt that a description of real incidents of various types is helpful in order to understand the accidental hazards described in previous chapters of this report, even if some are not related to fuel cycle. The incidents can be roughly categorised as follows:

- criticality incidents;
- release of UF₆;
- fire and exothermic reactions;
- leakage of radioactive material, contamination;
- loss of power supply.

3.1 Criticality incidents

Since the inception of the nuclear industry in 1942, nine criticality incidents associated with reprocessing, recovery or fuel plants have been reported throughout the world. This comparatively small number has been due to the extreme care which has been taken in both the design of the nuclear plants and the detailed operational procedures that have been adopted.

Reviews of criticality events have listed seven plant accidents in the United States, one in the United Kingdom and one in Japan. They have been included in this report as examples of accidental situations to indicate the circumstances and mechanisms liable to give rise to a criticality excursion, to assess the magnitude and the consequences of the pulses and to justify the safety measures taken for preventing or limiting the criticality hazards [2,3,4,5]. Incidents are reviewed here in chronological order. It has to be noticed that most of these events occurred in facilities other than proper electrogenerating fuel cycle facility.

3.1.1 *The Y-12 plant, Oak Ridge, 16 June 1958*

The first of the seven plant excursions in the US was the result of solution leaking into a cleaned cylindrical vessel and being collected with leak-test water in a 200 litre drum. As a consequence, five persons were exposed severely and three others significantly.

The accident occurred in an area in which HEU was being recovered from scrap. In the course of a material inventory, a bank of geometrically subcritical storage vessels had been disassembled and

cleaned. Following re-assembly, procedures called for leak-testing with water, which was subsequently drained into a 200 litre drum. In the interval between re-assembly and leak testing, uranium solution had accumulated in the vessels through a valve that was designed to provide isolation from other operating equipment upstream. The water being drained into the drum was preceded by this solution. The initial criticality occurred with about 2.1 kg of ^{235}U in 56 litres of solution. A succession of pulses then produced a total of 1.3×10^{18} fissions (mostly within 2.8 min) before dilution decreased the uranium concentration to a subcritical value. Although the magnitude of the first and largest pulse was not recorded, subsequent excursion experiments suggest a probable value of 6 or 7×10^{16} fissions. An initial “blue flash” was observed and there was no evidence that solution splashed out of the open container.

One person who was about 2 m from the drum at the onset of the excursion received a whole body dose of 3.65 Gy. Other exposures were 3.39 Gy at ~ 5.5 m, 3.27 Gy at ~ 4.9 m, 2.70 Gy at ~ 4.6 m, 2.36 Gy at ~ 6.7 m, 0.685 Gy at ~ 9.4 m, 0.685 Gy at ~ 11 m, and 0.228 Gy at ~ 15.2 m. These exposures and distances from the drum do not correlate in detail because some exposure may have been incurred during evacuation. It appears that the closest man, who left most rapidly, was exposed for about 5 seconds to radiation from the initial pulse. Others, responding to the evacuation alarm, presumably were exposed for about 15 seconds, which is roughly the interval between the first two pulses. It is apparent that exposures were limited by prompt evacuation.

The following corrective measures were adopted subsequently. Instead of relying upon valves for isolating equipment, transfer lines that may contain fissile material are actually disconnected. Only vessels that would be subcritical when containing ^{235}U enriched uranium solutions are permitted.

3.1.2 The Los Alamos Scientific Laboratory, 30 December 1958

The next accident resulted from the concentration of plutonium in a solvent layer which was found in a large tank that was supposed to contain only lean aqueous-organic emulsion. A transient change of shape of the solvent layer when a stirrer was started established a criticality of short duration. The result was a fatality and two other significant exposures.

The accident occurred in an area where residual plutonium, usually about 0.1 gram per litre, and americium were recovered from dilute raffinate. Because the normal plutonium inventory was only 0.1 kg, solvent extraction was conducted in large closed tanks. As at Y-12, a material inventory was in progress and it was intended that the tanks be emptied and cleaned individually. Instead, residues and acidic wash solutions from four vessels were combined in a single 850 litre, 96.5 cm diameter tank; many interconnecting transfer lines made this possible. An excursion of 1.5×10^{17} fissions occurred when a stirrer in this tank was started.

As discussed later, the 20.3 cm thick, 160 litre organic layer floating on the dilute-aqueous solution contained 3.27 kg plutonium. It is presumed that the source of this plutonium was solids that had accumulated gradually in the tanks during the 7.5 years of operations and that the organic layer resulted from separation of the emulsion phases by added acids. The initial effect of the stirrer was to thicken the axial part of the organic layer sufficiently for super-criticality. Continued rapid stirring mixed the two phases, diluting the plutonium to a subcritical concentration.

The operator who was looking into the tank through a sight glass received an exposure of 120 (± 60) Gy and died 36 hours later. Two men who went to the aid of the victim received doses of 1.3 Gy and 0.35 Gy. There was neither damage to equipment nor contamination, although a shock

displaced the tank support 10 mm. A radiation alarm 53 m away was activated and a flash of light was seen from an adjoining room.

The entire recovery plant, which had been scheduled for rebuilding after another six months of operation, was shut down immediately. After ultimate conversion to geometrically subcritical equipment, the following corrective measures were adopted: written procedures and nuclear safety training were improved, unnecessary solution transfer lines were blocked, and auxiliary vessels such as vent tanks and vacuum buffer tanks were “poisoned” with borosilicate glass Raschig rings. Periodic surveys with portable neutron detectors to locate abnormal plutonium deposits were instituted. The accident also led to more complete coverage of process areas by improved gamma-ray sensing radiation alarms.

3.1.3 The Idaho Chemical Processing Plant, 16 October 1959

This facility is now known as Idaho National Environmental and Engineering Laboratory (INEEL). The excursion was the result of inadvertently siphoning highly enriched solution from a bank of geometrically subcritical cylinders into a large waste tank. Although heavy shielding required for irradiated fuel processing protected personnel from direct radiation, fission products vented into working areas resulted in two significant exposures of 0.5 and 0.32 Gy, mostly as beta radiation to the skin.

The siphoning, through a trapped vent system of the waste tank, started as a result of air sparging the storage cylinders. About 200 litres of solution containing 34 kg uranium transferred into about 600 litres of water in the 19 000 litre waste tank. Criticality in this tank led to a total of 4×10^{19} fissions over a period of about 20 minutes. It is postulated that an initial spike of $\sim 10^{17}$ fissions was followed by smaller pulses and then by more or less stable boiling that distilled 400 litres of water into another tank. The exceptionally large yield was the result of the large solution volume and long duration of the reaction, not of the intensity of the excursion.

The incident disclosed the need for improved evacuation procedures and demonstrated the value of radiation alarms in areas that might be affected by an excursion elsewhere. Equipment and operating procedures were modified to establish several lines of defence against inadvertent transfer of fissile material.

3.1.4 The Idaho Chemical Processing Plant, 25 January 1961

This excursion occurred when a large air bubbling forced enriched uranium solution out from the top of a 12.7 cm diameter section of an evaporator and into a 61 cm diameter vapour disengagement column above the normal solution level. The heavy concrete shielding required for irradiated fuel processing protected personnel from direct radiation; the ventilation system prevented airborne activity from entering work areas; and, equipment design excluded the possibility of a destructive or persistent excursion. Nevertheless, this incident is instructive because consequences could have been more serious in an unshielded area.

Apparently, air used to clear a plugged line and to improve operation of two pumps was the source of the bubbling that forced 40 litres of solution containing 8 kg of ^{235}U into the larger diameter section. The resulting excursion, probably a single pulse, had a magnitude of 6×10^{17} fissions. Operation was resumed within an hour.

Because the possibility of an excursion in the vapour disengagement cylinder had been foreseen, there was provision for drainage into a subcritical configuration, which prevented both pressure build-up and a sustained reaction. Although consequences were trivial, the 61 cm diameter cylinder subsequently was “poisoned” by a grid of stainless-steel plates containing 1% natural boron. Steps were also taken to prevent introduction of air into solution lines where the effect could be undesirable.

3.1.5 The Recuplex Plant, Hanford, 7 April 1962

This incident occurred when liquid from a sump was collected in a 69 litre, 45.7 cm diameter vessel. The liquid, unidentified at the time, contained between 1 400 and 1 500 grams of plutonium in a volume of about 46 litres after the addition of lean solutions. The only significant exposures were 0.88 and 0.16 Gy received by personnel at distances of about 2.1, 3.2 and 7 m respectively from the excursion.

The place was a plutonium recovery plant using glove boxes to prevent external contamination. The vessel in which the excursion occurred was normally used for transfer of a dilute stream for solvent extraction columns used in a subsidiary recovery process, similar to the raffinate treatment process of the Los Alamos accident. Apparently the concentrated solution had overflowed from a geometrically subcritical tank and was sucked into the 45.7 cm diameter vessel through a temporary line used for clean-up operations that were still in progress. A total yield of 8.2×10^{17} fissions occurred over 37 hours, with about 20% of the energy released in the first half hour. An initial pulse of approximately 10^{16} fissions was followed by smaller pulses for about 20 minutes, after which boiling occurred, ultimately distilling off enough water to stop the reaction.

The initial pulse, accompanied by the usual blue flash, triggered a radiation alarm, and the area was evacuated promptly, presumably before a second pulse. A unique feature of the analysis of the events was the use of a small, remote-controlled robot developed for handling irradiated fuel. By means of this device, the excursion site was located, meters were positioned and read, and valves were operated.

A new plant to replace Recuplex had been authorised before the accident, and operations were not resumed until it became available. In the modern plant, vessels that are not subcritical by geometry are generally equipped with neutron absorbers. The system is adaptable to a variety of uses without improvisation, and equipment is easier to keep clean. It is recognised that the high level of flexibility needed in this salvage plant requires special effort to maintain realistic, up-to-date written procedures.

3.1.6 Wood River Junction Plant, 24 July 1964

This accident was initiated when concentrated enriched uranium solution was inadvertently drained into a 45.7 cm diameter (75 litres) tank. The first of two excursions resulted in a lethal exposure and the second, about 2 hours later, was primarily responsible for two other significant radiation doses.

Start-up difficulties in this plant for recovering HEU from scrap led to an unusual accumulation of trichloroethane (TCE) solution of low uranium concentration. Small amounts of uranium were recovered by tedious hand agitation of the TCE with sodium carbonate solution. An easier process was improvised, in which the TCE was treated in the 45.7 cm diameter tank that had been intended only for the make-up of sodium carbonate solution used in the normal recovery process. Neither the plant superintendent nor one of three shift supervisors was aware of this practice. Meanwhile, solutions of

unusually high ^{235}U concentration, resulting from clean-out of plugged equipment had been stored in 11 litre, 12.7 cm diameter bottles identical to those that contained the contaminated TCE. Apparently, a bottle of the concentrated solution was mistaken for TCE and was poured into the sodium carbonate solution being stirred in the make-up tank. The shock from a single pulse of $\sim 10^{17}$ fissions knocked the operator onto the floor and splashed part of the solution out of the tank. A flash of light was observed. The victim received an exposure estimated to be 100 Gy and died 49 hours later.

It appears that enough solution was ejected from the tank (the final content of the vessel was 2 kg of uranium in 41 or 42 litres) so that the stirrer vortex was sufficient to maintain subcriticality. Two hours after the first excursion, however, two men entered the area, stopped the stirrer and restarted it some minutes later, after which they drained the tank. These two men received radiation doses between 0.6 and 1 Gy. Evidence of neutron exposure suggested a second less violent excursion while the stirrer was off, which was not detected because the radiation alarm continued to sound after the first excursion. The combined yield of both excursions was 1.3×10^{17} fissions.

Before operation was resumed, there were extensive analyses of the process. These included penetrating reviews and modifications of operating and emergency procedures, criticality limits and controls, uranium accountability and material balance practices, health physics procedures and controls, and training. Geometrically subcritical equipment which had been previously planned for recovering uranium from TCE was put into operation.

3.1.7 Windscale, 24 August 1970

In the United Kingdom, there has been only one such incident since the start of the fuel cycle industry more than 50 years ago. This occurred in a plant used to recover plutonium from miscellaneous residues [6].

The alarm system was activated in the plutonium recovery plant. The building was evacuated promptly. Examination of personal dosimeters of individuals gave no indication of any significant radiation uptake. Checks in the plutonium recovery plant showed radiation levels higher than normal, but certainly lower than those which would have been expected following a criticality excursion.

At the time the alarm sounded, liquor was being transferred from one of the treatment tanks through a transfer pot to the metering reservoir. Measurements of the fission product activity indicated that the incident had occurred in the transfer pot which almost certainly contained the bulk of the fissile material which had been critical and led to the conclusion that the total yield of the excursion was 10^{15} fissions and that it had probably not lasted more than a few seconds.

Explanation of the incident was produced by the analysis of the transfer pot liquor which was unexpectedly found to be a solution of plutonium nitrate in TBP/odourless kerosene solvent. The contents of the transfer pot included 40 litres of solvent with 55 grams per litre plutonium in solution and about 50 litres of 7 M nitric acid with 6 to 7 grams per litre plutonium in solution. It was clear that at the point of criticality the vessel would have contained some 2.5 kg plutonium in the combined 40 litres of solvent and the 50 litres of aqueous solution which was being transferred. The specific gravity of the aqueous liquor was 1.3 g/ml which, considering the geometry of the latter system, was high enough to ensure that the solvent, once having entered the transfer vessel, was locked there permanently. The source of the solvent was not positively identified – recycled aqueous raffinate from the extraction column is one possibility. Experiments and calculations shown that the presence of the emulsion layer produced a more reactive system than that which existed in the quiescent state with the phases separated after flow had ceased. Thus it seems likely that at the cessation of flow, the system

became promptly critical and the shutdown mechanism was the collapse of the interface emulsion layer in about five seconds. The separated quiescent phases were calculated by computer programme to be just subcritical.

A report was produced by the Board of Enquiry making firm recommendations for plant modifications to prevent a recurrence of such an incident. The two most important of these were that neutron monitors should be installed on all vessels which are not safe by geometry and that provision be made to enable the complete emptying of listed vessels.

3.1.8 The Idaho Chemical Processing Plant, 17 October 1978

This incident [4,7] occurred in the first cycle solvent extraction system which was recovering HEU from salvage solutions. A gradual decline in the concentration of aluminium nitrate solution in the aqueous scrub stream feeding column permitted a build-up of uranium concentration in the bottom of the column, to 21 or 22 grams uranium per litre. The mass of uranium in the scrubbing column increased markedly and criticality occurred in the lower part of the column producing an estimated 3×10^{18} total fissions. The criticality occurred in a heavily shielded and suitably ventilated cell. There were no injuries; no release from a breach of containment; and no damage to equipment.

The probable cause of this incident was the failure of the management and review systems to provide for or to prevent the deterioration of administrative controls and alarm instrumentation, though both of which had previously been identified in prescriptions as being required.

3.1.9 JCO Uranium Processing Plant, Tokai mura, 30 September 1999

This event took place in the nuclear fuel conversion building of the JCO uranium processing plant in Tokai. Operations were being undertaken to dissolve uranium powder enriched to 18.8% to a concentration of about 380 gU/l. The government-approved procedure required the operators to dissolve uranium powder with nitric acid in a critically safe mixing tank. The in-house procedure in use, not approved by the regulatory body, authorised the dissolution to be performed in a 10-liter stainless steel bucket before mixing in the safe tank. In violation of the in-house working rules, the operators used a 5-liter stainless steel bucket and a funnel for processing seven batches of uranyl nitrate solution and pour all of them (working unit: about 16.6 kgU) into a precipitation tank when the licensed correct procedure required that no more than one batch of solution (working unit: 2.4 kgU) be in this tank that is not critically safe. As a consequence of these actions, the uranyl nitrate solution in the precipitation tank reached a critical state at around 10:35 a.m. on 30 September. After a peak of intensity, the reaction continued at a lower rate for approximately twenty hours. At around 2:30 a.m. on 1 October, operators began to drain off the coolant running through the jacket pipes installed around the precipitation tank. At 6:15 a.m. on the same day, the reaction stopped. Later, a boric acid solution was poured into the precipitation tank, and the termination of reaction was finally confirmed at 8:50 a.m. on the same day. Based on the results of the analysis of the residual solution in the precipitation tank, the total number of fission produced is estimated at 2.5×10^{18} .

Seven residents, who stayed near JCO fence for several hours after the start of criticality, received a dose (provisional values) ranging from 6.4 mSv to 16 mSv. The radiation doses for the three JCO operators who were operating the dissolution were estimated ranging from 16 to 20 gray equivalent (GyEq), from 6.0 to 10 GyEq and from 1 to 4.5 GyEq, respectively. Two of them died. On the whole, one hundred sixty-nine other employees were exposed to radiation. Twenty-four of them, JCO employees, who performed coolant draining and other operations to stop the criticality, received

doses ranging from 0.7 to 48 mSv. The other employees received doses ranging from 0.06 to 48 mSv. Some of the persons engaged in disaster prevention activities from the Tokai fire station, JNC and JAERI were found to have been exposed to radiation. The doses for these persons were well below 50 mSv. The three Tokai firefighters who had carried the three JCO workers to hospital were found to have received doses of 4.6 to 9.4 mSv.

The direct cause of the event was that workers transferred uranyl nitrate solution containing about 16.6 kg of uranium, which exceeded the critical mass, into the precipitation tank, which was not designed to dissolve this type of solution and was not configured to prevent criticality. On the other hand, many management and administrative type of causes associated with the operational, technical and business management, the licensing procedure, and the safety regulations were pointed out.

The licence of JCO plant was deprived after the incident. The INES rating has been set at level 4 (accident without significant off-site risk).

The government took many measures after this event. The “*Law for the Regulation of Nuclear Source Material, Nuclear Fuel Material and Reactors*” was revised to include many improvements such as requiring nuclear fuel processing licensees to conduct periodic inspections, introducing a system to check licensees’ compliance with their safety preservation rules and the assignment of “Administration of the Nuclear Safety Inspectors” to the major sites, the increase of the number of nuclear inspectors, stipulation of licensees’ duty to train their employees, and the establishment of allegation system. The newly published Special Law on Emergency Preparedness for Nuclear Disaster stipulates that the licensee must prepare an Emergency Action Plan consulting with local authorities, assign an administrator for Nuclear Emergency, and notify relevant Ministers and local authorities of an occurrence of accident. In addition to the existing “Safety Examination Guide for the Uranium Fabrication Facilities”, the “Safety Examination Guide for the Specific Uranium Fabrication Facilities” was newly established for the facilities processing uranium enriched to between 5% to 20% to perform a strict and equitable review of the safety of the facilities, and to prevent the recurrence of such a serious accident.

An adequate radiation shielding has been installed in the plant and necessary corrective measures have been carried out.

3.2 Release of UF_6

3.2.1 UF_6 accidental release in France, 1 July 1977

3.2.1.1 The incident

The incident happened at Pierrelate, France [8], involving a cylinder containing 8 827 kg of liquid UF_6 at around 95°C after a liquid phase sampling operation. The cylinder was resting on a berth, close to the ground next to the sampling building, its valve being at the lowest position. During handling, a mishap occurred and the valve, still connected to the sampling building via a flexible tubing, broke flush with the cylinder wall leaving an opening slightly under one inch diameter: its area was 3.84 cm².

The release of toxic materials took place over almost one hour. Using fire-fighting equipment, 13.5 m³ of water was sprinkled on and around the source over about half an hour. Additionally, 600 kg of liquid carbon dioxide were sprinkled 15 to 20 minutes after the initial burst.

A total of 7 106 kg of UF₆ was released to the atmosphere according to a weighing of the cylinder plugged at the end of the release which showed a residual amount of 1 721 kg UF₆.

3.2.1.2 Data collected

The following three points are worth stressing (note that wind velocity was 10 m/s):

- the amount of uranium detected in the atmosphere was only a small fraction of the UF₆ vaporised;
- hydrogen fluoride from UF₆ hydrolysis could be traced as expected in an area extending 15 km downwind;
- the fluorine to uranium weight ratio in the ground contamination became significantly large beyond 1 000 m.

At the locations where the highest concentrations were detected, chemical dangers were small.

As for the radioactive hazard associated with uranium deposited on the ground, a dose of 1.50 mSv to the kidneys could have been received at a distance of 600 m downwind from the source: but this point lay within the controlled area of plant site.

3.2.1.3 Discussion of data

The flow of liquid UF₆ at 95°C lasted for 11 minutes in the above-mentioned valve opening. The hottest vapour was produced during the initial flash; representing 16% of the total amount released, due to its energy content it was prone to be carried the furthest away from the source.

The amount that evaporated was less than 48% of the amount released, 33% of which was vaporised at the triple point. Thus, the bulk of the amount vaporised was evaporated at a temperature only 8°C above the freezing point at atmospheric pressure (56°C).

Less than 6% of the uranium vaporised could be found in the atmosphere and it may be assumed that the remaining 94% settled near the source. On the other hand, the quantities of HF detected indicate a significant hydrolysis of the UF₆ released. On account of the rate of the release and of the humidity of the air, the quantities found at long distances can only be explained by the deluge of water sprinkled on. It seems from the logbook, that the fire hoses were used early on the source. Their effect must have widely contributed to the hydrolysis of the UF₆ vapour in the air and crystals on the ground. The quantities of uranium analysed in the ground after the incident are in agreement with the above hypothesis.

3.2.2 Incidents in the United Kingdom and the United States

Incidents in the United Kingdom and the United States have been reported in detail at the CSNI Specialist Meeting in Boekelo, the Netherlands [9,10]. Most of them were minor and did not involve injury to personnel.

3.2.3 UF_6 accidental release at Sequoyah Fuels Corporation, Gore, United States, 4 January 1986

At 11.30 a.m. on 4 January 1986, a Model 48Y cylinder filled with uranium hexafluoride (UF_6) ruptured while it was being heated in a steam chest at the Sequoyah Fuels Corporation's Sequoyah Facility near Gore, Oklahoma [11]. One worker died because he inhaled hydrogen fluoride fumes, a reaction product of UF_6 and airborne moisture. Several other workers were injured by the fumes, but none seriously. Much of the facility complex and some off-site areas to the south were contaminated with hydrogen fluoride and a second reaction product, uranyl fluoride (UO_2F_2). The duration of release was approximately 40 minutes.

The cylinder, which had been overfilled, ruptured while it was being heated because of the expansion of UF_6 as it changed from the solid to the liquid phase. The maximum safe capacity for the cylinder is 12.5 t of product. Evidence indicates that it was filled with an amount exceeding this limit.

It has been determined, through interviews and observations, that the cylinder that ultimately ruptured was not properly placed on the scales during its filling. This was due, in large measure, to the fact that the 14-ton cylinder being filled was longer than the 10-ton cylinder for which the equipment was originally designed. This caused the cart on which the cylinder rested to be positioned very close to the edge of the scales platform. Because of the misalignment of the cylinder and the cart, one wheel of the cart supporting the cylinder was off the platform and was resting on the floor. This caused erroneously low readings on the scale during filling.

When the operator noted that he was unable to add more UF_6 to the cylinder, he investigated and discovered that the wheel was off the platform. After the cart and cylinder were repositioned, the scales were unable to record the actual weight of the cylinder because the weight exceeded the dial indicator range. The cylinder at this point weighted more than 13.4 t, the limit of the dial indicator. Later estimates placed the weight in excess of 14 t; the fill specification for this cylinder is 12.5 t. The operator adjusted the tare-compensating mechanism on the scales to permit observation of weight loss while he attempted to evacuate the excess material by vacuum back into the cold traps. This evacuation attempt is in accordance with procedures and accepted practice.

On the subsequent shift the next operator concluded that the material was no longer being evacuated, presumably because the contents of the cylinder had cooled and solidified. The operator and the assistant shift-supervisor moved the cylinder to a steam chest for the purpose of heating the cylinder to liquefy the contents and facilitate later evacuation. The weight of the contents at this point is not known, but the cylinder definitely contained more than the fill specification of 12.5 t. In any case, the cylinder was definitely overfilled. Sequoyah Fuels Corporation operating procedures prohibit the heating of an overfilled cylinder. Placing the overfilled cylinder in the steam chest for heating was clearly a violation of these procedures.

Approximately two hours after heating began, the cylinder ruptured in the steam chest. A 1.2 m lengthwise rupture occurred along the top of the cylinder.

The force of the explosion damaged the steam chest enclosure. The escaping UF_6 rapidly reacted with moisture in the air to form uranyl fluoride and hydrogen fluoride. The resulting vapour cloud of these materials was carried south by southeast by a wind gusting to 40 km/h. The cloud enveloped the process building, and the acidic vapour caused the death of an operator who was working approximately 21 m away from the cylinder. The vapour was drawn into the plant ventilation system. Approximately 40 workers in the building evacuated to an upwind location on site, some passing through the cloud.

The injured workers were transported by fellow workers to nearby hospitals for treatment. The general population downwind was contacted and advised to evacuate and report to hospitals for examination.

The following factors were identified as the primary contributors to the accident:

- The cylinder was overfilled because it was not placed fully on the scales. The fill bay and associated equipment were not designed to prevent improper positioning of cylinders in the bay so that the cylinder would not be on the scales. The fill bay was not designed to accommodate 14-ton cylinders.
- The time required for filling the cylinder was long enough to allow partial solidification of the UF₆ which inhibited product removal from the cylinder.
- The precise weight of the cylinder was not readily determinable after it was overfilled.
- There was no secondary or alternative way to measure the quantity of material in a cylinder being filled.
- Employees violated company procedures when they heated an overfilled cylinder. Workers, including line-management personnel, had not been trained in regard to company procedures. Procedural controls such as checklists or approval points were not an integral part of plant operations.
- Equipment for monitoring or automatically venting cylinders that are being treated was not provided for by the plant design.

3.3 *Fire and exothermic reactions*

3.3.1 *Accident in the Southern Urals, 29 September 1957*

In order to give a complete survey on the safety aspects related to HLLW storage, a very short account is given below of an explosion which took place on 29 September 1957 at Kyshtym in the Southern Urals region (the former U.S.S.R.). The accident occurred with a type of solution which does not appear in any western type PUREX flow sheet and happened during the pioneering period of 1945-57 of Soviet military development. The facilities as described did not comply with western standards and the solutions are not representative of western type HLLW. The tank was filled with a highly active solution of HNO₃-Na acetate and stored from 1949 until 1957. By accidental interruption of the forced cooling for a prolonged period, the temperature rose until 350°C when the mixture exploded.

About 74 PBq (2 MCi) of fission products were released to the atmosphere (compared to 1.85 EBq (50 MCi) during the Chernobyl accident) over a distance ranging from 100 to 300 km with a perpendicular plume width of 8 to 9 km. The central heavily contaminated zone of 1 120 km² showed a concentration level of 74 GBq/km² to 3.7 TBq/km². The external gamma dose to persons directly exposed amounted to a range of 7 to 170 mSv and an effective dose, including uptake by ingestion of 23 to 520 mSv.

By deep ploughing (~ 50 cm) the radioactivity level at the surface was gradually reduced to lower levels. No increased mortality rates were observed in comparison with the existing local rates.

3.3.2 Incident in plutonium processing facility at Hanford, 6 November 1963

3.3.2.1 Description of the incident

At approximately 1:23 a.m. on 6 November 1963, a sudden reversal of air flow was noted in the ²³³S building [12]. The event was accompanied by a detectable vibration of the instrument panel board, as air from the process area was forced into the operating gallery. Immediately the operation in the ²³³S facility was shut down by remote control. Approximately 30 minutes after the first event, radiation monitors investigating the incident noted the presence of a fire. It was not considered advisable by the operators to use water in combating the fire, unless absolutely necessary, because criticality control was a consideration in the system. Only dry-chemical extinguishers (sodium bicarbonate) were permitted in combating the fire. The fire was extinguished in 1½ hours by the use of approximately 225 kg of sodium bicarbonate. It was estimated later that if water fog had been used, the fire could have been extinguished in five minutes.

The fire progressed through open floor gratings to involve all four floors of the facility and the anion exchange contactor enclosure. This enclosure consisted in part of rigid plastic panels, stainless-steel panels, plastic gloves, and other plastic units. Also involved in the fire were clothes hampers and contaminated laundry and waste materials located in the viewing room adjacent to the process area. As a consequence of the fire, alpha contamination was widely spread throughout the building.

Because of fire damage to the building and equipment, and because of the alpha contamination and the cleanup required, plus normal maintenance, the Redox plant was shut down for approximately six weeks. Operation was resumed without the use of the anion exchange contactor and will continue indefinitely in this manner.

3.3.2.2 Analysis of evidence and findings

➤ Examination of the anion exchange contactor

Examination of the contactor revealed that the stainless steel section in the lower portion of the contactor showed a uniform pipe diameter expansion caused by internal pressures. The expansion involved an increase in diameter from a nominal 11.4 cm outside diameter to 12.4 cm outside diameter, with a decrease in wall thickness. The schedule-40 pipe components showed no significant enlargement.

One flange gasket in the main column above the feed tee was missing completely, and a pair of Teflon gaskets on the XAW tee connection was ruptured. Screens and screen supports in two lines in the lower section of the contactor were ruptured or distorted, and three screens from widely different portions of the contactor showed discoloration, indicating exposure to high temperature. There was no evidence of any pipe rupture or pressurisation of any other section of the ion exchange loop. Instrument records support the contention that the elapsed time from the beginning of the pressure increase to the final pressure release was less than one minute.

➤ Analysis of the anion exchange resin and contactor feed solution

An inventory of the resin after the incident established that approximately one half of the resin remained in the column. A considerable quantity of resin was recovered from the floor of the main process area. The distribution of the resin was in a generally circular pattern of 2.4 to 3 meters radius, centring on the ion-exchange contactor.

Examination of resin samples removed from the column and the floor showed that approximately 40% of the resin was degraded and possessed a sticky, gelatinous texture. Resin in the vicinity of the feed tee was found to contain dichromate, and nearly every resin sample showed the presence of chromium.

A liquid sample withdrawn from the feed tank for the anion exchange contactor showed the presence of 4.9 grams per litre of Cr^{3+} and 1.7 grams per litre of Cr^{6+} . The solution also contained 16 grams per litre of plutonium, of which 15.2 grams per litre was in the +6 valence state.

➤ Interpretation of evidence

Pressurisation of the anion exchange contactor is believed to have been caused by chemical degradation and oxidation of the plutonium-loaded anion exchange resin. It is suggested that the degradation of the resin may have been triggered by the inadvertent addition of sodium dichromate to the system, and it is estimated that 1 to 2 hours of exposure to dichromate at 85°C would have been sufficient to produce the kind of resin degradation observed in samples after the incident.

Evidently the prolonged period of high plutonium loss to the XQW waste was directly related to the presence of dichromate to the system.

3.3.2.3 Ignition behaviour of anion exchange resins

Radiation damage of the resin was found to be serious only when exposure levels exceeded 3×10^6 Sv. Since the plutonium-loaded resin in process application received an exposure dose equivalent to 6×10^5 Sv per month, the projected useful life of the resin should be around five months. On the basis of these results, it was concluded that anion exchange resins such as Permutit SK and Dowex I-X4 were sufficiently stable to both chemical and radiolytic attack under the conditions that would be encountered in normal column operation to permit their use in a production facility. Accordingly, several anion exchange systems were set up at various facilities and operated without incident for several years. However, during 1963, two accidents occurred in the United States which indicated that anion exchange resin in plutonium service might not be as stable as previously stated. The first incident reported involved the pressurisation followed by the rupture of a gasket and discharge of column contents of a batch anion exchange column at the US Atomic Energy Commission plant at Rocky Flats in July, 1963. As a result, an experimental programme has been started at Hanford to re-evaluate the hazards associated with the use of anion exchange resins in plutonium service. An accident involving the rupture of a laboratory anion exchange column occurred in France in 1962.

3.3.2.4 Significance of the incident

The extent of fire damage and the spread of contamination probably could have been reduced considerably by the use of water for fire fighting. The consensus of the investigating committee was that a prior evaluation of relative risks would have established that reasonable amounts of water fog could have been used for fire fighting with negligible likelihood of criticality, particularly in areas adjacent to the processing equipment. It was recommended that criteria and guides be established which would assist firemen and operating personnel in assessing the degree of criticality risk in the use of water on fires in facilities handling fissile materials.

The most significant fact evident from the incident was the realisation that the maximum safe operating temperature for plutonium anion exchange systems is substantially lower than previously thought. Important findings are:

- plutonium loading markedly lowers the ignition temperature of the resin;
- resin flooded with liquid is capable of violent decomposition;
- resin ignition temperature appears to decrease with an increase in column diameter.

The maximum safe operating temperature has not been defined, but it may be as low as 80 to 90°C. Hanford has specified a maximum operating temperature of 70°C for such systems until safe limits can be better defined. No injuries, radiation or otherwise, resulted from the incident.

3.3.3 *The incident in the head end building at the Windscale Works, 26 September 1973*

On 26 September, 1973, a release of airborne radioactivity occurred in the head end Treatment Plant of the Windscale Works [13]. Thirty-five people who were in the building at the time were found to have external contamination and contamination of the lungs, mainly from ^{106}Ru .

The existing facilities in the original separation plant were modified to provide a head end initial treatment process for oxide fuels prior to feeding the product liquor to the operational reprocessing plant. The modifications were completed and the B204 head end plant fully commissioned in August 1969. This incident occurred just as a processing campaign was being started.

Investigations into the incident were started by the Nuclear Installations Inspectorate (NII) within 24 hours of the occurrence and included examination of the cause of the incident, the protection of personnel and the consequences of the incident. The company also conducted an inquiry and provided all the technical data to the NII. On the balance of evidence, some tentative conclusions may be reached on the mechanisms which could have led to the escape of ^{106}Ru into the B204 working area:

- Exothermic reactions took place in a constant volume feeder CVF 111 between high-temperature insoluble fission products containing large quantities of ^{106}Ru , zirconium fines and other solids and the acidified Butex solvent (β -dibutoxy-diethyl-ether) leading to the decomposition of the butex and, possibly, ignition of the zirconium.
- The gas resulting from the reactions pressurised the constant volume feeder and escaped through the cell wall to the working zone along the shaft connecting the constant volume feeder to its drive motor and/or an instrument trough. Normal circulation of air rapidly transferred the gas to all the upper floors of the building.

Air samples taken from the plant stack indicated that a release of ^{106}Ru to atmosphere of about 370 GBq (10 Ci) had occurred. This was equivalent to less than one fifth of the then appropriate daily derived working limit (DWL) for the stack. No airborne activity was detected above background levels downwind at the site boundary or beyond.

Air samples taken in the working area at the time of the incident indicated significant levels of airborne activity; the highest levels were approximately 100 times the maximum permissible concentration in air for active areas recommended by ICRP.

The seventh floor was found to have the highest levels of surface contamination. In the plant operating area adjacent to the penetration housing the shaft of constant volume feeder and the

instrument trough, the surface contamination levels were greatly in excess of the DWL for surface contamination in active areas.

All 35 persons in the head end building at the time of the incident were contaminated on the body. The external contamination produced no adverse health effects. The amounts inhaled have been measured on a whole body monitor for all 35 men. One man was estimated to have up to about 1.5 MBq in his lungs, the others to have amounts ranging from 0.35 kBq to 185 kBq. The man with the highest incorporation had an estimated dose commitment in 50 years of approximately 10 Sv. The men in the next most highly irradiated group (four men) had estimated dose commitments ranging from 0.15 to 0.3 Sv and the remaining men had estimated dose commitments of up to 0.15 Sv. No adverse medical effects have been observed to date as a result of the internal exposures.

Proposals were made to reduce the likelihood of a recurrence of butex/solids reactions entailing monitoring the arising of solids in irradiated oxide fuel reprocessing and removal of such solids in plant process vessels. Recommendations were made for improving the protection of operators in B204 and especially on:

- The sealing arrangements for penetration between the working area and the cell.
- The ventilation arrangements which led to the escape of radioactive materials from the processing cells.
- The beta-in-air monitors which did not appear to be adequate in type and number to give unambiguous warning of high airborne contamination levels.
- The emergency arrangements which did not deal adequately with the situation. The lack of suitable emergency arrangements was evidently due to the fact that there had been no similar incident on the site, or, as far as is known, anywhere else.

For a variety of reasons the head end plant was not operated again.

3.3.4 Explosion and fire during conversion of liquid uranyl nitrate to solid uranium oxide at the Savannah River Plant, the United States, 12 February 1975

After 20 years of operation without a major incident, an uncontrolled reaction occurred when TBP uranyl nitrate (accidentally added to a denitrator) thermally decomposed [14,15]. The reaction forcibly ejected much of the denitrator contents. The room was filled with red-brown NO₂ fumes and with combustible gases from the decomposition of the TBP. The gases ignited and caused an explosion and fire that resulted in minor injury to two employees (both returned to work the same day after being examined by plant medical personnel). Damage to the building and equipment were also minor in nature.

As the operators approached the exits, the explosion occurred, pushing both men through the doors. One operator had a mild irritation of the lungs due to inhalation of acid fumes. There were no cases of skin or nasal contamination or of uranium assimilation. Measurements showed that contamination was confined within the building-area fence.

Although one wall was damaged, no damage was done to the structural support of the building. The walls, the room ventilation system, insulation, lighting and painting were the major items in need of repair. Fire damage was confined to the processing room. Clean-up of the floor, overhead piping, denitrators, etc. was required before normal operations were resumed in August 1975.

The main conclusions, as derived from analyses of residues and review of production records, and observation of the incident are the following:

A denitrator containing ~ 1 175 kg of $\text{UO}_2(\text{NO}_3)_2 \cdot 6\text{H}_2\text{O}$ and ~ 190 kg of $\text{UO}_2(\text{NO}_3)_2 (\text{TBP})_2$, was heated more slowly than usual. At the same time the denitrator skin temperature controls were rising from 250 to 400°C; the estimated decomposition of the $\text{UO}_2(\text{NO}_3)_2 (\text{TBP})_2$ began at ~ 170°C. The gases released were NO, N_2O , NO_2 , H_2O , butane, butanol and possibly BuNO_x ($x = 1, 2$ or 3 compounds). The estimated gas release was about 500 m³ at STP, at an estimated maximum rate of about 18 m³ per second at STP. This rapid release of gases ejected the denitrator contents into the room. The gases collected under the ceiling ignited and generated a pressure that blew out the walls (the over-pressure necessary to cause the damage observed is less than 0.5 bar).

A reasonable estimate of the energy release is about 2.93×10^6 J (7×10^5 kcal). The calculated conditions responsible for the shock wave are a temperature of 4 650 to 4 750 K and a pressure of 31 to 40 bar. The calculated temperatures are adequate to form the pumice-like material deposited on structural members and equipment and the calculated pressure wave is adequate to blow out the walls. The overall energy release would classify this as a low-grade explosion.

The specific source of ignition was not determined. However, the free radical reactions in the gas phase were the most probable source.

As a result of the incident, a number of process changes were made to prevent a recurrence:

- All tanks downstream of the first evaporator are agitated continuously to prevent stratification of aqueous and organic layers.
- Analyses for organics in the aqueous phase are required for all solutions before transfer through the system. Operating limits for the organics have been set to prevent an unsafe quantity from reaching the hydrate evaporators and denitrators.
- The heating rate has been lowered so that any organic reacting in the denitrators would, upon decomposition, evolve gas at a relatively low rate.
- The air flow through the denitrator off-gas has been increased to ensure that any evolved organic vapour has a concentration below its explosive limit.
- New process instrumentation has been installed to determine whether or not the new limitations on denitration conditions are being met. The new instrumentation also provides for a more rapid response to violations of critical controls, either manually (following an alarm) or automatically.

3.3.5 Explosion of an off-gas scrubber in the scrap recovery at the Siemens uranium fuel element fabrication, Hanau, Germany, 12 December 1990

On 12 December 1990, at the fuel fabrication plant for uranium fuel elements in Hanau, Germany, an explosion occurred in a scrubber [16]. The spray scrubber for off-gas cleaning was part of the installations for uranium recycling and treatment of liquid waste streams.

The lower part of the scrubber column built of steel was ripped and demolished, the bottom was thrown down and the upper part built of PVC was broken into many pieces; also bolts and flanges were torn. The housing of the loop pump was smashed into small missiles. The adjacent storage tanks,

pipings and switch cabinets were deformed by the pressure wave. Some storage tanks were penetrated by missiles and also the roof of the hall got some small holes.

From the destroyed or damaged storage tanks about 800 kg LEU leaked to the floor mainly as a solution. The liquids containing uranium were kept within the provided sections at the floor of the hall. The off-gas filtering system was not affected. No radiation or emission of radioactivity to the environment occurred. Two workers were injured, one of them severely.

3.3.5.1 Investigation of the incident causes

The scrubber had to treat the off-gas of several systems:

- dissolvers, for recycling of uranium oxide, delivering mainly nitrous gases;
- furnaces, for calcination of ADU filter cake and for drying clarification mud, delivering ammonia and also organic carbon and fluoride;
- some storage and precipitation tanks, and other components also delivering ammonia.

So in normal operating conditions in the scrubber pool there was present an ammonium nitrate solution with parts of ammonium nitrite, fluoride and organic compounds.

Due to a failure of the liquid level control, the ammonium nitrate concentration in the scrubber liquid increased because of evaporation of the water into the off-gas. Probably the formation of slurry, or crystallisation, occurred in consequence. Obviously the explosion was initiated by the loop pump running at a too high temperature. The rapid thermal decomposition of ammonium nitrate destroyed the pump and struck back to the sump of the scrubber where an explosion also took place and the remaining scrubber pool liquid was thrown upwards.

The typical residue samples taken from several places in the scrubber wreck and in the loop contained ammonium nitrate up to 50% (weight) and about 10% fluoride as well as about 1% nitrite. The values in the solution and in the slurry were certainly lower. The nitrite might have stimulated the starting reaction because of the lower decomposition temperature. The fluoride and the uranium content as well as the organic compounds might have had a catalytic effect.

3.3.5.2 Improvements and corrective actions

In order to avoid similar incidents in all systems where ammonium nitrate is handled, or could be formed, some corrective actions will take place:

- the off-gas of the dissolvers and the calcining furnaces or other liquid waste treatment systems will be cleaned in separated scrubbers;
- the scrubber has to be operated in a way that the formation of ammonium nitrate be negligible;
- the liquid level control in the scrubbers has to be improved so that undetected concentration cannot occur;
- the pump control of systems with ammonium nitrate solution has to guarantee that no “dead-headed” pumps could cause local concentration increases.

3.3.6 TNX evaporator incident at the Savannah River Plant, 12 January 1953

On 12 January 1953, while concentrating a uranium nitrate acid solution, an intermediate evaporator was destroyed by an explosion. Two minor injuries to personnel also resulted.

At the time of the incident, a special series of evaporations was in progress to remove about 50% of the nitric acid from 6 840 litres of uranium nitrate (UN) solution. Equipment size necessitated that deacidification be carried out in several batches of approximately 1 900 litres and three batches had been successfully processed. The fourth and final charge consisted of the 265 litres heel of the original solution plus 600 litres of previously evaporated material which had been diluted with water. The additional 600 litres were required to make a minimum evaporator charge. Because the liquid temperature recorder was broken and since the required degree of concentration was beyond the range of the specific gravity recorder, the evaporation was being carried out for a specified length of time based on past experience. Five minutes prior to the scheduled completion of this fourth evaporation, a violent reaction took place with sufficient pressure to destroy the evaporator and cause extensive damage to the building.

The later investigation demonstrated that this incident appeared to be the result of the following series of events:

- presence of TBP (about 36 kg) in the aqueous uranyl nitrate solution;
- concentration of the solution to greater than 78% uranyl nitrate/total aqueous at temperature greater than 130°C;
- build-up of a 3.6 to 7 bars back pressure due to partially plugged bubble trays.

This incident and the investigation subsequently led to establishing operating limits on organic concentrations and on temperature for evaporators at the Savannah River Plant.

3.3.7 Bitumen fire and explosion at Tokai Reprocessing Plant, 11 March 1997

At 10:06, 11 March 1997, fire started from the drums which were filled with bituminised waste at the filling room of bituminisation demonstration facility (BDF) in Tokai Reprocessing Plant (TRP) of PNC (reorganised to JNC now). The BDF had produced about 30 000 drums of bituminized low-level radioactive liquid waste from TRP since 1982.

The sequence of the event is as follows. At 10:06, an operator observed a flash in the filling room and a 2 m high flame on a drum. At 10:12, the other operator started to extinguish the fire using the installed water spray. After about one minute, the operator stopped the water spray since he didn't see the fire in the cell any more. At 10:23, all the ventilation blowers, except the vessel ventilation blower, stopped. At 20:04, an explosion occurred. Flue gases escaped from the windows of the building for about 3 hours. The radioactivity released from the BDF was assessed based on the environmental monitoring and the migration behaviour from the fired drum through the building. The released radioactivity was estimated to be from 1 to 4 GBq for the beta nuclides (except ^{14}C) mainly ^{137}Cs , and from 6×10^{-4} to 9×10^{-3} GBq for the alpha nuclides mainly $^{238, 239, 240}\text{Pu}$ and ^{241}Am . The maximum committed dose equivalent for the public due to the released radioactivity was evaluated to be from 1×10^{-3} to 2×10^{-2} mSv.

The main content of the liquid waste was NaNO_3 . After the liquid waste and bitumen were mixed and dehydrated in the extruder, the mixture was filled to drums. Shortly before the event, the

feed rate of the liquid waste to the extruder was decreased to a much lower rate than usual. Many presumptions were investigated linked to this decrease of feed rate. It was concluded that the main cause of fire had been physical heating because of the excessive accumulation and the enrichment of salt inside the extruder, itself caused by the low feed rate. This mechanism made temperature of bituminised product rise. The temperature of bituminised product filled in drums gradually raised up to initiate runaway reaction between sodium nitrate/nitrite and bitumen and led to self-ignition. Insufficient spray of water caused the release of flammable gases from heated bituminised product into a low oxygen atmosphere. The flammable gases could not be vented due to clogging of the filters. The vessel ventilation system, still working, supplied air gradually and premixed gases were ignited by another self-ignition. The immediate cause was the decrease of feed rate, which proves the importance of understanding equipment's behaviour in many possible conditions. Chemical heating was not recognised as the cause of this incident, but the chemical reactivity of the bituminized product should be well understood and controlled.

The INES rating has been set at level 3 (Serious incident).

The BDF was shut down after this event and the treatment of the low-level radioactive liquid waste replaced by the LWTF process described in Section 8-5.1.

The impact due to the radioactivity released through the incident was not significant. However, the incident had a societal impact, which led to the safety evaluation of TRP by PNC. This activity took almost one year and included the evaluation of the incident prevention and mitigation system, and the review of design data for criticality safety, shielding. The radioactive inventory of various part of the plant (shear feed, dissolver, vessels and processes etc., into sludge, wastes, products, concentrated liquids and recovered liquids, etc.) was reassessed using the DF or the transfer rate of the elements based on experimental data and/or conservative assumptions [17]. In the evaluation, all potential hazards and supposed accidents were extracted applying HAZOP and FMEA, safety design of each process was evaluated, and the TRP's safety was confirmed with several improvements of equipment and revision of operation manuals.

3.3.8 *Fire at Portsmouth gaseous diffusion plant, 9 December 1998*

3.3.8.1 Date and place

On 9 December 1998, Portsmouth Gaseous Diffusion Plant, operated by Lockheed Martin Utility Services for the USEC, located about 3.2 kilometres east of Piketon, Ohio.

3.3.8.2 Nature and probable consequences

The staff observed a series of abnormal conditions associated with the side purge cascade, Cell 25-7-2. The staff's immediate response to the abnormal conditions was not successful in restoring normal operations and an exothermic reaction was either started or propagated within the cascade. The exothermic reaction continued until sufficient heat was generated to cause a failure of the Cell 25-7-2 cooling system, initiating a second exothermic reaction. Subsequent heat and pressure increases within the side purge cascade resulted in:

- the creation of holes within the process gas cascade boundary of Cell 25-7-2;
- an automatic shutdown of the side purge cascade;

- the activation of a portion of the Building X-326 automatic fire suppression sprinkler system;
- an emergency response and approximately 2 hours of fire-fighting activities by the onsite fire department;
- challenges to the continued operation of the remainder of the process gas cascade.

A photograph of the damaged cell is shown in Figure 5.5.

The radiological and chemical consequences of the event on plant staff were minor and well within applicable NRC requirements. The general public experienced no measurable radiological or chemical consequences from this event.

3.3.8.3 Cause or causes

The extensive fire damage experienced by Cell 25-7-2 equipment has made it difficult to determine the root cause. Much of the equipment has been damaged to such an extent that evidence needed to determine the root cause was destroyed. The investigation by the operator identified two possible initiating events: a physical failure of the compressor impeller or a chemical deposit caused by wet air leakage into the equipment. In either event, mechanical friction within the process gas cascade equipment generated a sufficient amount of sustained heat to begin an exothermic reaction between the aluminium compressor components and the process gas (uranium hexafluoride). On the basis of a review of some of the Cell 25-7-2 components removed since the fire, the exothermic reaction was believed to have been initiated in the Stage 2 compressor and propagated through the cell equipment to the Stage 4 compressor. In the Stage 4 compressor, the reaction was thought to have been intensified by the input gases, received from the remainder of the cascade, resulting in increasing internal process gas cascade temperatures until there was a failure in the Freon coolant system boundary. Elevated pressure, caused by the introduction of Freon from the coolant system and a second exothermic reaction between the hot metal and Freon, was thought to be the final event that occurred before the holes were burned in the process gas cascade boundary.

3.3.8.4 Actions taken to prevent recurrence

Initial compensatory and corrective measures implemented by the plant staff as a result of the fire included:

- administrative controls to preclude a restart of the side purge cascade and some other plant operations pending the completion of a root cause evaluation for the fire;
- immediate manual vibration monitoring of other centrifugal compressors to search for other unstable equipment;
- covering of openings created in the process gas piping and equipment of Cell 25-7-2 as a result of the fire;
- development of a revised nuclear criticality safety basis for Cell 25-7-2;
- interim training of cascade operators and managers on the lessons learned about operations from the event;
- interim training of fire-fighters and management on the safety risks of and the proper fire fighting techniques for a fire concurrent with holes in process gas cascade equipment.

The long-term corrective actions include the following: adding process gas temperature monitoring, adding an alarm and automatic shutdowns on the side purge compressors for compressor high-process gas temperature, improving the process for evaluating and responding to cascade component vibrations, and completing procedures for operator response to other precursors to a hot metal reaction.

3.4 *Leakage of radioactive material, contamination*

3.4.1 *Incident in the pool water treatment plant at La Hague, 2 September 1977*

The incident happened during a filter declogging operation on a twin filtration circuit in the storage pool water treatment plant at La Hague [18]. A high water stream from a badly closed bypass circuit tap flowed into the declogging effluent tank. This tank was quickly filled to overflowing before any emergency intervention could be made.

This incident, caused by a defective valve, resulted in a high contamination of the soil. The maximum dose rate was 0.01 Gy/h at one meter from the soil.

Preventive measures taken after the incident included checking of all stopcocks and the installation of control systems automatically closing the draincocks when the filter effluents reach the upper level in the tank.

3.4.2 *Incident in the plutonium conditioning and storage plant at La Hague, 26 November 1977*

On 26 November 1977 a contamination incident occurred in a plutonium conditioning and storage plant at La Hague [18]. Bellows of a manipulator became disconnected from the opening ring of one of the two twin boxes used for plutonium dioxide conditioning. This incident resulted in a rapid air intake in the glove boxes, so that for a few seconds there was no negative pressure in the glove boxes. The pressure regulation system was too slow to prevent this increase of pressure. An overpressure was even temporarily found in one of the two boxes. An unsuspected leakage of one box thus caused an air contamination of 2 000 MPC-h (Maximum Permissible Concentration) in the room. Nobody was involved in this incident.

Following this incident a research and development programme was set up to:

- improve the quality of the elastomer constituting the bellows of the manipulator and the mechanical and thermal protection of these bellows;
- decrease the inertia of the pressure regulation system to improve the response to any sudden pressure variation.

3.4.3 *Incidents in the HAO Building at the La Hague spent fuel reprocessing plant, 1978*

At the La Hague fuel reprocessing plant, two other incidents have been reported, both occurring at the high activity oxide (HAO) building [18].

The first incident happened on 3 February 1978 in the area of a sampling circuit associated with a high radioactive process tank. This circuit comprises an air lift system which lifts the solution from the tank to a pot where samples are taken from before being sent to the laboratory. The lower end of

the air lift tube should always be kept immersed in a dead volume of liquid at the bottom of the tank. The air lift system was accidentally left in service, and the dead volume was emptied; the air flow generated by the air lift system carried radioactive aerosols in the upper circuit through the reflux column and the filter.

The consequences were high contamination of the off-gas circuit, normally protected by the reflux column and the filter, resulting in high contact radiation but, fortunately, in low dose exposure of the personnel. The causes of this incident could probably be attributed to design and/or construction defects which allowed the liquid to drop below the level of the air lift pipe and to a lack of co-ordination between the laboratory staff and the plant operators during sampling. Preventive measures taken after this incident included a review of the operating instructions concerning the air lift systems.

The second incident happened on 10 May 1978. This was a leakage from lead-shielded valves on the liquid effluent line from the spent metal fuel chemical decladding plant. For unknown reasons the alarm connected to the effluent leak gauge did not work. About 2 m³ of active liquid leaked through the shielding and spread over the cell floor. Another radiation detector gave the alarm late.

The cause of leakage was attributed to loose valve flanges; thus a remote tightening was performed, but a very careful decontamination operation was necessary. Improvement of this part of the equipment is planned, which will include a simplified network and a reduction in the number of valves.

3.4.4 Leakage of radioactive liquor into the ground at Sellafield, 15 March 1979

Unexpected radioactive contamination was discovered during a hydro-geological survey, commenced by BNFL in 1978, to investigate the water table beneath the site following a leak from the B38 silo. A report on that leak was published in February 1980 [19]. Analysis of water samples revealed the presence of short-lived fission products below ground which indicated that a recent leak of radioactive liquor had occurred.

Additional measurements in a pattern of new boreholes confirmed that building B701 was the source of the contamination, and video-camera examination showed liquid up to 10-15 cm from the top of the metal cladding in the bottom of this building.

The investigation has revealed that, with the diverters correctly set to other destinations, radioactive liquor could splash-over into the Export Plant decay tank. This tank then overflowed into the sump vessel. Because operating instructions for emptying the sump vessel, which included a requirement to monitor the level in the sump, were not complied with, the radioactive liquor eventually filled the sump vessel and overflowed into the metal clad area in the bottom of building B701.

The radioactive liquor then escaped through defects in the metal cladding and finally leaked into the ground at about the foundation level of the building, four meters below the surface. It is estimated that more than 3.7 PBq (100 000 Ci) of radioactivity escaped over a period of some years.

The result of the leak is that a layer of soil, about one meter thick at a minimum depth of about three meters, is contaminated. The maximum radiation level, measured using probe tubes driven into the ground, was nearly 6 Gy per hour at a depth of four to five meters. Nevertheless the over-cover of uncontaminated soil means that radiation is not significant at the ground surface and that therefore there is no hazard to workers or members of the public.

3.4.5 Contamination of beaches at Sellafield, 10 November 1983

The reprocessing plant, building B205, was shut down on 30 October 1983 for routine annual maintenance [20]. This involved, among other things, the emptying and washing out of the plant in accordance with written operating instructions. The resulting liquors were collected in a number of plant wash tanks pending transfer to tanks in other buildings depending upon the radioactivity of their contents.

On 10 November, one of the B205 plant wash tanks, the Highly Active Plant Wash B (HAPWB) tank, contained radioactive aqueous liquor with lighter radioactive solvent floating on top of it and with a layer of highly radioactive interfacial crud at the boundary between the two liquors.

Two analyses of liquor from the bottom of HAPWB indicated it contained less than 370 TBq beta in the aqueous liquor and its transfer to the sea tanks pending discharge to sea, as agreed by plant management, was commenced. Unfortunately, as a result of what appears to be a failure of communication between shifts, the tank was assumed to contain aqueous liquors only and the instructions to float off solvent and retain a heel were therefore not carried out. The transfer to the sea tanks commenced at about 21:15 hours on 10 November.

Transfer proceeded normally until about 00:45 hours on 11 November when gamma radiation monitors on the transfer pipework alarmed and the transfer was terminated. The high radiation levels on pipework were reduced by washing through into the sea tank.

After this transfer, sea tank No. 1 was found to contain about 166.5 TBq of beta activity mostly contained in a thin layer of solvent and crud floating on top of a much less active aqueous liquor. Despite the temporary high radiation levels on pipework, no person received a significant radiation dose. There remained, however, an enhanced dose rate of about 0.05 mSv/h around the sides of sea tank No. 1 which caused the 7.5 μ Sv per hour limit for the nearby boundary of the Controlled Area to be exceeded and required the boundary to be temporarily extended.

It was decided to discharge most of the aqueous liquor in sea tank No. 1 to sea before transferring the much smaller quantity of aqueous liquor, solvent and crud remaining up a 5/7.5 cm emergency return line to a tank in B211. This was duly carried out and resulted in about 0.2 TBq of beta activity being sent to sea.

The transfer of the remaining liquor was then carried out which involved pumping it through the normal 25.4 cm pipework to the sea discharge lines for some distance and then up the 5/7.5 cm return line to B211. After transfer the pipework was washed through into B211 but radiation levels on the 25.4 cm pipe work remained high at about 20 mSv per hour. It was considered that this was due to the low flow rate achievable in pumping up the 5/7.5 cm line (about 4.5 m³/h) being inadequate to flush remaining crud and solvent from the 25.4 cm pipework.

It was decided to flush this material to sea by discharging a sea tank (at the normal flow-rate of about 400 m³/h) through the 25.4 cm pipework and down No. 1 old sea line. This was carried out in the early hours of Sunday, November 13 and thereby reduced radiation levels on the pipework gamma radiation monitor to about 6 mSv/h. During the flushing operation the radiation level at the sea discharge valve exceeded 0.05 Sv/h, but prompt evacuation prevented workers stationed there from receiving any significant radiation doses.

For reasons not yet completely understood the radiation level on the pipework rose to high level (of some mSv/h) on a number of further occasions and further flushing was carried out that day to reduce them with the last being at about 8 p.m.

A further flushing of the pipework was carried out late on Wednesday, November 16th, after the gamma radiation level on the pipework rose to several mSv/hour. This process reduced the level to about 4 mSv/hour.

A solvent slick was observed on the surface of the sea on Friday, 18 November, but before it could be dispersed with detergent the wind changed to on-shore and, on Saturday, 19 November, deposited it over a small length of the shoreline adjacent to the site.

A total of 59 TBq (1 600 Ci) including 45 TBq (1 214 Ci) ^{106}Ru had been released to the sea. Maximum irradiation levels were 270 mSv per hour on dried organic material deposited on the beach. A great number of measurements resulted in dose rate of more than 0.1 mGy/h. The access to the beaches was temporarily closed.

3.4.6 Release of uranium powder from a conversion furnace to a scrubber system. ASEA Atom, Vasteras, Sweden, 11 January 1989

The incident started in the reduction furnace, when a valve in the pneumatic filter-cleaning system malfunctioned; the resulting pressure increase opened the relief valve [21]. The relief valve failed to reseat properly, while the furnace gas supply did not stop. This resulted, over a one-hour period, in about 200 kg of 3% enriched uranium following the fumes from the furnace to the scrubber system and subsequently to the storage tanks, via the two 1 micrometer filters, both of which were malfunctioning.

Triggered by the sludge-level alarm, the storage tank was emptied three times normally within a period of four hours. After the last emptying the alarm signal was not deactivated which led to the solution being flushed onto the floor one hour later (a correct design function). The main conclusions of the event and the subsequent investigations were that the installed safety system functioned as designed, and that the instances of plant item malfunctioning were mainly due to quality assurance failures.

Under a lesson learned heading the most significant entries are:

- however obvious the importance of quality assurance is, it takes special care and consideration when applying it to safety;
- a well-trained operator of the Quality Assurance Programme for Safety is essential for the effective and smooth operation of compliance assurance;
- careful analysis of the criticality safety aspects of this incident has not indicated any need to revise the basis for approval. (The occurrence of two disturbances, each of which have a low frequency of occurrence, and are independent of each other, will not result in criticality.)

3.4.7 Internal exposure of workers at the Tokai Reprocessing Plant, 27 December 1993

Four workers were exposed internally while they were replacing a filter element of the vacuum filter installed in the sampling system connected to the plutonium receiving vessel of the rework process of the Tokai Reprocessing Plant on 27 December 1993. At the time of incident, operation of

the TRP had been stopped for routine maintenance since 5 December 1993. The cause of the internal exposure was that the four workers inhaled plutonium particles dispersed from the filter element in the vacuum distribution room. The floors of the vacuum distribution room and subsequent airlock area were contaminated by this radioactive release. The bio assay analysis results on 11 January 1994, showed that the maximum estimated internal exposure committed over 50 years was 90 mSv effective dose equivalent and 1 700 mSv tissue dose equivalent for one of the four workers. Both dose equivalents exceeded the legal dose limit (50 mSv/y and 500 mSv/y, respectively).

Result of investigation revealed that the root cause was basically a violation of rules concerning working procedures.

3.4.7.1 The root causes of the dispersion of plutonium particle and spread of contamination

According to the task planning procedure, when replacing the filter element of the vacuum filter installed in the vacuum distribution room, workers are supposed to seal the removed filter element in multiple vinyl bags. However, a vinyl sheet was used instead, resulting in insufficient containment.

Furthermore, the conveying of the insufficiently contained filter element from the vacuum distribution room and the second wrapping of this filter element in the airlock area resulted in the spread of plutonium particles from the insufficient containment.

The task planning procedure requires contamination surveys to be performed “at appropriate intervals”. However, the phrase “at appropriate intervals” to confirm the contamination level at each stage of the task was not properly taken into account.

3.4.7.2 The root causes of internal radiation exposure of workers

The internal radiation exposure of main workers B and D, who were engaged in replacement of filter element, occurred through exposure to contaminated air due to dispersion of plutonium particles from the filter element when workers were engaged in wrapping this element with a vinyl sheet in the vacuum distribution room.

The internal radiation exposure of assistant worker C and group leader A occurred when they were engaged in the second wrapping of the insufficiently contained filter element in the airlock area.

The internal radiation exposure of group leader A was due to the fact he was expected only to perform safety monitoring in the location which would not normally be subject to contamination and was therefore not wearing a face mask. In spite of these conditions he performed the second wrapping of the insufficiently contained filter element. Subsequently he was exposed to contaminated air.

3.4.7.3 Countermeasures to prevent recurrence were as follows:

- In order to provide even greater protection against the dispersion of radioactive materials, a containment system, such as a bag-in/bag-out system, shall be used when replacing a filter element. This will ensure a safe containment. The manual shall be revised in accordance with the changeover of containment system and shall be improved for clarifying important points and ensure contamination survey.

- Manuals concerning the work with unsealed plutonium materials shall be revised to prevent occurrence of similar incidents.
- Furthermore, safety training shall be performed to assure that revised directions of the manual are followed.
- A radiation safety checklist shall be developed for the improvement of preliminary evaluation of any possible contingencies.
- The plant technical specifications shall contain a policy for the development of plant operating procedures for which strict adherence is required.

3.5 Loss of power supply

3.5.1 Loss of power supply at La Hague, 15 April 1980

On Tuesday, 15 April 1980 at 8:45 a.m. [18], the COGEMA reprocessing plant at La Hague was operating normally when a short circuit in the electric cable run from the medium voltage (15 kV) station caused a fire which essentially destroyed the site power distribution board control room; this short circuit also put out of use one of the two 90 kV/15 kV transformers which transmit the power to the plant from the Électricité de France (EDF) grid. This fire made it impossible to use the site internal power supplies, which consist of four sets of installed generators, each of about 2 MVA, because the control panel for these was also put out of use. The sensitive installations, i.e. fission product storage and plutonium oxide conditioning, were successively connected within about 30 minutes to mobile generating sets kept in reserve for this purpose. These measures are part of the site emergency plan for loss of normal external and internal power supply. The controlled zones were also evacuated to prevent possible personnel contamination caused by the lack of ventilation. The evacuation was ordered by means of a site internal telephone system powered by batteries. Within two hours the fire was completely extinguished by the site firemen. Restoration of the electric power to the plant from the normal EDF 90 kV grid through the intact transformer was completed the same day by making a special connection. Some additional mobile power generating sets were used to complete reprocessing operations which were ongoing at the time of the accident.

3.5.1.1 Radiological consequences

The accident and the subsequent evacuation from the controlled zones caused no physical damage to the operating and maintenance personnel.

The systematic air sampling carried out every few hours showed no general contamination of the buildings except for slight air activity in one room of one building. This disappeared as soon as the ventilation system was restarted. The associated surface contamination was cleaned up during the day of 17 April. The air samples also demonstrated that there had been no discharge of radioactivity from the stacks.

3.5.1.2 Restarting conditions

On 21 April 1980, power was supplied to the plant in the following manner:

- the power supply for the normal operation of the plant was provided from the EDF 90 kV grid by a temporary connection;

- a first emergency power supply was provided by a set of fixed generators capable of maintaining the power necessary for the safety of the installation;
- a second emergency power supply was provided by a set of mobile generators and connection through a temporary line to the EDF 15 kV country grid.

In these conditions, and after regulatory inspection of the system, restart of the plant was authorised on 22 April 1980.

3.6 Incidents of external origin

3.6.1 Flooding of a uranium mine (Canada), April 2003

In April 2003 there was a significant inflow of water into the McArthur mine in Canada. Workers were evacuated temporarily. The uncontrolled inflow of water greatly exceeded the dewatering contingency pumping rate, and there were no immediate means to reduce or eliminate the excess inflow. The situation continued for several weeks, while various actions were taken to cope with the problem. As more water was pumped from the mine, additional treatment facilities for the effluent had to be installed. The impact assessment is underway. Operation has resumed before the end of 2003.

Though its economic consequences were probably weighty, this incident was not major from the safety point of view. It however clearly illustrates the assertion of the beginning of Chapter 5 that uranium mines have the same safety and environmental issues as other mines.

4. References

- [1] Burrows, S. and Hagemayer, D. (2002), "Occupational Radiation Exposure at Commercial Nuclear Power Reactors and Other Facilities 2001", NUREG-0713, Volume 23.
- [2] Stratton, W.E. (1989), "A Review of Criticality Accidents", DOE/NCT-04, March.
- [3] ORNL (1978), "Nuclear Safety Guides", TID-7016, Rev. 2, ORNL/NUREG/CSD, US Report, 6 June.
- [4] ICCP (1979), "Criticality Event of October 17, 1978", CONF-790561-1.
- [5] Los Alamos (2000), "A Review of Criticality Accidents", LA-SUB-00-44.
- [6] Hughes, T.G. (1972), "Criticality Incident at Windscale", Nuclear Engineering International, February, p. 95.
- [7] ICCP (1980), "Criticality Event of October 17, 1978", Nuclear Safety, Vol. 21, No. 5 September-October, pp. 648-653.
- [8] Bouzigues, H. and Mesin, M. (1978), "Fundamentals of UF₆ Transportation", CSNI Specialist Meeting on the Safety problems associated with the Handling and Storage of UF₆, Boekelo, the Netherlands, June, OECD, Paris.

- [9] Price, A. (1978), "Safety Aspects of Uranium Hexafluoride Manufacture and Reconversion at Springfields Works", CSNI Specialist Meeting on the Safety problems associated with the Handling and Storage of UF₆, Boekelo, the Netherlands, June, OECD, Paris.
- [10] Legeay, A.J. (1978), "Handling of UF₆ in the United States", Gaseous Diffusion Plants, CSNI Specialist Meeting on the Safety problems associated with the Handling and Storage of UF₆, Boekelo, the Netherlands, June, OECD, Paris.
- [11] US NRC (1986), "Rupture of Model 48Y UF₆ Cylinder and Release of Uranium Hexafluoride", NUREG-1179, February.
- [12] Reactor Fuel Reprocessing (1964), Vol. 7, No. 4, Fall.
- [13] NII (1974), "Report by the Chief Inspector of Nuclear Installations on the incident in Building B204 at the Windscale Works of British Nuclear Fuels Limited on September 26, 1973", London – Nuclear Installations Inspectorate, Cmnd 5703, July, HMSO, London.
- [14] Gray, L.W. (1978), "An Explosion and Fire during Conversion of Liquid Uranyl Nitrate to Solid Uranium Oxide", Nuclear Safety, Vol. 19, No. 1, January-February, p. 91.
- [15] Perkins, W.C., Durrant, W.S. and Hyder, M.L. (1977), "The Safety of UO₂ production in the A Line at the Savannah River Plant", Report DP 1443 UCIO (TID 4500), March., p. 64
- [16] GRS (1990), Information provided for the CSNI Working Group on the Safety of the Fuel Cycle, January, OECD, Paris.
- [17] Nakamura, H. and Omori, E. (2000), "Safety evaluation of Tokai Reprocessing Plant", International workshop on the safety of the nuclear fuel cycle, Science Museum, Tokyo, Japan, 29-31 May 2000.
- [18] CSNI, Reports on incidents and accidents in France, presented at annual meetings of the NEA Committee on the Safety of Nuclear Installations.
- [19] HSE (1980), "The Leakage of Radioactive Liquor into the Ground at BNFL Windscale", Health and Safety Executive, 15 March 1979.
- [20] HSE (1983), "The Contamination of the Beach Incident at British Nuclear Fuels Limited, Sellafield", Health and Safety Executive, November 1983.
- [21] CSNI WG, "Report on incidents in Sweden, presented at the annual meeting of CSNI Working Group on the Safety of the fuel Cycle", SEN/SIN(89)51, Summary Record of the 10th Meeting of the Working Group on the Safety of the Nuclear Fuel Cycle, 11-12 September 1989, Paris, France, Item 3.10.4.

MAIN CONCLUSIONS

1. General context of the past decade

The decade since the previous edition of this report (last issued in 1993) has been a period of relative stability, with no important increase in the number of nuclear power plants. The main reason is the past overestimation of needs, which led to general overcapacity. Political considerations based on public acceptance problems have certainly also been an aggravating factor. Between 1991 and 2001 however, the number of reactors in service in OECD countries increased from 321 to 360, the total installed power from 264 to 304 GW and electricity produced from 1 603 to 2 185 TWh, more than 36% increase. As for December 2002, 11 power plants were being built for nearly 10 GW installed power and 27 more were ordered or planned for more than 32 MW installed power. Similar figures can be found for the whole world, increase from 424 to 441 reactors, and as for December 2002, 32 power plants were being built for nearly 27 GW installed power. Though these figures are much lower than what could be imagined ten or twenty years ago, they are still far from indicating a decline.

Present situation is rather contrasted. On the one hand, several countries have settled a moratorium on the building of new nuclear power plants (Spain and Switzerland for instance) and some others have announced plans to curtail nuclear plant operations (for example, Sweden, Netherlands, Germany, and Belgium). Closure is expected to take place more or less at the end of the normal lifetime of the plants, which sends forth the realisation to several decades for most of them. The notable exception is Sweden, which had scheduled the closures of all its reactors between 1980 and 2010. Only one reactor has been closed in 1999 and recent situation of lack of energy and associated high prices in the whole Scandinavian region does not presently seem to allow the immediate closure of a second one, which had been decided for 2001, then postponed to 2003.

On the other hand there are clear signs of increases. Finland has decided in 2003 the building of a new nuclear power plant after a democratic decision process, and has passed the order in 2004. People's Republic of China has begun to implement a substantial programme, some moves in United States show a renewed interest for nuclear generation. France begins to prepare the replacement of its present fleet. Some experts consider that nuclear generation is the only way to fulfil Kyoto requirements regarding greenhouse effect gas reductions.

This is not the place for previsions, but nuclear fuel cycle safety should be prepared to deal with quite different situations following the main tendency of next decade.

2. General view of nuclear safety during the past decade

The past decade has seen a number of changes, in both technical and policy areas, in the nuclear power generation and the associated fuel cycle. Nevertheless, during this period more than 400 nuclear power plants totalling a power of more than 300 GW_e operated with no major safety problem. The corresponding uranium (around some 60 000 tonnes each year) was mined, then purified, enriched when necessary, converted and installed in fuel assemblies in industrial scale facilities. Once used in reactors, the fuel was stored and for part of it reprocessed, some MOX fuels were assembled and sent

to reactors where they generated electricity. These operations required quite numerous transport operations to be performed, including shipping transports between Japan and Europe. Yet no really significant event resulted from the operation and maintenance of the industrial scale facilities (some significant events occurred outside the industrial electricity generation field – more on these further on). This shows that the fuel cycle industry has now reached a full maturity status and that nuclear safety is adequately mastered.

This has been made possible mainly because of the soundness of the safety principles implemented, based on the defence in-depth concept. There was no need to change or add something – only the processes and the equipment had to be fully mastered to get reliable and safe (better corrosion control is an important progress in reprocessing, for example). This explains why there is no really major change in the presentations made in this report. Some clarification of concepts have occurred (in ventilation and containment areas for instance), but without any change in the basic philosophy.

An important evolution, which does not show when detailing safety principles and measures, was the continuous reduction in exposure to workers and discharges to atmosphere or waters. This is true as well for reactor operation as for fuel cycle facilities operation. All operators have done their best to reduce exposure, by design when possible, and by implementing the ALARA principle. The increased reliability of equipment plays an important role, since it means less maintenance and thus less exposure. The operators have also optimised treatments on discharged flows and sometimes boldly changed or installed some processes especially for the purpose of reducing discharges.

The results are quite obvious: displayed figures show considerable reductions as well on exposures as on discharge levels. Impact on public and workers is everywhere well below levels recommended by ICRP in its most recent reports. These results are a clear indication of maturity.

Another important evolution, which does not show either, is the growing concern of regulators about what is called the human factors. Though this is not really a new subject – it was considered that human factors were involved in the Three Mile Island event, for instance – more emphasis was given after the Chernobyl event, when the concept of “safety culture” was put forth for the first time. More simply, when processes and equipments get more reliable and safe, the main remaining root cause of undesirable events – though with reduced probability – appears to be human failure. Well structured industrial companies can make use of convenient resources to train and motivate the operators and settle efficient organisations. However, experience feed-back shows that these companies are not completely sheltered from such issues. For instance, the falsification of data at the MOX Demonstration Facility at Sellafield or the social difficulties at the Dampierre-en-Burly power plant in France, though both of them had no safety consequences, justify the concern of the regulators on this topic.

It is of course a more difficult issue for smaller companies operating either pilot or research facilities. They are not really part of the fuel cycle facilities, but very close to them, treating the same products and operating similar processes – this is the reason why they are in the scope of this report. It has to be noted that the two main events of the decade in fuel cycle facilities occurred for the first one in a pilot plant (bitumen fire at the PNC facility in March 1997, INES level 3) and for the second one in a small scale facility preparing research reactor fuel (criticality event at JCO facility at Tokai mura in September 1999, INES level 4) – that is to say outside the industrial facilities needed for massive electricity generation, and it was reckoned that human factors was involved as one of the main causes in both cases.

Though very few events are actually caused by human factors, if one wants to try to prevent them as much as possible, the subject is a real challenge, not only for the fuel cycle industry or the

nuclear power plants, but for many branches of activity where processes and equipment safety has improved in such a way that human causes become dominating. The most visible other activity is transportation, be it on earth, sea or by air, but many other ones could be quoted.

INES, the international nuclear event scale, is now fully in place as well in fuel cycle facilities as in transport operation. It has to be recalled that it is a communication scale – not a safety scale. It fulfils its role of providing fast, normalised and easily understandable information on nuclear events to the media and the public.

3. Evolution by area

In the mining and milling area, there has been additional interest in the in situ leaching (ISL, or solution mining) technique, where technically feasible, for uranium extraction. A principal attraction in ISL is the considerable reduction in residues after uranium extraction. There is no large deposit of mill tailings after the mine is closed. However, underground mining, and open-pit mining, remain as the predominant modes of uranium mining. In some countries, notably the United States and Europe, but also in Africa, mining has essentially stopped in all low grade mines, too costly to operate. Market price is low, because the nuclear power business is rather static. Moreover the most striking effect on mining and milling has been the reaction to the availability of enriched uranium, after suitable downblending, from the former weapons program of Russia.

There have been some interesting developments in the enrichment stage of the fuel cycle. Laser enrichment has not yet lived up to its potential. There is still some ongoing research and development in the SILEX method. The AVLIS laser method, although the beneficiary of more than one billion US dollars of research, has largely been shelved all the world over, because technological problems seem difficult to solve at a reasonable cost. The nuclear power plants, in their desire to go to less costly higher burn-ups, are ordering higher enrichments from the existing enrichment plants. The centrifuge is gradually gaining dominance over the diffusion method as the preferred mode of enrichment, mainly for economic reasons, because of the very high energy consumption of the diffusion process but also because of the higher flexibility regarding enrichment of reprocessed uranium. One of the two gas diffusion facilities in the United States (i.e. Portsmouth, Ohio) has been, at least temporarily, shut down. The operator of the other US diffusion plant, the US Enrichment Corporation, is pursuing a centrifuge plant. AREVA, mother company of COGEMA has entered on 24 November 2003 the process of acquiring 50% of Enrichment Technology Company that gathers technical, R&D and commercial activities of URENCO in the field of uranium enrichment for nuclear fuel by centrifugation. This agreement is subject to approval of the European Union and concerned governments expected for the end of 2004. AREVA plans to install a Georges Besse 2 plant in Tricastin that should enter into production in 2007 and reach full capacity around 2016. This confirms that the centrifuge method is gradually replacing diffusion process.

Uranium fuel fabrication plants have not changed much over the past decade. MOX fuel fabrication capacity has increased through the commissioning of MELOX at Marcoule and SMP at Sellafield. The handling of plutonium oxide does not seem to create safety problems in plants designed for this use, applying the same safety principles than the ones implemented in plutonium workshops of reprocessing plants. The decision to convert surplus plutonium from the weapons program into MOX fuel has been taken in the United States. No further positive interest in reprocessing has yet been shown in the United States.

Although the permanent disposal of HLW is not within the scope of this report, it inevitably has an effect on stages of the fuel cycle that are within scope. This includes on-site dry storage, and transportation. If a nation does not have a permanent disposal site (e.g. the United States) then on-site

storage becomes more and more of a factor. Many reactor sites are building dry storage sites close to the reactor facility, generally within the reactor exclusion area boundary.

Regarding reprocessing plants, UP3-A and UP2-800 at La Hague have reached their nominal capacity, THORP at Sellafield has been commissioned and has also reached its nominal capacity, all of them with very good safety records. Construction of Rokkasho Reprocessing Plant is on its way towards commissioning in 2006.

Transportation of spent fuel can arise in two ways. It is possible that spent fuel might be stored at an AFR interim storage facility before being reprocessed or pending the availability of a permanent solution. Alternately, given the availability of a permanent disposal site, then fuel would be transported, sometimes at a great distance, from the reactor to the site. In either case there is the question of safe transportation of this HLW. Though their properties have been demonstrated in extreme tests and actual accidents have never led to radioactive discharge, added interest is seen in resistance of transport casks to a variety of incidents and accidents, or perhaps terrorism that the casks might experience en route. Research is continuing on this topic.

Decommissioning of many nuclear facilities already took place during penultimate decade, with no special safety problem. Last decade saw these operations going on at their pace, with no more safety problem, for instance in US military facilities, in British Dounreay reprocessing plant, in French back-end facilities of Marcoule and La Hague. Lessons learnt up to now have made it possible to establish a set of practical rules that allow the results to be obtained. The evolution of technologies makes things rather easier, for instance the use of electronic dosimeters with adjustable instantaneous alarms, of computerised systems that allow visualising dose rate and the progresses of robots.

4. General conclusion

One can say that the results of past decade are satisfactory; fuel cycle industry has reached a maturity that brings it at least to the level of the best conventional dangerous industries. The field of nuclear safety is such that the fight against undesirable events is never ended, and preceding appreciation is in no way a reason to loosen efforts, on the contrary. Safety culture results from a permanently questioning attitude that has to be unceasingly encouraged. This is the only way to keep results at the very high level they have reached and still try to improve them.

Appendix I

**FUEL CYCLE FACILITY LISTING OF OECD COUNTRIES
STATUS 2002-2003**

Uranium ore processing (in tHM per year)

Country-Site	Production capacity	Product process
Canada		
Rabbit Lake, Saskatchewan	6 500	U_3O_8
Key Lake, Saskatchewan	7 200	U_3O_8
McLean Lake, Saskatchewan	3 600	U_3O_8

Uranium refining (in tHM per year)

Country-Site	Production capacity	Product process
Canada		
Blind River, Ontario	18 000	U_3O_8 to UO_3
France		
Malvési	14 000	$U_3O_8 - UF_4 + U$

Uranium conversion to UF_6 as for May 2003 (in tHM per year)

Country	Owner/Controller	Plant Name/Location ^{a)}	Nominal Capacity
Brazil	IPEN	São Paulo	90
Canada	Cameco	Port Hope, Ontario ^{b)}	12 500
China	CNNC	Lanzhou	400
France	COMURHEX (100% COGEMA)	Pierrelatte 1 ^{c)}	14 000
		Pierrelatte 2 ^{d)}	350
Russia	Minatom	Ekaterinburg	4 000
		Angarsk	20 000
United Kingdom	BNFL	Springfields, Lancashire	6 000
United States	Honeywell (previously Converdyn)	Metropolis, Illinois	14 000
Total			71 340

^{a)} Conversion of U_3O_8 to uranium hexafluoride (UF_6) unless otherwise noted.

^{b)} UO_3 to UF_6 . U_3O_8 is converted to UO_3 as an intermediate step at Blind River, Ontario.

^{c)} UF_4 to UF_6 . U_3O_8 is converted to UF_4 as an intermediate step at the Malvési plant.

^{d)} Conversion of reprocessed uranium to UF_6 .

Enrichment of uranium as for May 2003 (in MSWU per year)

Country	Owner/Controller	Plant name/Location	Nominal capacity
Gaseous diffusion plants			
China	CNNC	Lanzhou	900
France	EURODIF	Tricastin	10 800
US	USEC	Paducah, Kentucky	11 300
		Portsmouth, Ohio (closed since 11 May 2001)	(7 400)
Subtotal			23 000
Centrifuge plants			
China	CNNC	Hanzhong	500
		Lanzhou	500
Germany	URENCO	Gronau	1 462.5
Japan	JNC	Ningyo Toge (closed in 2001)	(200)
	Japan Nuclear Fuel Limited (JNFL)	Rokkasho mura	1 050
Netherlands	URENCO	Almelo	1 950
Pakistan	Pakistan Atomic Energy Commission (PAEC)	Kahuta	5
Russia	Minatom	Urals Electrochemical Integrated Enterprise (UEIE), Novouralsk (formerly Sverdlovsk-44, near Ekaterinburg)	7 000
		Siberian Chemical Combine (SKhK), Seversk (formerly Tomsk-7)	4 000
		Electrochemical Plant (ECP), Zelenogorsk (formerly Krasnoyarsk-45)	3 000
		Angarsk Electrolytic Chemical Combine (AEKhK), Angarsk	1 000
United Kingdom	URENCO	Capenhurst	2 437.5
Subtotal			22 905
Total			45 905

UF₆ conversion to UO₂ (in tHM per year)

Country	Owner/Controller	Plant name/Location	Nominal capacity
Canada	Comeco	Port Hope, Ontario	2 800
France	FBFC (49% COGEMA, 51% Framatome)	Romans-sur-Isère	1 200
Germany	FRAMATOME-ANP	Lingen	500
Japan	Mitsubishi Nuclear Fuel	Tokai mura	450
United States	FRAMATOME-ANP	Richland, Washington	650
Total			5 600

Uranium oxide fuel fabrication as for May 2003 (in tHM per year)

Country	Owner/Controller	Plant Name/Location	Nominal Capacity
Belgium	FBFC (49% COGEMA, 51% Framatome)	Dessel	750
Brazil	FEC (INB)	Resende	100
China	CNNC	Yibin	100
France	FBFC (49% COGEMA, 51% Framatome)	Romans-sur-Isère	820
	SICN (100% COGEMA)	Veurey-Voroise	150
Germany	FRAMATOME-ANP	Lingen	650
India	Nuclear Fuel Complex	Hyderabad	25
Japan	Global Nuclear Fuel – Japan	Yokosuka	750
	Mitsubishi Nuclear Fuel	Tokai mura	440
	Nuclear Fuels Industries	Kumatori	284
		Tokai mura	200
Kazakhstan	Ulba Metallurgical Co	Kamenogorsk	2 000
South Korea	KEPCO Nuclear Fuel Co., Ltd. (KNFC)	Taejon	400
Pakistan	Pakistan Atomic Energy Commission (PAEC)	Kundian	?
Russia	JSC TVEL	Elektrostal	1 020
		Novosibirsk	1 000
Spain	ENUSA	Juzbado	300
Sweden	BNFL/Westinghouse Atom	Västerås	600
United Kingdom	BNFL	Springfields, Lancashire	330
United States	FRAMATOME ANP, Inc.	Lynchburg, Virginia	400
	Westinghouse (100% BNFL)	Hematite, Missouri (closed)	450
		Columbia, S. Carolina	1 150
	FRAMATOME ANP (66% Framatome, 34% Siemens)	Richland, Washington	700
	Global Nuclear Fuel – Americas, L.L.C.	Wilmington, N. Carolina	1 200
Total			13 819

Mixed oxide fuel fabrication as for May 2003 (in tHM per year)

Country	Owner/Controller	Plant Name/Location	Nominal Capacity
Belgium	Belgonucléaire SA	Dessel	37
France	MELOX (50% COGEMA, 50% Framatome)	Marcoule	145
India	DAE	Tarapur	50
Japan	JNC FBR JNC ATR closed in 2001	PFPF Tokai mura PFFF Tokai mura	5 (10)
United Kingdom	British Nuclear Fuels, Ltd.	Sellafield SMP	128
Total			365

Heavy water reactor fuel fabrication as for May 2003 (in tHM per year)

Country	Owner/Controller	Plant Name/Location	Nominal Capacity
Argentina	67% Pecom-Nuclear S.A., 33% CNEA	Ezeiza	160
Canada	Zircatec Precision Industries	Port Hope, Ontario ^{a)}	1 800
	General Electric Canada	Peterborough, Ontario	1 800
India	DAE Nuclear Fuel Complex	Hyderabad	135
		Trombay	135
South Korea	KEPCO Nuclear Fuel Co., Ltd. (KNFC)	Taejon	400
Pakistan	Pakistan Atomic Energy Commission (PAEC)	Chashma	20
Total			4 450

a) Processing of UO₂ only. Conversion of U₃O₈ to UO₃ is performed at Cameco's Blind River plant, and conversion of UO₃ to UO₂ at Cameco's Port Hope plant.

Away from reactor storage of spent fuel (in tHM)

Country-Site	Storage capacity	Storage means
Finland Olkiluoto-Loviisa	1 270	Pool
France Cadarache CASCAD La Hague	180 18 000	Vault Pool
Germany Gorleben Ahaus	3 800 3 960	Metal casks Metal casks
Sweden CLAB Oskarshamn	5 000 (ext. to 8 000)	Pool
Switzerland Würenlingen	3 000	Metal casks
United Kingdom Sellafield	10 000	Pool

Reprocessing plants (in tHM per year)

Country-Site	Production capacity	Starting operation
France		
La Hague UP3-A	1 000*	1990
La Hague UP2-800	1 000*	1993
Japan		
JNC Tokai mura	40**	1977
United Kingdom		
Sellafield THORP	1 200	1994

* Cumulated production administratively limited to 1 700 tHM/year.

** Licensed capacity 210 tHM/year.

World reprocessing of FBR mixed oxide fuel (in tHM)

Plant	Operating period	Reprocessed quantity
Dounreay	1960-1992	>40
La Hague UP2-400	1979-1984	10
Marcoule APM	1974-1990	17
Tokai JNC	1982-2003	>0.1

Appendix 2

GLOSSARY OF TERMS

Actinide series

The group of elements from actinium (atomic number 89) to lawrencium (atomic number 103), which together occupy one position in the periodic table; the series includes the naturally occurring and man-made isotopes of thorium and uranium and of the higher actinides such as neptunium, plutonium and curium.

Activation products

Nuclides which have become radioactive in consequence of bombardment by neutrons or other nuclear particles, for example during irradiation in reactor.

Alpha particle

A positively charged particle emitted in the decay of some radioactive nuclei, especially nuclides of the actinide series; it consists of two protons and two neutrons and is identical with the nucleus of the helium-4 atom. It has a very low penetrating power and hence pure alpha emitters are almost exclusively only a hazard when taken into the body.

Becquerel

International unit of radioactivity, defined as 1 disintegration per second. Related to the old unit of curie (Ci) by $1 \text{ Ci} = 3.7 \times 10^{10}$ disintegrations/second; $1 \text{ Bq} = 2.703 \times 10^{-11} \text{ Ci}$.

Beta particle

An electron or positron emitted in the decay of some radioactive nuclei; it is only moderately penetrating.

Biological shield

Thick walls, of high density material (concrete, heavy concrete, cast iron or lead) interposed between a source of radiation and personnel, and designed to reduce the level of the gamma radiation to an acceptable level. Alpha radiation has low penetrating power and never needs biological shielding, and neutron requires the use of specific materials (for instance hydrogenated materials such as wood, plaster or polyethylene, or neutron absorbers such as boron or hafnium).

Breeder reactor

A reactor that creates more fissionable fuel than it consumes; the new fissionable material is created by capture in fertile materials of neutrons from fission.

Burn-up

The amount of fissile material in a reactor which is consumed by fission or neutron capture, expressed as a percentage of the original quantity of fissile material present; alternatively, the energy obtained per unit mass of fuel, expressed generally as MWd/tHM.

Calcination

Evaporation of a waste solution to dryness and heating the residue so as to convert the waste to the oxides of the metallic constituents.

Chain reaction

A self-sustaining reaction in which each process results in the production of the agent necessary to cause a further identical process to occur; for example, the neutron-induced fission of uranium-235 results in the liberation of neutrons which can cause the fission of further uranium-235 atoms.

Cladding

Fuel elements in most nuclear reactors are made of fissile material clad in a protective metal sheathing, which is relatively resistant to the physicochemical conditions that prevail in a reactor core; the function of the cladding is to prevent corrosion of the fuel and escape of fission products to the coolant of the reactor and the storing pool.

Cladding waste, cladding hulls

In certain reprocessing plants, the operation begins with the disassembling of fuel bundles or assemblies and the chopping up of fuel elements or rods; the fuel is then leached out from the fragments. The remaining residues, principally the activated cladding fragments called "hulls" and the insoluble fuel residues, constitute the cladding waste.

Conditioning

Those operations which transform the solid or liquid by-products of a process that could disperse radioactivity or generate radiations into stable forms suitable for transport and/or storage and/or disposal in safe conditions.

Cooling (time)

A term used in supplement to the usual meaning to describe the process of storing radioactive material, such as irradiated fuel elements, in order to allow the radioactivity to decay.

Criticality

A condition in which a sufficient quantity of fissile material is assembled in the right arrangement and conditions for a self-sustaining chain reaction to take place.

Daughter product

A nuclide formed by the radioactive decay of another nuclide; a synonym for decay product.

Decay heat

Heat produced by the decay of radioactive nuclides.

Disposal

The release or emplacement of waste materials without the intention of retrieval.

Dose

The mean energy imparted by radiation per unit mass of matter; it is expressed numerically in gray, symbol Gy, as the unit of radiation of the International System equal to the joule per kilogram. $1 \text{ Gy} = 1 \text{ J/kg} = 100 \text{ rad}$.

Dose equivalent

The amount of absorbed radiation per unit mass of matter; it is expressed numerically in sievert, symbol Sv, as the unit of dose equivalent of the International System. $1 \text{ Sv} = 100 \text{ rem}$.

Dose equivalent limits

The radiation exposure limits recommended by the International Commission on Radiological Protection (ICRP) to limit the exposure of human beings to ionizing radiations.

Fast neutrons reactor

A reactor in which the majority of fissions are produced by neutrons having energies of the same order of magnitude as those which they possess when they are produced in the fission process; often quoted as FBR for fast breeder reactors.

Fissile material

Material capable of undergoing fission.

Fission

The splitting of a nucleus usually into two approximately equal fragments; the process is accompanied by the emission of neutrons and the release of energy. Neutron-induced fission is the most important, but fission of certain nuclides may occur spontaneously.

Fission products

Nuclides produced during fission, either directly or by the disintegration of the fission fragments.

Fission reactor

A reactor in which energy is generated by the fission of heavy nuclei; includes both thermal and fast reactors.

Fuel cycle

The various stages involved in supplying fuel for nuclear power reactors and any subsequent treatment and disposal operations; it includes uranium mining, milling and enriching, fabrication of fuel elements, their use in a reactor, fuel reprocessing, waste treatment and storage. Use in a reactor and waste disposal are generally considered as different subjects of their own and are not included in the fuel cycle.

Gamma-rays

Electromagnetic radiation with short wavelength (10^{-8} to 10^{-11} cm) which is emitted by the nucleus. The emission of gamma-rays accompanies the disintegration of many alpha or beta emitters. The penetrating power of gamma-rays is a function of their energy.

Half-life

The time in which half the atoms of a particular radionuclide disintegrate, a characteristic constant of each radionuclide; half-lives vary from millionths of a second to billions of years.

Heavy nuclides

Term which refers for the purpose of this report to isotopes of elements with atomic number greater than 80; all actinides and their daughter products are included in this group.

Irradiated fuel

Nuclear fuel removed from a reactor following irradiation, which is no longer economically usable because of depletion of fissile material, poison build-up, or radiation damage.

Isotope

One of several nuclides with the same atomic number, but with different atomic mass, and hence differing in the number of neutrons; isotopes usually have almost identical chemical and physical properties.

Magnox

A magnesium alloy used as the cladding material in some gas-cooled reactors. The name is also used for reactors using this type of fuel.

Mill tailings (uranium)

Solids with very low uranium content produced in the milling of uranium ores.

Mixed oxide fuel

Reactor fuel which contains more than one type of fissile nuclide, both being in the form of oxides. Most commonly referred to fuel containing both uranium oxide and plutonium oxide, named MOX.

Pool (cooling pool)

A water filled pool for storing irradiated fuel after removal from the reactor or conditioned highly active waste (HLW); storage allows time for the radioactivity to decay. The pool water provides cooling and shielding.

Rad

A formerly used unit of absorbed dose, equal to an absorbed energy of 10^{-2} joule per kilogram; the SI system uses the gray as the unit of absorbed dose. 1 rad = 0.01 Gy.

Radioactive effluent

Radioactive waste discharged to the environment under controlled conditions; effluents can be either gaseous or liquid.

Radioactive waste

Any material containing or contaminated with radionuclides at concentrations greater than the values that the competent authorities would consider acceptable in materials suitable for uncontrolled use or release, and for which there is no foreseen use.

Radioactivity

Process whereby certain nuclides undergo spontaneous disintegration in which energy is liberated, generally resulting in the formation of new nuclides. The process is accompanied by the emission of one or more types of radiation, such as alpha particles, beta particles and photons (electromagnetic radiation).

Radiolysis

The chemical decomposition of molecules by ionising radiation.

Reprocessing (reprocessing-recycling)

A chemical process, the purpose of which is to extract for further use uranium and plutonium from spent fuel; this operation also results in the separation of radioactive waste products (mainly fission products).

Separative work

A term used in the process of isotope enrichment; it is in relation to the amount of work necessary to increase the isotopic content of natural uranium in uranium-235 (SWU = separative work unit).

Sievert (Sv)

International dose equivalent unit used in radiological protection. Doses in Sv are obtained by multiplying doses expressed in gray by appropriate factors that take into account the biological effects of the various types of radiation, the dose distribution within the body and any other necessary corrections. The SI systems and ICRP proposed the use of the sievert as a new dose equivalent unit replacing the rem. $1 \text{ Sv} = 100 \text{ rem}$.

Specific activity

The activity per unit mass or volume.

Spent fuel

Same as irradiated fuel.

Storage

The emplacement of materials or items with the intent and in such a manner that they can be retrieved later.

Thermal reactor

A reactor in which the chain reaction is sustained primarily by fission brought about by thermal neutrons, i.e. neutrons which are in thermal equilibrium with the material in which they are moving. Such reactors use a moderator to slow down the neutrons produced in fission have to be slowed down to energies in the thermal range by a moderator substance that is used in such reactors. Examples are GCR for gas-cooled reactors, AGR for advanced gas cooled reactors, both generally moderated by graphite and LWR for light water reactors (PWR for pressurised water reactor and BWR for boiling water reactor) moderated by water.

Transmutation

The conversion of long-lived nuclides into much shorter-lived or even stable, i.e. non-radioactive nuclides, generally by fission.

Transuranium elements

Elements with atomic numbers greater than 92; they include neptunium, plutonium, americium and curium.

Treatment (liquid and gaseous effluent)

Those operations which concentrate nuclides in a reduced volume and accordingly reduce the activity of the remaining material, thus allowing its dispersion or recycling.

Waste management

The series of operations (including storage) carried out on the waste from arising up to disposal included.

Waste rock

Rock that does not bear any ore, that has to be mined to give access to ore.

Appendix 3

LIST OF ABBREVIATIONS

ACC	Atelier de Compactage des Coques, La Hague, France
ADU	Ammonium Diuranate
AEA	Atomic Energy Agency-Technology, United Kingdom
AFR	Away From Reactor fuel storage
AGR	Advanced Gas Reactor
ALARA	As low as reasonably achievable, economic and social factors being taken into account
ALARP	As low as reasonably practicable (same as ALARA plus economic and social factors)
APM	Atelier Pilote Marcoule, France
AT-1	Pilot FBR reprocessing plant, La Hague, France
AREVA	mother company of COGEMA and FRAMATOME-ANP
AUC	Ammonium Uranyl Carbonate
AUPuC	Ammonium Uranyl Plutonyl Carbonate
AVLIS	Atomic Vapour Laser Isotope Separation
AVM	Atelier de Vitrification de Marcoule
BN	Belgonucléaire, MOX fabrication, Dessel, Belgium
BNFL	British Nuclear Fuels Ltd, United Kingdom
BPEO	Best Practicable Environmental Option
BWR	Boiling Water Reactor
CANDU	Canada Deuterium Uranium reactor
CEC	Commission of European Community
CLAB	Central Interim Storage Facility for Spent Nuclear Fuel of Sweden at Oskarshamn
COGEMA	Compagnie générale des matières nucléaires (AREVA Group), France
COSR	Continued Operation Safety Report
CPF	Chemical Processing Plant, Tokai mura, Japan
CRO	Clean Reject Oxides
CRUD	Chalk River Unidentified Deposits
CSNI	Committee on the Safety of Nuclear Installations
DBE	Design Basis Event
DF	Decontamination Factor
DOE	Department of Energy of the United States
DOG	Dissolution Off-Gases
DRO	Dirty Reject Oxides
DSRP	Dounreay Site Restoration Plan
DU	Depleted Uranium
DWPF	Defense Waste Processing Facility at Savannah River (United States)
EIA	Environmental Impact Assessment
EU	European Union
Eurochemic	Reprocessing plant of United Reprocessors Co, Dessel, Belgium
FBR	Fast Breeder Reactor

FP	Fission Products
GC	Gas Centrifuge
GCR	Gas Cooled Reactor
GDP	Gaseous Diffusion Plant
G(H ₂)	number of molecules of H ₂ produced per 100 eV of irradiative energy absorbed
GW	Gigawatt, unit of power, 1 billion watt
GWd	Gigawatt during one day unit of energy
GW _e	Gigawatt under electrical form
GW _y	Gigawatt during one year, unit of energy
HAZOP	HAZard and OPerability study or survey
HEPA	High Efficiency Particulate filter
HEU	High-Enriched Uranium
Hex	Uranium Hexafluoride
HF	Hydrogen Fluoride or hydrofluoric acid
HLLW	High activity Level Liquid Waste
HLW	High activity Level Waste
HSE	Health and Safety Executive of United Kingdom
HTGR	High Temperature Gas Reactor
HWR	Heavy Water Reactor
IAEA	International Atomic Energy Agency
ICRP	International Commission on Radiological Protection
IDR	Integrated Dry Route
IMO	International Maritime Organisation
INEEL	Idaho National Environmental and Engineering Laboratory, United States
INEL	Idaho National Engineering Laboratory now INEEL
INES	International Nuclear Event Scale
ISL	In-situ leaching
ISO	Short name of Organisation internationale de normalisation (International Organization for Standardization)
JCO	Japan Nuclear Fuel Concersion Co.
JNC	Japan Nuclear Cycle Development Institute
JNFL	Japan Nuclear Fuel Ltd.
JRC	Joint Research Centre of the European Commission at Ispra, Italy
KfK	Kernforschungszentrum Karlsruhe, research centre, Germany
LAVA	Storage facility for HLLW at Karlsruhe, Germany
LEU	Low-Enriched Uranium
LMFBR	Liquid Metal Fast Breeder Reactor
LWR	Light Water Reactor
LWTF	Low Level Radioactive Waste Treatment Facility Tokai, Japan
MAGNOX	Gas cooled – uranium metal reactors in United Kingdom, from the name of the cladding material
MDF	MOX Demonstration Facility Sellafield
MELOX	MOX plant, Marcoule, France
MFFF	Mox Fuel Fabrication Facility
MIMAS	MIcronized MASTer blend
MOX	Mixed Oxide of uranium and plutonium
MSK	Medvedev Sponheueur and Karnik: intensity scale for earthquakes
MSWU	Million SWU i.e. million Separative Work Unit
MW	Unit of power, 1 million watt
NEA	OECD Nuclear Energy Agency
NFS	Nuclear Fuel Services, United States reprocessing and fuel fabrication company

NII	Nuclear Installations Inspectorate of HSE, United Kingdom
NPP	Nuclear Power Plant
NRC	Nuclear Regulatory Commission of the United States
OECD	Organisation for Economic Co-operation and Development
PAMELA	vitrification process and plant, Dessel, Belgium
PCB	Poly Chloro Biphenyl
pH	Hydrogen potential characterising the acidity of a solution
PNC	Power and Nuclear Fuel Development Co., Japan (now JNC)
PIVER	pilot vitrification plant, Marcoule, France
POCO	Post Operation Clean Out
PUREX	Plutonium Uranium EXtraction process
SBR	Short Binderless Route
SILEX	Separation of Isotopes by Laser Excitation: molecular isotopic separation laser process
SMP	Sellafield MOX Plant
STE3	Station de Traitement des Effluents liquids of La Hague site, France
SWU	Separative Work Unit
SYNROC	SYNthetic ROCK Australian waste solidification process
t	metric tonne
TBP	TriButyl Phosphate
TCE	Tri Chloro Ethane
TDN	Thermal Direct Denitration
tHM	metric tonne of Heavy Metal (uranium and plutonium)
THORP	Thermal Oxide Reprocessing Plant of Sellafield
TRP	Tokai Reprocessing Plant
TRU	Trans Uranic elements
tU	metric tonne of uranium element
TVF	Tokai Vitrification Facility, Japan
UCD	Unité de Conditionnement des Déchets, La Hague, France
UK	United Kingdom
UNH	Uranyl Nitrate Hexahydrate
UOC	Uranium Ore Concentrate (“Yellow cake”)
UP2	Usine Plutonium No. 2 of La Hague site (France) in version 400 tHM/y (UP2-400) or 800 tHM/y (UP2-800)
UP3-A	Usine Plutonium N°3-A of La Hague site, France
US	United States of America
USEC	United States Enrichment Corporation
WAK	pilot reprocessing plant at Karlsruhe (Germany)
WVP	Windscale Vitrification Plant, Sellafield, United Kingdom
Zircaloy	Registered zirconium alloy

OECD PUBLICATIONS, 2, rue André-Pascal, 75775 PARIS CEDEX 16
PRINTED IN FRANCE
(66 2005 16 1 P) ISBN 92-64-01421-7 – No. 54455 2005